



WARNINGS

- When connecting the PS-600G (hereafter referred to as the "PS-G")'s power cord terminals to the PS-G's Terminal Block, check first that the PS-G's power supply is completely turned OFF, via a breaker, or similar unit.
- Whenever changing the backlight, to prevent electric shocks and burns, be sure to turn OFF the PS-G's power and wear protective gloves.
- Except to change the backlight, do not open or remodel the PS-G unit, since it may lead to a fire or electric shock.
- Do not use power beyond the PS-G's specified voltage range. Doing so may cause a fire or an electric shock.
- Do not use the PS-G in an environment where flammable gases are present, since operating the PS-G may cause an explosion.
- The PS-G uses a lithium battery for backing up its internal clock data. If the battery is incorrectly replaced (i.e. its + and - sides are reversed), the battery may explode. Prior to changing the battery, please contact your local PS-G distributor.
- Do not use the PS-G unit as a warning device for critical alarms that can cause serious operator injury, machine damage or production stoppage. Critical alarm indicators and their control/activator units must be designed using stand-alone hardware and/or mechanical interlocks.
- Do not use PS-G touch panel switches in life-related or important disaster prevention situations. For safety related switches, such as an emergency switch, be sure to use a separate mechanical switch.
- To prevent operator injury or machine damage, be sure to design your machine operation system so that the machine will not malfunction due to a communication fault between the PS-G and its host controller.
- The PS-G is not appropriate for use with aircraft control devices, aerospace equipment, central trunk data transmission (communication) devices, nuclear power control devices, or medical life support equipment, due to these devices inherent requirements of extremely high levels of safety and reliability.
- When using the PS-G with transportation vehicles (trains, cars and ships), disaster and crime prevention devices, various types of safety equipment, non-life support related medical devices, etc. redundant and/or failsafe system designs should be used to ensure the proper degree of reliability and safety.

To prevent this unit from malfunctioning :

- Do not strike the PS-G's touch panel with a hard or heavy object, or press on the touch panel with excessive force, since it may damage the display.
- Do not install the PS-G where the temperature will exceed its specified range.
- Be sure that water, liquids or metal particles do not enter the PS-G, since it may cause a malfunction or a short circuit.
- Avoid installing the PS-G where sudden, large changes in temperature may occur. These changes may cause condensation to form inside the unit, possibly causing a malfunction.
- To prevent excessive heat from building up inside the PS-G, do not install it where its ventilation holes may be blocked. Also, do not install or store the PS-G near high temperature equipment.
- Do not install or store the PS-G in direct sunlight or where high levels of dust exist.
- Since the PS-G is a precision instrument, do not install or store it where either strong shocks or excessive vibration may occur.
- Do not install or store the PS-G in an area containing chemicals or chemical fumes.
- Do not use paint thinner or organic solvents to clean the PS-G's case or screen.
- Due to the danger of unforeseeable accidents, back up all PS-G data regularly.
- After turning this unit OFF, be sure to wait a few seconds before turning it ON again. If the unit is started too soon, it may not start up correctly.

UL/c-UL (CSA) Approval

The PS600G-T41-E124V and PS600G-T41-J124V are UL/c-UL (CSA) listed products. (UL file No.E182139)

This unit conforms as a product to the following standards:

- **UL508**
Industrial Control Equipment
- **UL1604**
Electrical Equipment for use in Class I and II, Division 2 and Class III Hazardous Location, industrial control applications
- **CAN/CSA-C22.2, No.1010-1**
MEASUREMENT AND CONTROL EQUIPMENT
(Safety requirements for electrical equipment for measurement and laboratory use)

PS600G-T41-E124V/PS600G-T41-J124V (UL Registration Model:2880045-22)

<Cautions>

- The PS-G must be used as a built-in component of an end-use product.
- This unit should be installed in the front face of a metal panel.
- If this unit is installed so as to cool itself naturally, be sure to install it in a vertical panel. Also, be sure that the PS-G is mounted at least 100 mm away from any adjacent structures or equipment. If these requirements are not met, the heat generated by the PS-G's internal components may cause the unit to fail to meet UL/c-UL standard requirements.

UL1604 Conditions of Acceptability and Handling Cautions:

1. Power, input and output (I/O) wiring must be in accordance with Class I, Division 2 wiring methods - Article 501- 4(b) of the National Electrical Code, NFPA 70 within the United States, and in accordance with Section 18-152 of the Canadian Electrical Code for units installed within Canada.
2. Suitable for use in Class I, Division 2, Groups A, B, C and D, Hazardous Locations.
3. **WARNING:** Explosion hazard - substitution of components may impair suitability for Class I, Division 2.
4. **WARNING:** Explosion hazard - when in hazardous locations, turn power OFF before replacing or wiring modules.
5. **WARNING:** Explosion hazard - do not disconnect equipment unless power has been switched OFF, or the area is known to be non-hazardous.

CE Marking

The PS600G-T41-E124V and PS600G-T41-J124V are CE marked products that conforms to EMC directives EN55011 class A and EN61000-6-2 (EN50082-2).

Package Contents

The following items are included in the PS-G' package. Before using the PS-G, please confirm that all items listed here are present.

■ PS-G Unit (1)

(PS600G-T41-E124V/
PS600G-T41-J124V)

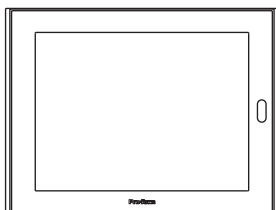

■ Moisture Resistant Gasket (1)



■ Installation Fasteners (4/set)

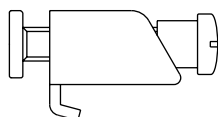

■ Installation Guide (1)

<This Guide>



■ CD-ROM (1)



This unit has been carefully packed, with special attention to quality. However, should you find anything damaged or missing, please contact your local PS-G distributor immediately.

CD-ROM Contents

The CD-ROM contains the following items.

Item	Description
PS-600G Series User Manual	PS-G Unit PDF Manual
Acrobat® Reader 5.0	Software to view PDF Files (Self-Extracting Type)

About The PDF Manual

The CD-ROM contains the following PDF manual file.

- PS-600G Series User Manual (ps600ge.pdf)

Reading a PDF file requires installation of the Adobe Corporation's Acrobat Reader.

■ Acrobat Reader Installation:

To install the Acrobat Reader software, follow the steps given below.

- 1) This software, in the form of a self-extracting file, is located in this CD-ROM in the folder titled [reader]. Use the Explorer software to find the file [ar505enu.exe], and double-click on the file icon to begin the Reader installation.
- 2) After Installation begins, follow the instructions given on the Installation screens.

■ Viewing the PDF manual:

To view the PDF manual contained in this CD-ROM, follow the steps given below.

- 1) Use the Explorer software to locate the file [ps600ge.pdf] in the folder titled [manual].
- 2) Double-click on this file, Acrobat Reader will automatically start and the first page of the PDF manual will appear.

Acrobat® Reader ©Copyright Adobe Systems Incorporated. All rights reserved. Adobe and Acrobat are registered trademarks of Adobe Systems Incorporated. Digital's "Software Usage Conditions" do not apply to Adobe Systems' products.

1 Part Names

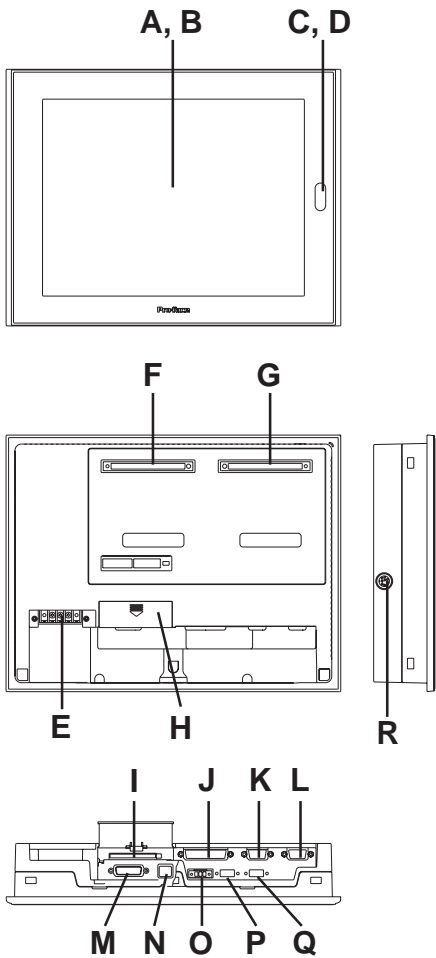

- A : Display
- B : Touch Panel
- C : Status LED
- D : IrDA Interface
- E : Power Input Terminal Block
- F : Expansion Unit Interface 1 (EXT1)
- G : Expansion Unit Interface 2 (EXT2)
- H : CF Card Cover
- I : CF Card Slot
- J : Printer interface (PIO)
- K : Serial Interface (COM 1)
- L : Serial Interface (COM 2)
- M : RAS Interface (RAS)
- N : Ethernet Interface (10BASE-T)
- O : Sound Output Terminal Block
- P : USB interface 1 (USB1)
- Q : USB interface 2 (USB2)
- R : Keyboard / Mouse Interface (KEYBOARD / MOUSE)

2 Dimensions

Unit:mm [in]

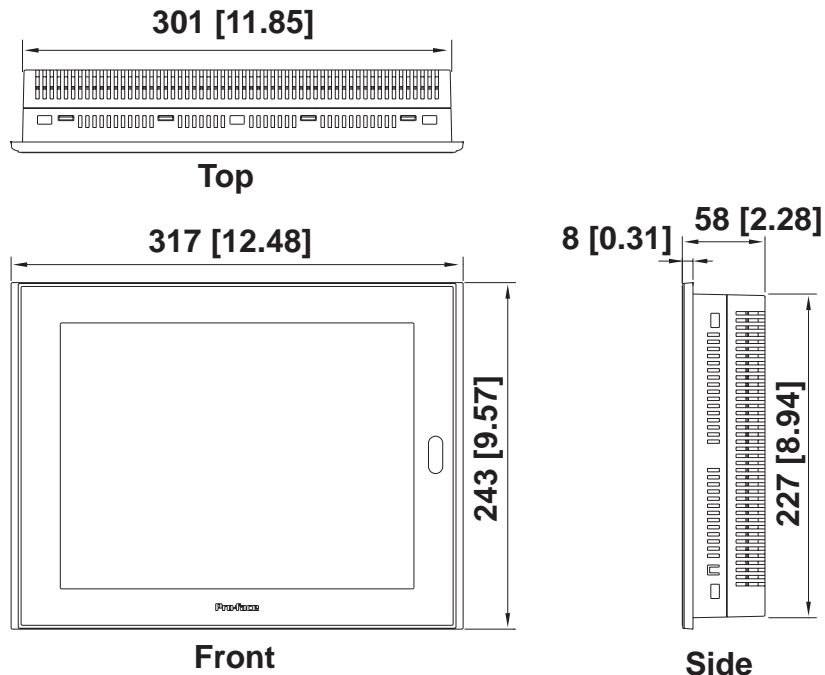

3 General Specifications

■ Electrical

Input Voltage	DC24V
Rated Voltage	DC19.2V to DC28.8V
Allowable Voltage Drop	10 ms or less
Power Consumption	50W or less
In Rush Current	30A or less
Voltage Endurance	AC1000V, 20mA for up to 1 minute (between charging and FG terminals)
Insulation Resistance	10M Ω or more at DC500V (between charging and FG terminals)

■ Environment

Ambient Operating Temperature (Panel interior and Panel face)	0°C to 50°C ^{*1}
Storage Temperature	-20°C to +60°C
Ambient Humidity	10%RH to 90%RH (non-Condensing, dry bulb temperature : 39°C or less)
Dust	0.1mg/m ³ or less (Non-conductive particles)
Atmosphere	Free of corrosive gases
Air-pressure Resistance (Operating altitude)	800 hPa to 1114 hPa (2000 meters or lower)
Vibration Resistance	IEC61131-2 (JIS B 3501) compliant When vibration is NOT continuous 10Hz to 57Hz 0.075 mm, 57Hz to 150Hz 9.8m/s ² When vibration is continuous 10Hz to 57Hz 0.035 mm, 57Hz to 150Hz 4.9m/s ² X,Y,Z directions for 10 times (80min.)
Noise Immunity (via noise simulator)	Noise Voltage: 1200 Vp-p Pulse Duration: 1x10 ⁻⁶ sec. Rise Time: 1ns
Electrostatic Discharge Immunity	Contact Discharge, 6kV (IEC 61000-4-2 Level 3)

*1 If the PS-G's operating temperature exceeds 40 °C for an extended period of time, the display quality, i.e. contrast, etc., may degrade.

■ Structural

Grounding	100Ω or less, or your country's applicable standard
Ratings^{*1}	(Front face of installed unit) Equivalent to IP65f (JEM 1030) Design Type: Modular Installation method: panel mounting
Cooling Method	Natural air circulation
Weight	Approx. 3.5kg (7.7lb)
Dimensions (W·H·D)	317 mm [12.48 in.] x 243 mm [9.57 in.] x 58 mm [2.28 in.]

**1 The front face of the PS-G unit, installed in a solid panel, has been tested using conditions equivalent to the standard shown in the specification. Even though the PS-G unit's level of resistance is equivalent to this standard, oils that should have no effect on the PS-G can possibly harm the unit. This can occur in areas where either vaporized oils are present, or where low viscosity cutting oils are allowed to adhere to the unit for long periods of time. If the PS-G's front face protection sheet becomes peeled off, these conditions can lead to the ingress of oil into the PS-G and separate protection measures are suggested. Also, if non-approved oils are present, it may cause deformation or corrosion of the front panel's plastic cover. Therefore, prior to installing the PS-G be sure to confirm the type of conditions that will be present in the PS-G's operating environment.*

If the installation gasket is used for a long period of time, or if the unit and its gasket are removed from the panel, the original level of the protection cannot be guaranteed. To maintain the original protection level, Pro-face recommends that you replace the installation gasket regularly.

4 Interfaces

■ Serial Interface (COM 1,COM 2)

RS-232C Interface

◆COM1

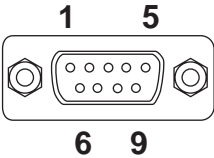
Pin Arrangement	PIN#	Signal	Condition	Direction
	1	CD	Carrier Detect	Input
	2	RD (RXD)	Receive Data	Input
	3	SD (TXD)	Send Data	Output
	4	ER (DTR)	Data Terminal Ready	Output
	5	SG	Signal Ground	-
	6	DR (DSR)	Data Set Ready	Input
	7	RS (RTS)	Request Send	Output
	8	CS (CTS)	Clear Send	Input
	9	CI (RI)	Ringing Indicate	Input

◆COM2

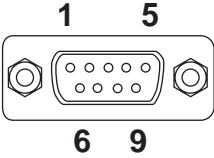
Pin Arrangement	PIN#	Signal	Condition	Direction
	1	NC	No Connection	-
	2	RD (RXD)	Receive Data	Input
	3	SD (TXD)	Send Data	Output
	4	NC	No Connection	-
	5	SG	Signal Ground	-
	6	NC	No Connection	-
	7	RS (RTS)	Request Send	Output
	8	CS (CTS)	Clear Send	Input
	9	VCC	+5V - Power Supply for External Devices	-

Recommended Connector: Dsub 9-pin plug XM2D-0901 <made by OMRON Corp.>

Recommended Cover : Dsub 9-pin Cover XM2S-0913 <made by OMRON Corp.>

Use Jack Screw XM2Z-0073 <made by OMRON Corp.>
when needed.

Recommended Cable : CO-MA-VV-SB5P x 28AWG <made by HITACHI Cable Ltd.>



- The rated electric current of COM2's No.9 (DC5V) output is 0.20A MAX.
- Be sure to connect pin number 5 (SG) of COM1 and COM2 to the host unit's Signal Ground terminal.
- Connect the FG terminal line to the connector shell's PS-G connector fastening screw.
- FG and SG terminals are internally connected in the PS-G. When connecting to another device, be sure to create an SG shorting loop in your system.



Note: Use inch type (#4-40UNC) threads to hold the cable's set (fastening) screws in place.

■ Printer Interface (PIO)

This interface conforms to Centronics standards.

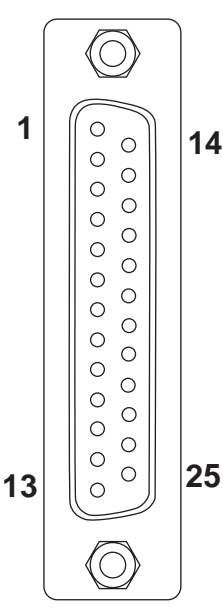
Pin Arrangement	Pin #	Signal	Condition	Direction
	1	$\overline{\text{PSTB}}$	Strobe Signal	Output
	2	PDB0	Data 8 bit	Output
	3	PDB1		Output
	4	PDB2		Output
	5	PDB3		Output
	6	PDB4		Output
	7	PDB5		Output
	8	PDB6		Output
	9	PDB7		Output
	10	$\overline{\text{ACK}}$	Acknowledge	Input
	11	BUSY	Busy Signal	Input
	12	PE	Paper End	Input
	13	SLCT	Select Condition	Input
	14	AF	Auto Feed	Output
	15	$\overline{\text{ERROR}}$	Printer Error	Input
	16	$\overline{\text{INIT}}$	Initialize Signal	Output
	17	$\overline{\text{SLCTIN}}$	Select In	Output
	18	GND	Ground	-
	19	GND	Ground	-
	20	GND	Ground	-
	21	GND	Ground	-
	22	GND	Ground	-
	23	GND	Ground	-
	24	GND	Ground	-
	25	GND	Ground	-

Recommended Connector : Dsub 25-pin plug XM2A-2501 <made by OMRON Corp.>
 Recommended Cover : Dsub 25-pin Cover XM2S-2513 <made by OMRON Corp.>
 Use Jack Screw XM2Z-0073 <made by OMRON Corp.> when needed.

■ Sound Output Terminal Block

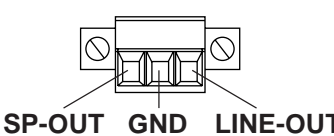
Pin Arrangement	Signal	Condition	Direction
	SP-OUT	Speaker Output Terminal	Output
	GND	Ground	-
	LINE-OUT	Line Out Output Terminal	Output

■ Keyboard / Mouse Interface

PS/2 compatible Keyboard / Mouse Interface

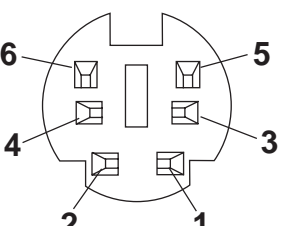
Pin Arrangement	Pin #	Signal	Condition
	1	KEYDATA	KeyData (Interactive)
	2	MOUSE DATA	Mouse Data (Interactive)
	3	GND	Ground
	4	+5V	External Power Supply
	5	KEYCLK	KeyClock (Interactive)
	6	MOUSE CLK	Mouse Clock (Interactive)

■ RAS Interface (RAS)

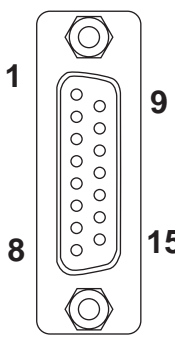
Pin Arrangement	Pin #	Signal	Condition
	1	ALARM-OUT (-)	Alarm Output (-)
	2	DOUT (-)	General Purpose Output (-)
	3	RESET-IN (-)	Remote Reset Input (-)
	4	DIN0 (-)	General Purpose Input 0 (-)* ¹
	5	DIN1 (-)	General Purpose Input 1 (-)* ¹
	6	NC	No Contact
	7	RESERVE	Reserved
	8	RESERVE	Reserved
	9	ALARM-OUT (+)	Alarm Output (+)
	10	DOUT (+)	General Purpose Output (+)
	11	RESET-IN (+)	Remote Reset Input (+)
	12	DIN0 (+)	General Purpose Input 0 (+)* ¹
	13	DIN1 (+)	General Purpose Input 1 (+)* ¹
	14	RESERVE	Reserved
	15	RESERVE	Reserved

*1 General Purpose Input will latch Input Information. (This detects only the DIN circuit's ON state. OFF is not monitored.)

Recommended Connector : Dsub 15-pin plug XM2A-1501 <made by OMRON Corp.>

Recommended Cover : Dsub 15-pin Cover XM2S-1513 <made by OMRON Corp.>

Use Jack Screw XM2Z-0073 <made by OMRON Corp.>
when needed.

■ Ethernet Interface (10BASE-T)

This interface complies with the IEEE802.3 Ethernet communication standard (10BASE-T). This interface uses an RJ-45 type modular jack connector (8 points).

■ CF Card Slot

This slot accepts a CF Card.

■ USB Interface (USB1, USB2)

This interface is for connecting USB equipment.

■ Expansion Unit Interface 1 (EXT1)

This interface is used to connect a DIO unit.

■ Expansion Unit Interface 2 (EXT2)

This interface is a PCMCIA Bus interface.

This is used to connect a PCMCIA unit.

5 Installation

■ Confirm the Installation Gasket's Positioning

It is strongly recommended that you use the installation gasket.

Place the PS-G on a level surface with the display panel facing downward.

Check that the PS-G's installation gasket is seated securely into the gasket's groove, which runs around the perimeter of the panel's frame.



- Before installing the PS-G into a cabinet or panel, check that the installation gasket is securely attached to the unit.
- A gasket which has been used for a long period of time may have scratches or dirt on it, and could have lost much of its dust and drip resistance. Be sure to change the gasket periodically (or when scratches or dirt become visible).
- Be sure to use gasket model GP570-WP10-MS.
- Be sure the gasket's seam is not inserted into any of the unit's corners, only in the straight sections of the groove. Inserting it into a corner may lead to its eventually tearing.

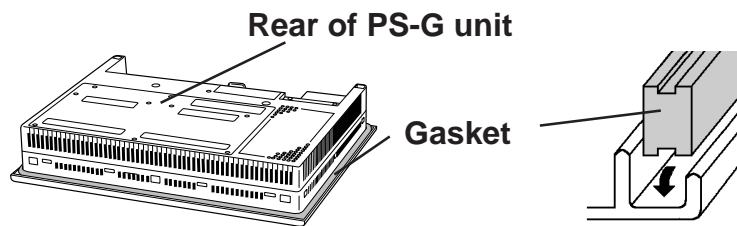

■ Create a Panel Cut

Insert the PS-G into the panel from the front

Unit: mm [in.]

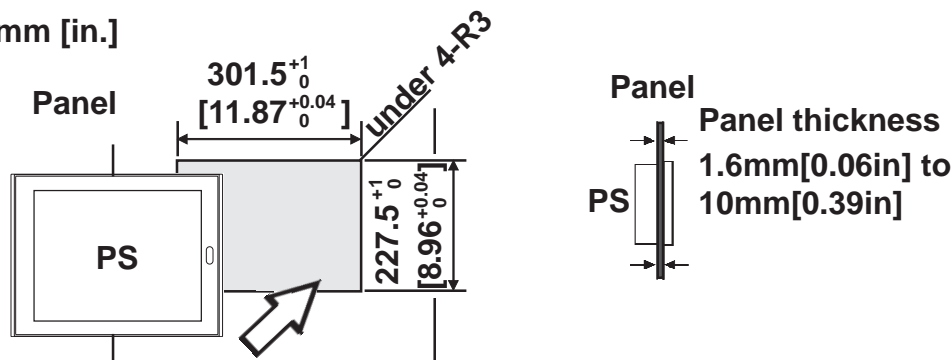

■ Attach the Installation Fasteners from Inside the Panel

The following figures show the four (4) insertion slot locations of the PS-G installation fasteners. Insert the hook section into the slot and tighten the fastener with a screwdriver, as shown.

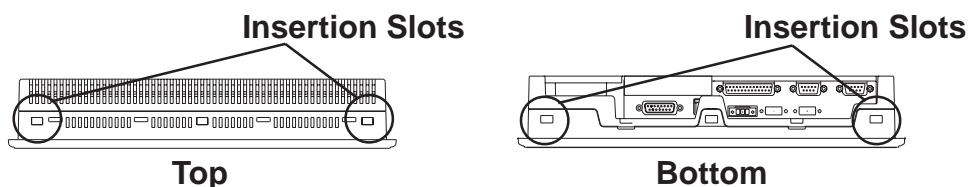

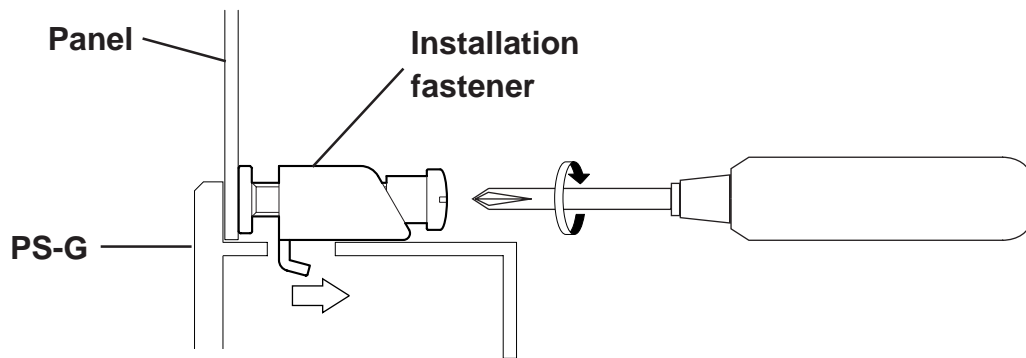

- Do not tighten the screws with too much force, since it can damage the PS-G unit's plastic case.
- The torque necessary to create a drip-resistant seal is 0.5 N•m.



- Depending on the installation panel's thickness, etc., the number of installation fasteners used may need to be increased to provide the desired level of moisture resistance.
- Installation fasteners are sold by your local PS-G distributor.
- Be sure to use installation fastener model GP070-AT01.

■ Installation Requirements

To enhance the PS-G's maintainability, operability and ventilation, allow at least 100 mm clearance between the PS-G and other objects. (The clearance must be large enough to allow you to install or uninstall option units and to attach connectors.)

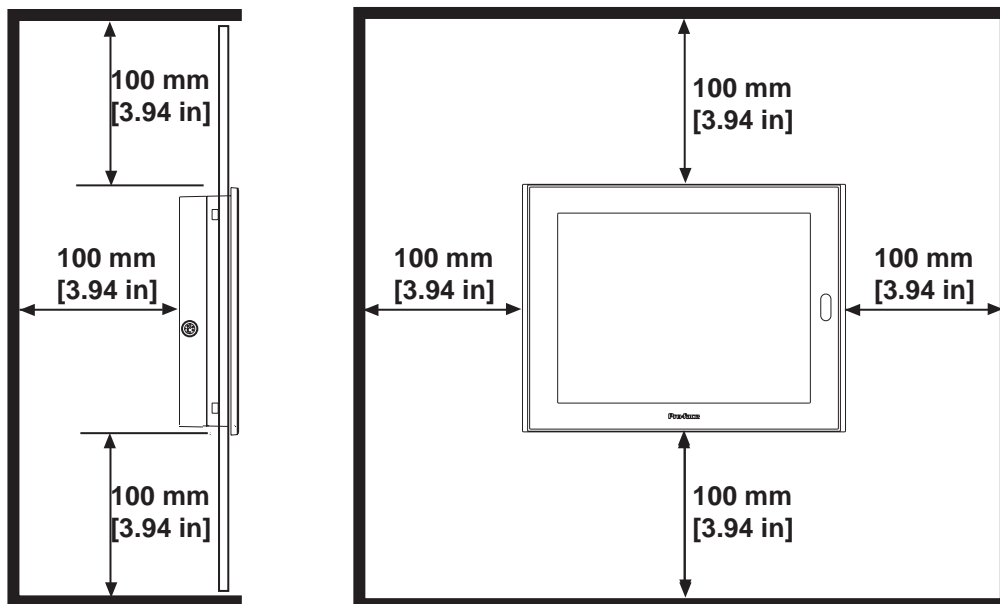

6 Wiring

WARNINGS

- To avoid an electric shock, check that the PS-G's power supply is completely turned OFF, via a breaker, or similar unit before connecting the PS-G's power cord terminals to the power terminal block.
- The PS600G-T41-E124V and PS600G-T41-J124V can accept only DC24V input. If you use power other than DC24V, you can damage both the power supply and the PS-G unit.
- Since the PS-G unit has no power ON/OFF switch, be sure to attach a breaker type switch to its power cord.



When the FG terminal is connected, be sure the wire is grounded. Not grounding the PS-G unit will result in excess noise and vibration.



- Wherever possible, use thick wires (max. 2 mm²) for PS-G power cord power terminals. Also, to reduce noise be sure to twist the wire ends before attaching the connectors.
- Use the following sized Ring Terminals.

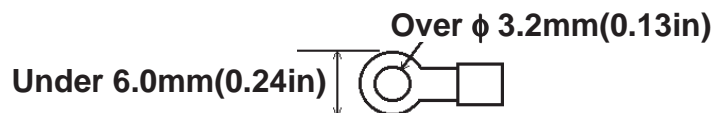

- To avoid a short caused by loose ring terminals, be sure to use ring terminals with an insulating sleeve.

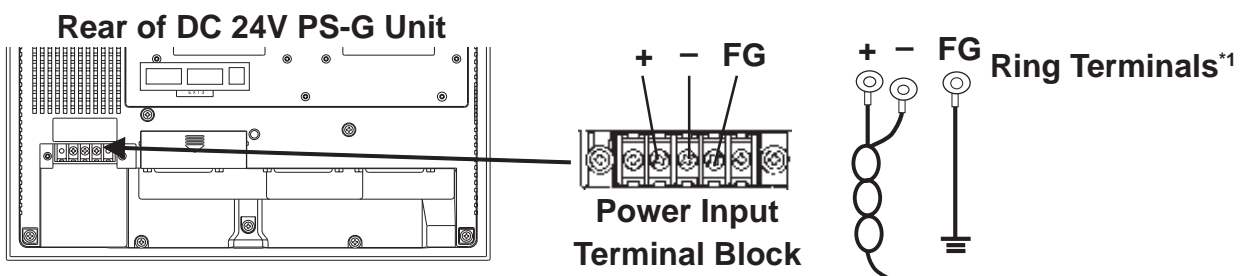

*1 + : Live line

- : GND line

FG : Ground Terminal connected to the PS-G chassis

Suggested Ring Terminal : V2-MS3 (made by JST)

■ Connecting the PS-G's Power Cord Terminals

When connecting the power cord, be sure to follow the procedures given below.

1. Confirm that the PS-G's power cord is unplugged from the power supply.
2. Use a screwdriver to remove the Power Input Terminal Block's clear plastic cover.
3. Remove the screws from the middle three (3) terminals, align the Ring Terminals and re-attach the screws.
4. Confirm that the wires are connected correctly.
5. Replace the Power Input Terminal Block's clear plastic cover.



The torque required to tighten these screws is 0.5 to 0.6N•m.

7 Power Supply Cautions

Please pay special attention to the following instructions when connecting the power cord terminals to the PS-G unit.

- If the power supply voltage exceeds the PS-G unit's range, connect a voltage transformer.
- Between the line and the ground, be sure to use a low noise power supply. If there is still an excessive amount of noise, connect a noise reducing transformer.
- Input and Output signal lines must be separated from the power control cables for operational circuits.
- To increase the noise resistance, be sure to twist the ends of the power cord before connecting it to the PS-G unit.
- The PS-G unit's power supply cord should not be bundled with or kept close to main circuit lines (high voltage, high current), or input/output signal lines.
- Connect a surge absorber to handle power surges.
- To reduce noise, make the power cord as short as possible.

8 Grounding Cautions

- When attaching a wire to the PS-G's rear face FG terminal, (on the Power Input Terminal Block), be sure to create an exclusive ground.*1
- FG and SG terminals are internally connected in the PS-G. When connecting to another device, be sure to create an SG shorting loop in your system.

*1 Use a grounding resistance of 100Ω, a wire of 2mm² or thicker, or your country's applicable standard.

9 Input/Output Signal Line Cautions

- Input and Output signal lines must be separated from the power control cables for operational circuits.
- If this is not possible, use a shielded cable and the shield should be grounded.

10 Replacing the Backlight

- The PS-G unit's backlight is user replaceable.
For an explanation of how to replace the PS-G unit's backlight, please refer to the instruction manual which comes with the replacement backlights (sold separately).
- Be sure to use backlight model PS600-BU00.



Using any backlight other than the model written above may cause an accident or PS-G unit malfunction.

Note

Be aware that the Digital Electronics Corporation shall not be held liable for any real or estimated damages or losses, or third party claims resulting from the use of this product.

Memo