

MMCloud TCP Client Driver

1	System Configuration.....	3
2	External Device Selection	4
3	Communication Settings	5
4	Setup Items	8
5	Supported Device Addresses.....	12
6	Device Code and Address Code.....	19
7	Error Messages.....	20

Introduction

This manual describes how to connect the Display and the External Device (target cloud services).

In this manual, the connection procedure will be described by following the below sections:

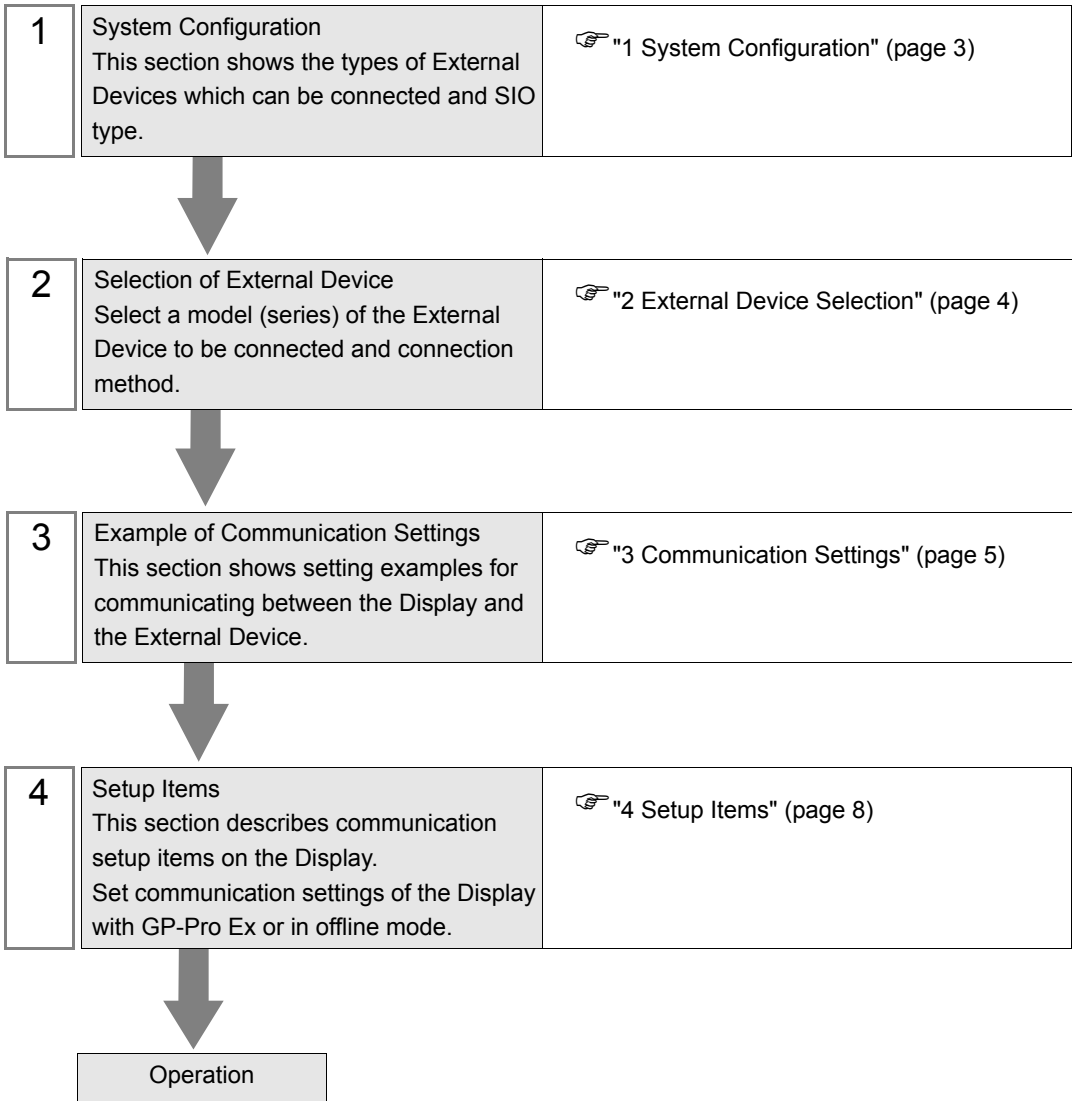

1 System Configuration

The system configuration for connecting Yaskawa Information Systems Corporation's MMLink with the Display is shown below.

Service	CPU	Link I/F	SIO Type	Setting Example
MMCloud Series	-	MMLink-3G	Ethernet (TCP)	Setting Example 1 (page 5)

- NOTE** • This driver sends sampled data collected on the Display to cloud services. You cannot get data from the cloud service.

■ Connection Configuration

- NOTE** • This manual explains the MMLink connection. Please refer to the MMCloud manual for the MMLink and MMCloud settings related to mobile communication.

- 1:1 Connection

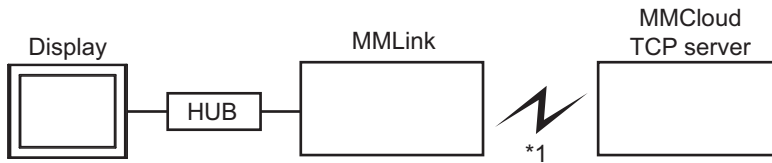

- n:1 Connection

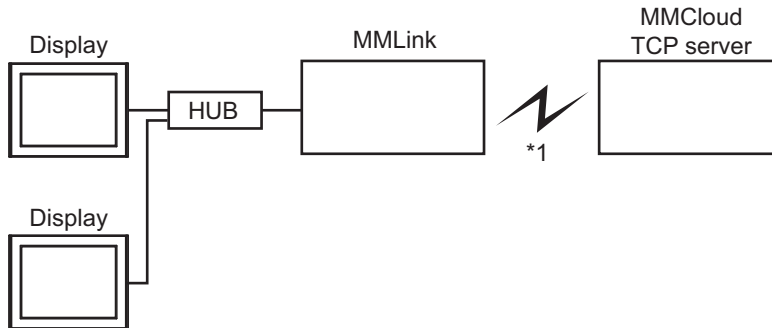

- *1 Mobile communication

2 External Device Selection

Select the External Device to be connected to the Display.

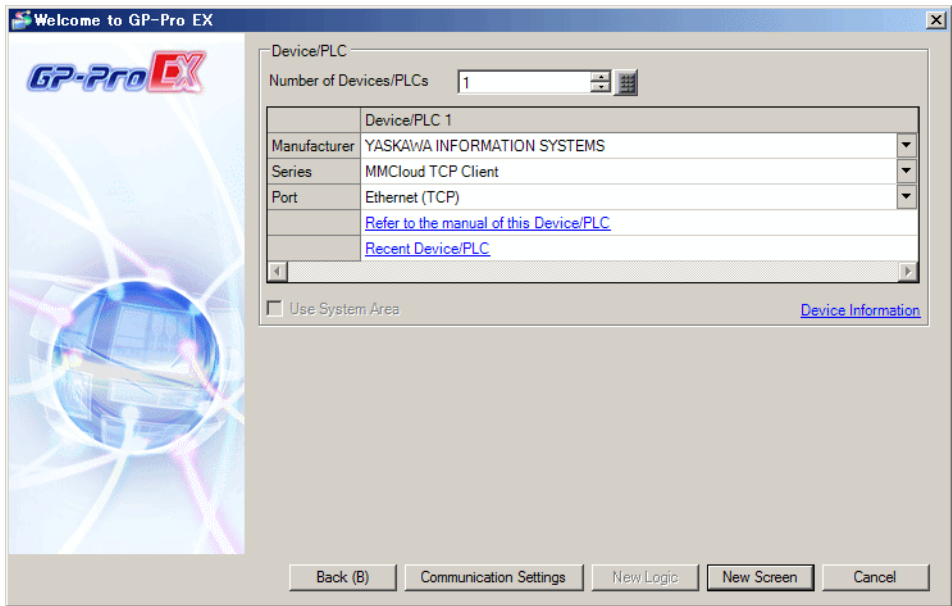

Setup Items	Setup Description
Number of Devices/PLCs	Enter an integer from 1 to 4 for the number of series to set.
Manufacturer	Select the manufacturer of the External Device to be connected. Select "YASKAWA INFORMATION SYSTEMS".
Series	Select a model (series) of the External Device to be connected and connection method. Select "MMCloud TCP Client". Check the External Device which can be connected in "MMCloud TCP Client" in system configuration. ☞ "1 System Configuration" (page 3)
Port	Select the Display port to be connected to the External Device.
Use System Area	This driver cannot be used.

3 Communication Settings

Examples of communication settings of the Display and the External Device, recommended by Pro-face, are shown.

3.1 Setting Example 1

■ GP-Pro EX Settings

◆ Communication Settings

To display the setup screen, from the [Project] menu, point to [System Settings] and select [Device/PLC].

Device/PLC 1

Summary [Change Device/PLC](#)

Manufacturer Series Port

Text Data Mode [Change](#)

Communication Settings

Port No. Auto

Timeout (sec)

Retry

Device-Specific Settings

Allowable Number of Devices/PLCs 16 [Add Device](#)

No.	Device Name	Settings	Add Indirect Device
1	PLC1	Protocol Version=1,Communication Profile=Communica	<input type="button" value="Add Indirect Device"/>

◆ Device Settings

To display the [Individual Device Settings] dialog box, from [Device Specific Settings] in the [Device/PLC] window, select the External Device and click [Settings] . To connect multiple External Devices, from [Device Specific Settings] in the [Device/PLC] window, click [Add Device] to add another External Device.

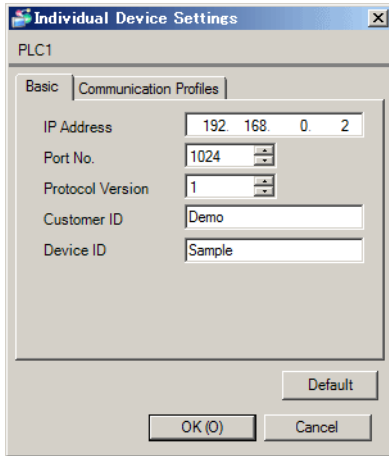

Individual Device Settings

PLC1

Basic | Communication Profiles

IP Address: 192 168 0 2

Port No.: 1024

Protocol Version: 1

Customer ID: Demo

Device ID: Sample

Default

OK (O) Cancel

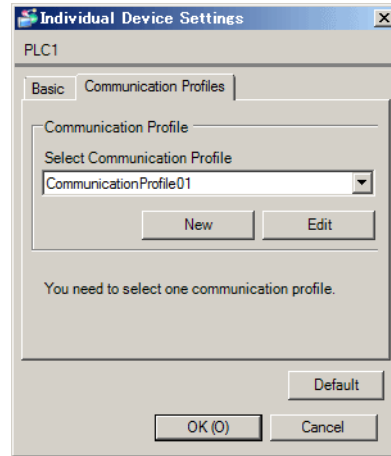

Individual Device Settings

PLC1

Basic | Communication Profiles

Communication Profile

Select Communication Profile

CommunicationProfile01

New Edit

You need to select one communication profile.

Default

OK (O) Cancel

◆ Notes

- To use this driver, you need to create tag data.
- ☞ " ■ Making a New Communication Profile" (page 14)
- Enter the IP address, port number and customer ID as notified by the MMCloud contract.
- Check with a network administrator about IP address. Do not set the duplicate IP address.
- The IP address on the Display needs to be set up in the Display's offline mode.

■ External Device Settings

The connection (LAN) between MMLink and the Display is described below.

Please refer to the MMLink manual for details of LAN and MMLink connection (WAN) to cloud services.

- 1 Set the MMLink dip switch to maintenance mode.

Dip Switch	Setting	Dip Switch	Setting
1	ON	4	OFF
2	OFF	5	OFF
3	ON	6	OFF

- 2 Connect the MMLink LAN port and computer with a LAN cable.
- 3 Turn ON the MMLink.
- 4 Using a Web browser, access <http://192.168.0.133>.
- 5 Enter the user name and password set up on the MMLink.
- 6 Set system parameters.

Setup Items	Setting
IP Address	192.168.0.133
Sub Net Mask	255.255.255.0
Default Gateway	192.168.0.1
Service Port number for local	777
Port number for Web setting	80
Destination IP Address	192.168.0.3 ^{*1}

*1 Set the IP address of the Display.

- 7 Click [Setting] and write the defined settings to the MMLink.
- 8 Turn OFF the MMLink. Set all dip switch to OFF and return to router mode.
- 9 Turn ON the MMLink.

◆ Notes

- Check with a network administrator about IP address. Do not set the duplicate IP address.
- The IP address on the Display needs to be set up in the Display's offline mode.

4 Setup Items

Set communication settings of the Display with GP-Pro EX or in offline mode of the Display.

The setting of each parameter must be identical to that of External Device.

☞ "3 Communication Settings" (page 5)

NOTE • Set the Display's IP address in offline mode.

Cf. Maintenance/Troubleshooting Guide "Ethernet Settings"

4.1 Setup Items in GP-Pro EX

■ Communication Settings

To display the setup screen, from the [Project] menu, point to [System Settings] and select [Device/PLC].

Device/PLC 1

Summary [Change Device/PLC](#)

Manufacturer Series Port

Text Data Mode [Change](#)

Communication Settings

Port No. Auto

Timeout (sec)

Retry

Device-Specific Settings

Allowable Number of Devices/PLCs [Add Device](#)

No.	Device Name	Settings	Add Indirect Device
<input type="text" value="1"/>	<input type="text" value="PLC1"/>	<input type="text" value="Protocol Version=1,Communication Profile=Communica"/>	<input type="button" value="Add Indirect Device"/>

Setup Items	Setup Description
Port No.	Use an integer from 1024 to 65535 to enter port number. If a check is put in [Auto], port number is set automatically.
Timeout	Use an integer from 1 to 127 to enter the time (s) for which the Display waits for the response from the External Device.
Retry	In case of no response from the External Device, use an integer from 0 to 255 to enter how many times the Display retransmits the command.

NOTE • Refer to the GP-Pro EX Reference Manual for Indirect Device.

Cf. GP-Pro EX Reference Manual "Changing the Device/PLC at Runtime (Indirect Device)"

■ Device Setting

To display the [Individual Device Settings] dialog box, from [Device Specific Settings] in the [Device/PLC] window, select the External Device and click [Settings] . To connect multiple External Devices, from [Device Specific Settings] in the [Device/PLC] window, click [Add Device] to add another External Device.

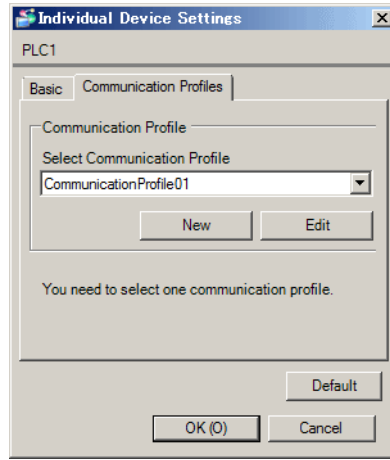
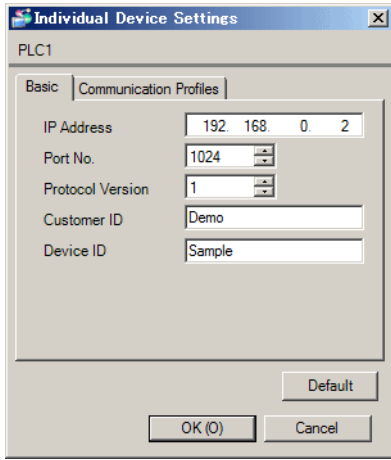

Setup Items	Setup Description
IP Address	Set the IP address of server. Enter the IP address as notified by the MMCloud contract. NOTE • Check with a network administrator about IP address. Do not set the duplicate IP address.
Port No.	Enter the port number for server, with an integer from 1 to 65535. Enter the port number as notified by the MMCloud contract.
Protocol Version	Enter the External Device protocol version from 0x01 to 0x02.
Customer ID	Enter the customer ID as notified by the MMCloud contract.
Device ID	Enter the device ID set in MMCloud.
Communication Profiles	Select the External Device Communication Profile. To make a new Communication Profile, click [New].  " ■ Making a New Communication Profile" (page 14) To edit the selected Communication Profile, click [Edit].

4.2 Setup Items in Offline Mode

NOTE • Refer to the Maintenance/Troubleshooting guide for information on how to enter offline mode or about the operation.

Cf. Maintenance/Troubleshooting Guide "Offline Mode"

■ Communication Settings

To display the setting screen, touch [Device/PLC Settings] from [Peripheral Settings] in offline mode. Touch the External Device you want to set from the displayed list.

Comm.	Device			
MMCloud TCP Client		[TCP]	Page 1/1	
Port No.	<input type="radio"/> Fixed <input checked="" type="radio"/> Auto	<input type="text" value="1024"/> ▼ ▲		
Timeout(s)		<input type="text" value="10"/> ▼ ▲		
Retry		<input type="text" value="0"/> ▼ ▲		
	Exit	Back	2017/06/14 11:02:24	

Setup Items	Setup Description
Port No.	Set the port No. of the Display. Select either [Fixed] or [Auto]. When you select [Fixed], use an integer from 1024 to 65535 to enter the port No. of the Display. When you select [Auto], the port No. will be automatically assigned regardless of the entered value.
Timeout (s)	Use an integer from 1 to 127 to enter the time (s) for which the Display waits for the response from the External Device.
Retry	In case of no response from the External Device, use an integer from 0 to 255 to enter how many times the Display retransmits the command.

■ Device Setting

To display the setting screen, touch [Device/PLC Settings] from [Peripheral Settings]. Touch the External Device you want to set from the displayed list, and touch [Device].

Comm.	Device			
MMCloud TCP Client		[TCP]	Page 1/1	
Device/PLC Name <input type="text" value="PLC1"/>				
IP Address		<input type="text" value="192 168 0 2"/>		
Port No.		<input type="text" value="1024"/> ▼ ▲		
Protocol Version		<input type="text" value="1"/> ▼ ▲		
Exit		Back		2017/06/14 11:02:28

Setup Items	Setup Description
Device/PLC Name	Select the External Device device to set up. Device/PLC Name is the label applied to the External Device in GP-Pro EX. (Initial value is [PLC1])
IP Address	Set IP address of the server. Enter the IP address as notified by the MMCloud contract. NOTE • Check with a network administrator about IP address. Do not set the duplicate IP address.
Port No.	Enter the port number of the server with an integer from 1 to 65535. Enter the port number as notified by the MMCloud contract.
Protocol Version	Enter the protocol version of the External Device with an integer from 0x01 to 0x02.

5 Supported Device Addresses

Range of supported device address is shown in the table below. Please note that the actually supported range of the devices varies depending on the External Device to be used. Please check the actual range in the manual of your External Device.

Device	Bit Address	Word Address	32 bit	Remarks
BOOL	<TAGNAME>		-	*1 *2
INT	-	<TAGNAME>	<u>H/L</u>	*1 *2
REAL	-	<TAGNAME>	-	*1 *2
WORD	-	<TAGNAME>	<u>H/L</u>	*1 *2
UINT	-	<TAGNAME>	<u>H/L</u>	*1 *2
STRING	-	<TAGNAME>	-	*1 *2
DATE_AND_TIME*3	-	<TAGNAME>	-	*1

*1 You cannot use the following character strings as the first characters of a tag name.
LS, USR, SCR, PRT

*2 Table showing relationship of data types between the External Device and Display

External Device		Display	Remarks
Data Type	Data Length	Data Type	
BIT	1	BOOL	*1
INT	1	INT	*1
INT	2	INT	*1
INT	4	INT	*1
REAL NO.	4	REAL	*1
REAL NO.	8	-	*1 *2
WORD	1	WORD	*1
WORD	2	WORD	*1
UNSIGNEDINT	1	UINT	*1
UNSIGNEDINT	2	UINT	*1
UNSIGNEDINT	4	UINT	*1
TEXT	1 to 512 characters	STRING	*1

*1 Enter the data length when creating communication profiles.

*2 The Display does not support 64-bit data types.

- *3 Use DATE_AND_TIME to transfer to MCloud the date and time collected by the sampling function. The only supported date and time format is "yyMMddhhmmssSSS" (year, month, day, hours, minutes, seconds, milliseconds). To transfer the date and time to MCloud, you need to register a data point to MCloud. As the date and time is transferred in sequential order beginning with the first item (yy), register items in the same order and with the same data length as the date format.

Example date and time Data Point settings

Setup Items	Setting Value 1	Setting Value 2	Setting Value 3	Setting Value 4	Setting Value 5	Setting Value 6	Setting Value 7
Code	d1	d2	d3	d4	d5	d6	d7
Data Type	INT	INT	INT	INT	INT	INT	INT
Start Byte (Length)	1(1)	2(1)	3(1)	4(1)	5(1)	6(1)	7(2)
Receipt format	yy	MM	dd	hh	mm	ss	SSS

NOTE • Please refer to the precautions on manual notation for icons in the table.

 "Manual Symbols and Terminology"

Communication Profile Setting Example

MMCloud Settings

Communication Command

Setup Items	Setting Value
Command code	0x1003
Command name	Sample

NOTE • When communicating with a display unit, define the communication settings as follows:

Setup Items	Setting Value
Protocol	TCP
Record Format	FIX
Encoding Type	UTF-8

Data Point

Setup Items	Setting Value 1	Setting Value 2
Data Point Code	dpc1	dpc2
Data Type	Integer	Integer
Start Byte (Length)	1(2)	3(2)

GP-Pro EX Settings

Enter the settings in accordance with the MCloud settings.

Data Point

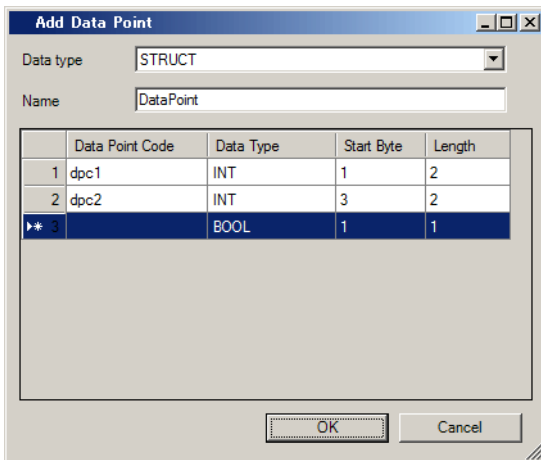

Communication Command

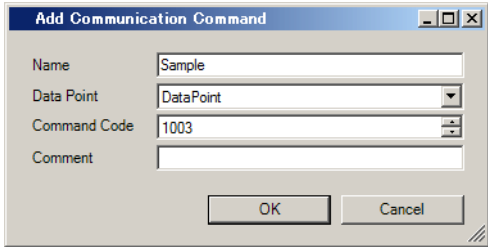

The image shows a dialog box titled "Add Communication Command". It contains four input fields: "Name" with the value "Sample", "Data Point" with a dropdown menu showing "DataPoint", "Command Code" with a dropdown menu showing "1003", and "Comment" which is empty. At the bottom right, there are "OK" and "Cancel" buttons.

Name	Sample
Data Point	DataPoint
Command Code	1003
Comment	

6 Device Code and Address Code

Device code and address code cannot be used.

7 Error Messages

Error messages are displayed on the Display screen as follows: "No.: Device Name: Error Message (Error Occurrence Area)". Each description is shown below.

Item	Description
No.	Error No.
Device Name	Name of the External Device where error occurs. Device name is a title of the External Device set with GP-Pro EX. (Initial value [PLC1])
Error Message	Displays messages related to the error which occurs.
Error Occurrence Area	<p>Displays IP address or device address of the External Device where error occurs, or error codes received from the External Device.</p> <p>NOTE</p> <ul style="list-style-type: none"> • IP address is displayed such as "IP address (Decimal): MAC address (Hex)". • Device address is displayed such as "Address: Device address". • Received error codes are displayed such as "Decimal [Hex]".

Display Examples of Error Messages

"RHAA035: PLC1: Error has been responded for device write command (Error Code: 2 [02H])"

-
- NOTE**
- Refer to your External Device manual for details on received error codes.
 - Refer to "Display-related errors" in "Maintenance/Troubleshooting Guide" for details on the error messages common to the driver.
-

■ Error codes stored in the Global Trigger Status

Error code (DEC)	Description	Details
15	Invalid device error	Invalid or undefined device address for the destination address.
16	Communication error	Error occurred during communication.
17	Sampling data error	Unable to load the sampled data properly.
18	Send size error	Unable to send a portion of the data.

- NOTE**
- Unable to load sampled data stored without the date and time of samples. When this happens, error code 17 is stored in the Global Trigger Status field. In the Sampling Group's [Mode] tab, click [Extended] and confirm the [Add Time Data] check box is selected.
 - Each sampling group has an upper limit on the size of sampled data that you can transfer at one time. When you are unable to transfer all the sampled data, error code 18 is stored in the Global Trigger Status field. To transfer all sampled data, satisfy the Global Trigger condition again or adjust the address size sampled in one sampling group so it does not exceed 63 KB (number of addresses x 2 bytes x number of occurrences sampled).
 - Set up your Global Trigger conditions to avoid transferring multiple sampling groups at the same time.