



TOYOPUC CMP-LINK Ethernet Driver

1	System Configuration.....	3
2	Selection of External Device	6
3	Example of Communication Setting.....	7
4	Setup Items	40
5	Supported Device.....	44
6	Device Code and Address Code.....	50
7	Error Messages.....	54

Introduction

This manual describes how to connect the Display and the External Device (target PLC).

In this manual, the connection procedure will be described by following the below sections:

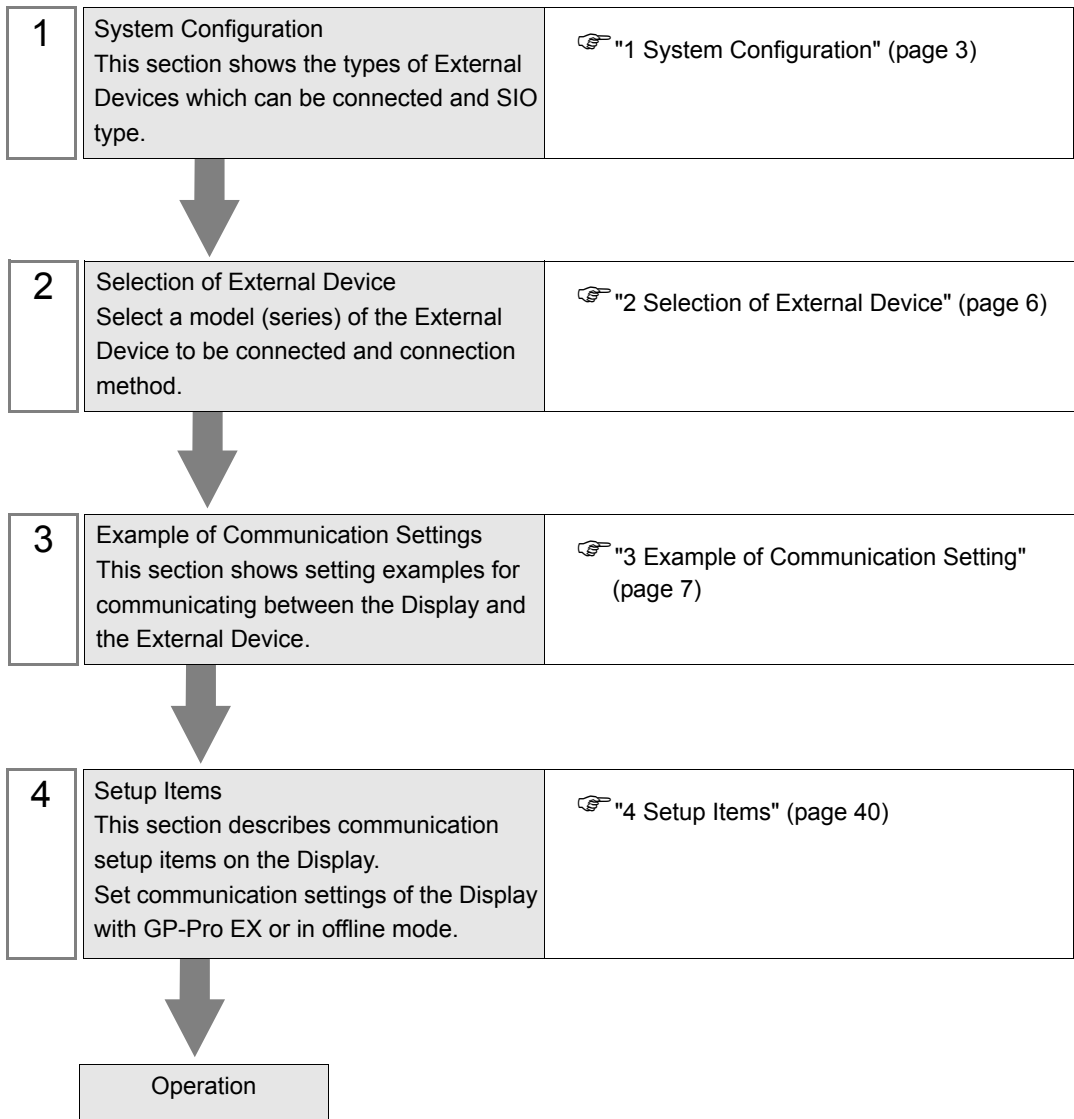

1 System Configuration

The system configuration in the case when the External Device of JTEKT Corporation and the Display are connected is shown.

Series	CPU	Link I/F	SIO Type	Protocol Open Method	Setting Example
TOYOPUC-PC3	PC3 PC3J PC3JD PC3JG	Ethernet port of THU-5296*1	Ethernet (UDP)	UDP	Setting Example 1 (page 7)
			Ethernet (TCP)	Target unspecified passive	Setting Example 2 (page 10)
				Target specified passive	Setting Example 3 (page 13)
		Ethernet port of THU-5781*1	Ethernet (UDP)	UDP	Setting Example 4 (page 16)
			Ethernet (TCP)	Target unspecified passive	Setting Example 5 (page 22)
				Target specified passive	Setting Example 6 (page 28)
TOYOPUC-PC10G	PC10G	L1 Port on CPU Unit L2 Port on CPU Unit	Ethernet (UDP)	UDP	Setting Example 7 (page 34)
			Ethernet (TCP)	Target unspecified passive	Setting Example 8 (page 36)
				Target specified passive	Setting Example 9 (page 38)

*1 In TCP connection, you can connect max 8 units of the Display to 1 External Device.

■ Connection Configuration

- 1:1 Connection

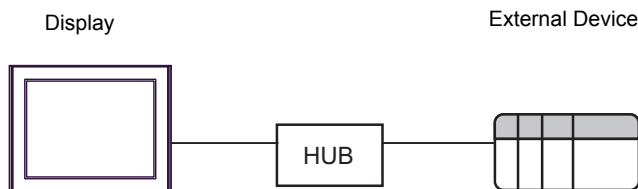

- 1:n Connection

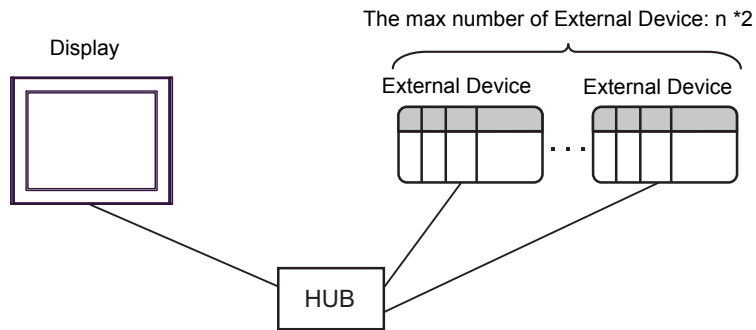

- n:1 Connection

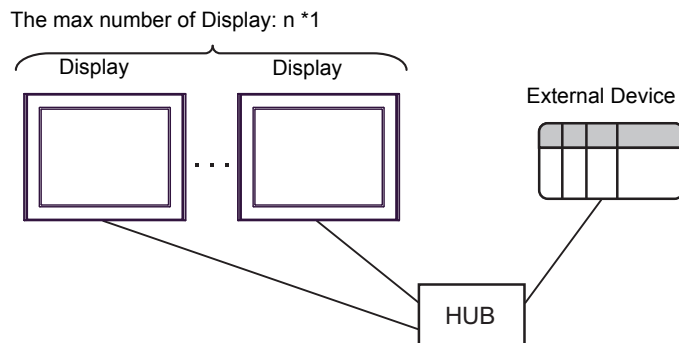

- n:m Connection

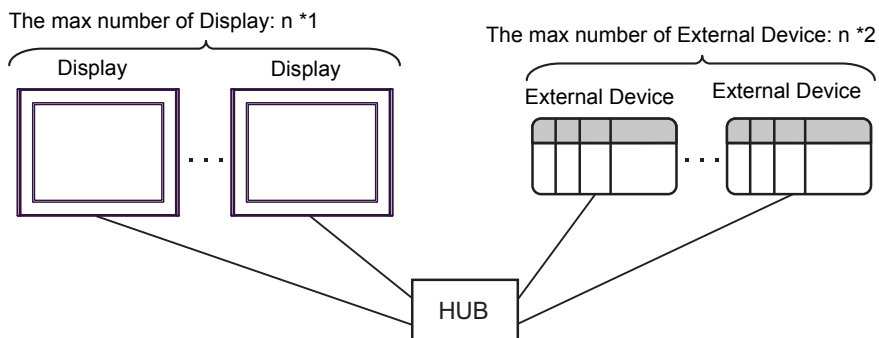

- *1 The maximum number of Displays varies depending on the External Device series and the settings.
- When TOYOPUC-PC3 is used, up to 8 Displays can be connected.
 - When "Ethernet" is specified for L1/L2 port settings on the CPU unit in TOYOPUC-PC10G, up to 8 Displays can be connected.
 - When "Ethernet (32 ports)" is specified for L1/L2 port settings on the CPU unit in TOYOPUC-PC10G, up to 32 Displays can be connected.
"Ethernet (32 ports)" can be specified only when the CPU version is V.3.00 or later.
- *2 For UDP and TCP connections, up to 32 and 16 External Devices can be connected respectively.

- FL-NET Connection

You can use this driver to access up to 4 layers of External Device connected to FL-NET.

In the [Individual Device Settings] dialog box, in hierarchical order, set up the program number / link number of External Device that act as relays, and the destination External Device's node number.

Example [Individual Device Settings] with the following network structure.

Set up each connected piece of External Device (such as A1 and X1 shown in the figure) using the ladder software PCwin. Display the [Link parameter setup] dialog box and set up the program number / link number and node number of the port to connect to FL-NET.

- Network Structure

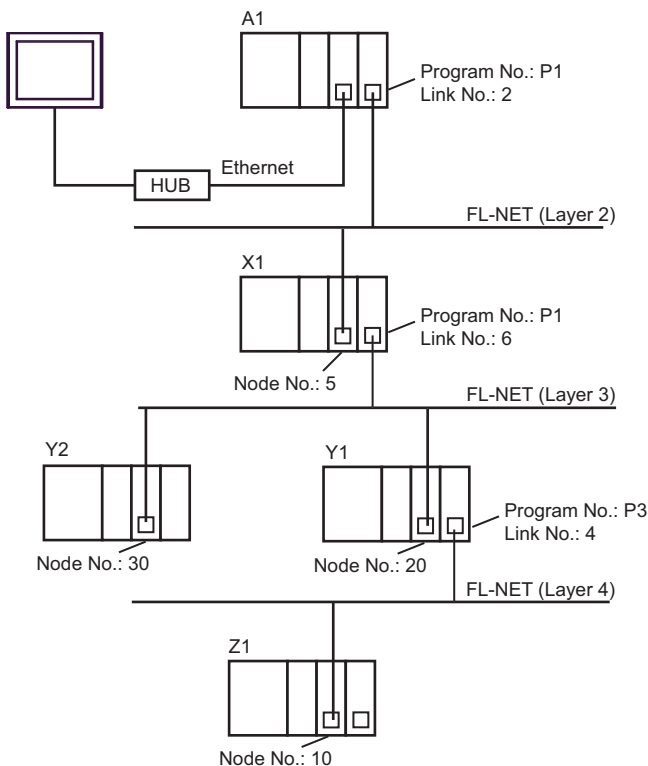

- Contents of [Individual Device Settings]

External Device to access	No. of Layers	Layer	Program No.	Link No.	Relay / Destination (Node No.)
X1	2	2	1	2	5
Y2	3	2	1	2	5
		3	1	6	30
Z1	4	2	1	2	5
		3	1	6	20
		4	3	4	10

2 Selection of External Device

Select the External Device to be connected to the Display.

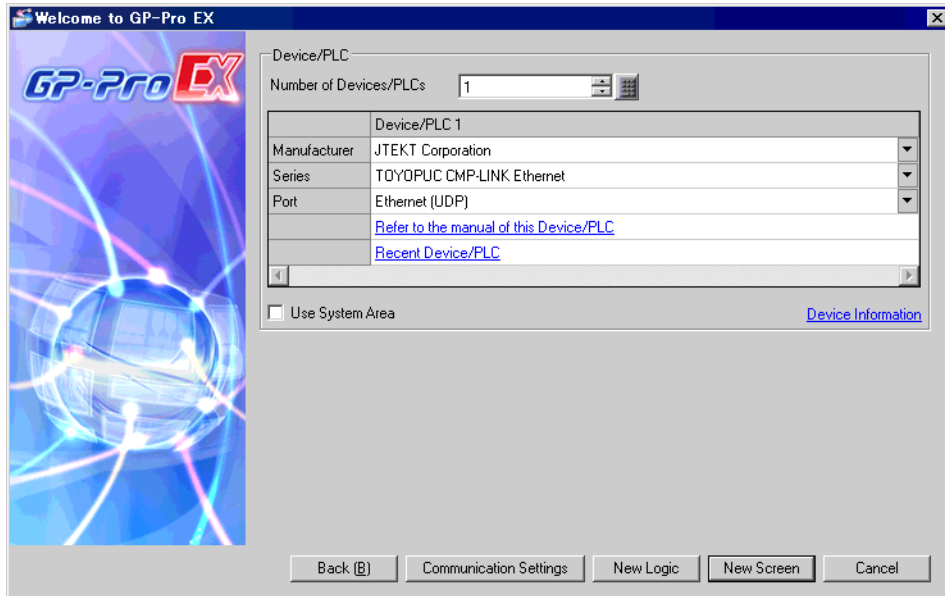

Setup Items	Setup Description
Number of Devices/PLCs	Use an integer from 1 to 4 to enter the number of Devices/PLCs to connect to the display.
Manufacturer	Select the manufacturer of the External Device to be connected. Select "JTEKT Corporation".
Series	Select a model (series) of the External Device to be connected and connection method. Select "TOYOPUC CMP-LINK Ethernet". Check the External Device which can be connected in "TOYOPUC CMP-LINK Ethernet" in system configuration. ☞ "1 System Configuration" (page 3)
Port	Select the Display port to be connected to the External Device.
Use System Area	Check this option to synchronize the system data area of the Display and the device (memory) of the External Device. When synchronized, you can use the External Device's ladder program to switch the display or display the window on the Display. Cf. GP-Pro EX Reference Manual "LS Area (Direct Access Method Area)" This feature can also be set in GP-Pro EX or in the Display's offline mode. Cf. GP-Pro EX Reference Manual "System Settings [Display Unit] - [System Area] Settings Guide" Cf. Maintenance/Troubleshooting Guide "Main Unit - System Area Settings"

3 Example of Communication Setting

Examples of communication settings of the Display and the External Device, recommended by Pro-face, are shown.

When you use the TOYOPUC-PC3 Series, use GP-Pro EX and the ladder software to set as below.

3.1 Setting Example 1

■ Settings of GP-Pro EX

◆ Communication Settings

To display the setup screen, from the [Project] menu, point to [System Settings] and select [Device/PLC].

◆ Device Setting

To display the [Individual Device Settings] dialog box, from [Device-Specific Settings] in the [Device/PLC] window, select the External Device and click [Settings] . To connect multiple External Devices, from [Device-Specific Settings] in the [Device/PLC] window, click [Add Device] to add another External Device.

◆ Notes

- Check with a network administrator about IP address. Do not set the duplicate IP address.
- Set IP address on the External Device for IP address in Device-specific settings.
- You need to set IP address on the Display in the offline mode of the Display.

■ Setting of External Device

Use the rotary switch on the front of the unit to set the mode switch. Use the ladder software to set other switches than the mode switch. Please refer to Sample of Ladder Program for the sample ladder to write the initial data.

Setup Items		Setup Description
Mode Switch		0
Active Open		0: Not request
PING Request		1: Request
Source Node IP Address		192.168.0.1
Source Node Port No.		401 (HEX)
Use Other Node Table		Use
Connection	Protocol Open Method	0001H
	Other Node Table No.	Preset other node table No.
Other Node Table	CPU Operation Mode	PC3
	Other Node IP Address	Set IP address of the Display.
	Other Node Port No.	Set the port No. of the Display.

◆ Example of Ladder Program

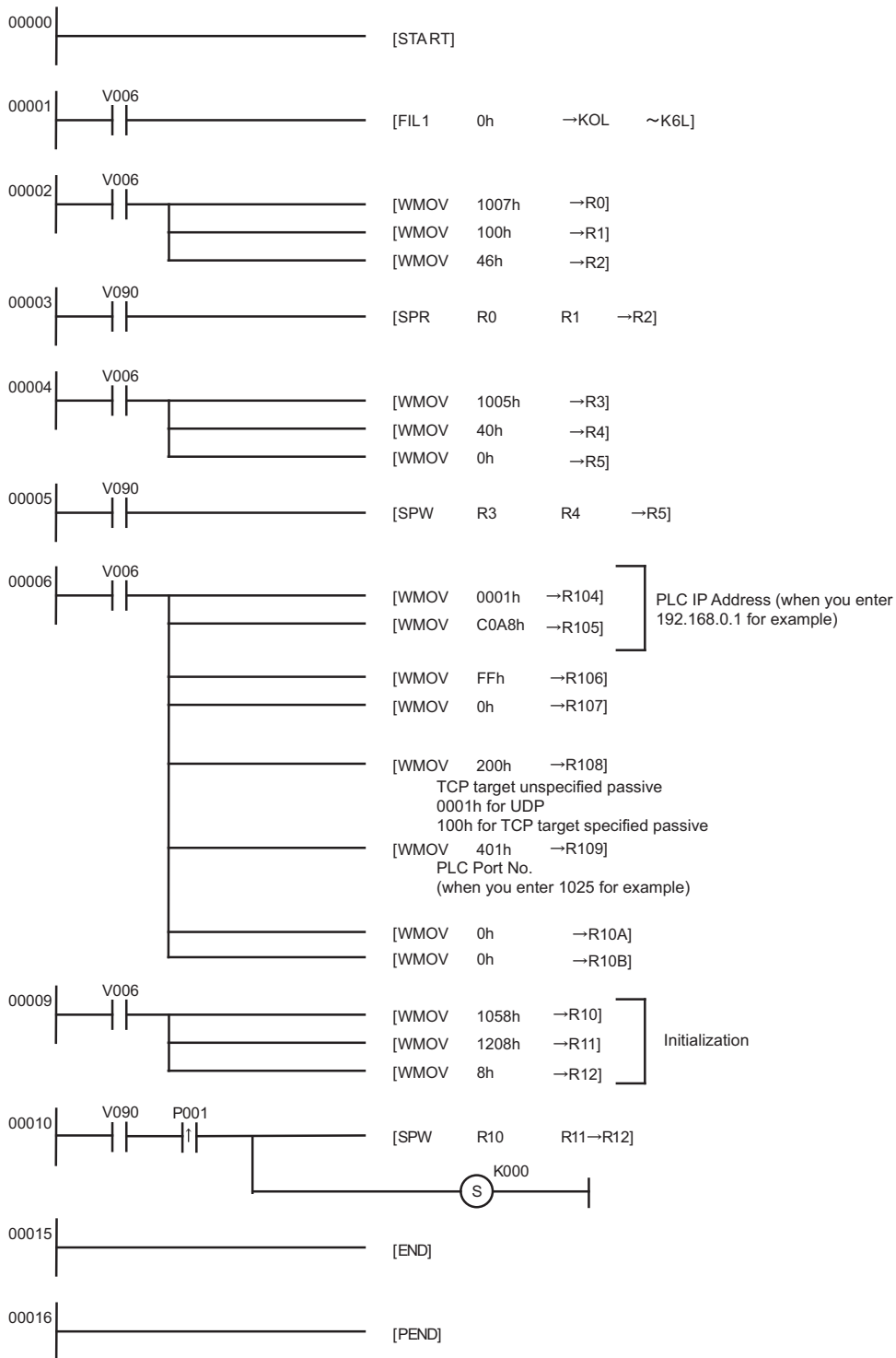

◆ Notes

- Check with a network administrator about IP address. Do not set the duplicate IP address.
- Please refer to the manual of the External Device for more details.

3.2 Setting Example 2

■ Settings of GP-Pro EX

◆ Communication Settings

To display the setup screen, from the [Project] menu, point to [System Settings] and select [Device/PLC].

◆ Device Setting

To display the [Individual Device Settings] dialog box, from [Device-Specific Settings] in the [Device/PLC] window, select the External Device and click [Settings]. To connect multiple External Devices, from [Device-Specific Settings] in the [Device/PLC] window, click [Add Device] to add another External Device.

◆ Notes

- Check with a network administrator about IP address. Do not set the duplicate IP address.
- Set IP address on the External Device for IP address in Device-specific settings.
- You need to set IP address on the Display in the offline mode of the Display.

■ Setting of External Device

Use the rotary switch on the front of the unit to set the mode switch. Use the ladder software to set other switches than the mode switch. Please refer to Sample of Ladder Program for the sample ladder to write the initial data.

Setup Items		Setup Description
Mode Switch		0
Active Open		0: Not request
PING Request		1: Request
Source Node IP Address		192.168.0.1
Source Node Port No.		401 (HEX)
Use Other Node Table		Not use
Connection	Protocol Open Method	0200H
	Other Node Table No.	Setting unnecessary

◆ Example of Ladder Program

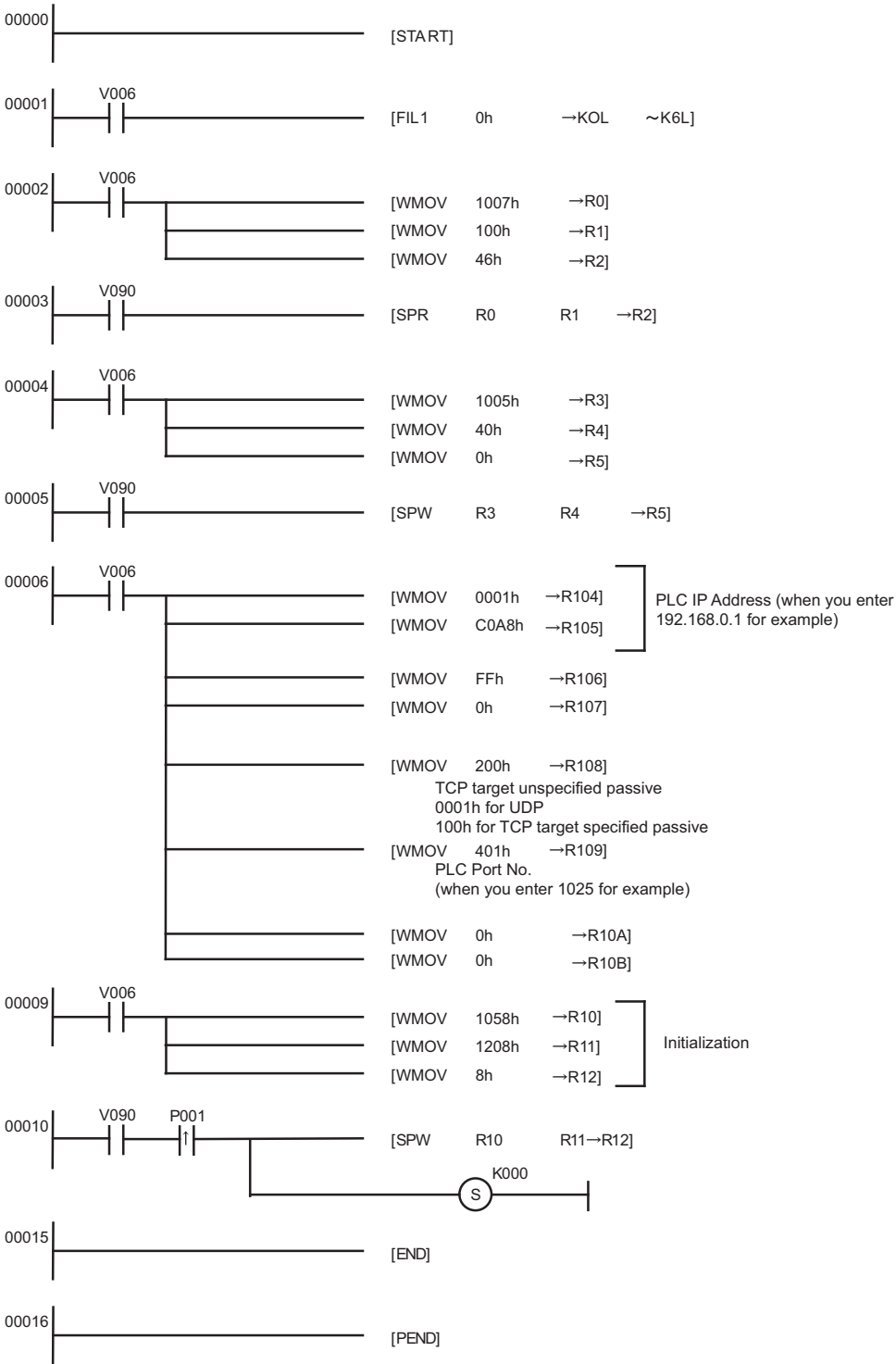

◆ Notes

- Check with a network administrator about IP address. Do not set the duplicate IP address.
- Please refer to the manual of the External Device for more details.

3.3 Setting Example 3

■ Settings of GP-Pro EX

◆ Communication Settings

To display the setup screen, from the [Project] menu, point to [System Settings] and select [Device/PLC].

◆ Device Setting

To display the [Individual Device Settings] dialog box, from [Device-Specific Settings] in the [Device/PLC] window, select the External Device and click [Settings]. To connect multiple External Devices, from [Device-Specific Settings] in the [Device/PLC] window, click [Add Device] to add another External Device.

◆ Notes

- Check with a network administrator about IP address. Do not set the duplicate IP address.
- Set IP address on the External Device for IP address in Device-specific settings.
- You need to set IP address on the Display in the offline mode of the Display.

■ Setting of External Device

Use the rotary switch on the front of the unit to set the mode switch. Use the ladder software to set other switches than the mode switch. Please refer to Sample of Ladder Program for the sample ladder to write the initial data.

Setup Items		Setup Description
Mode Switch		0
Active Open		0: Not request
PING Request		1: Request
Source Node IP Address		192.168.0.1
Source Node Port No.		401 (HEX)
Use Other Node Table		Use
Connection	Protocol Open Method	0100H
	Other Node Table No.	Preset other node table No.
Other Node Table	CPU Operation Mode	PC3
	Other Node IP Address	Set IP address of the Display.
	Other Node Port No.	Set the port No. of the Display.

◆ Example of Ladder Program

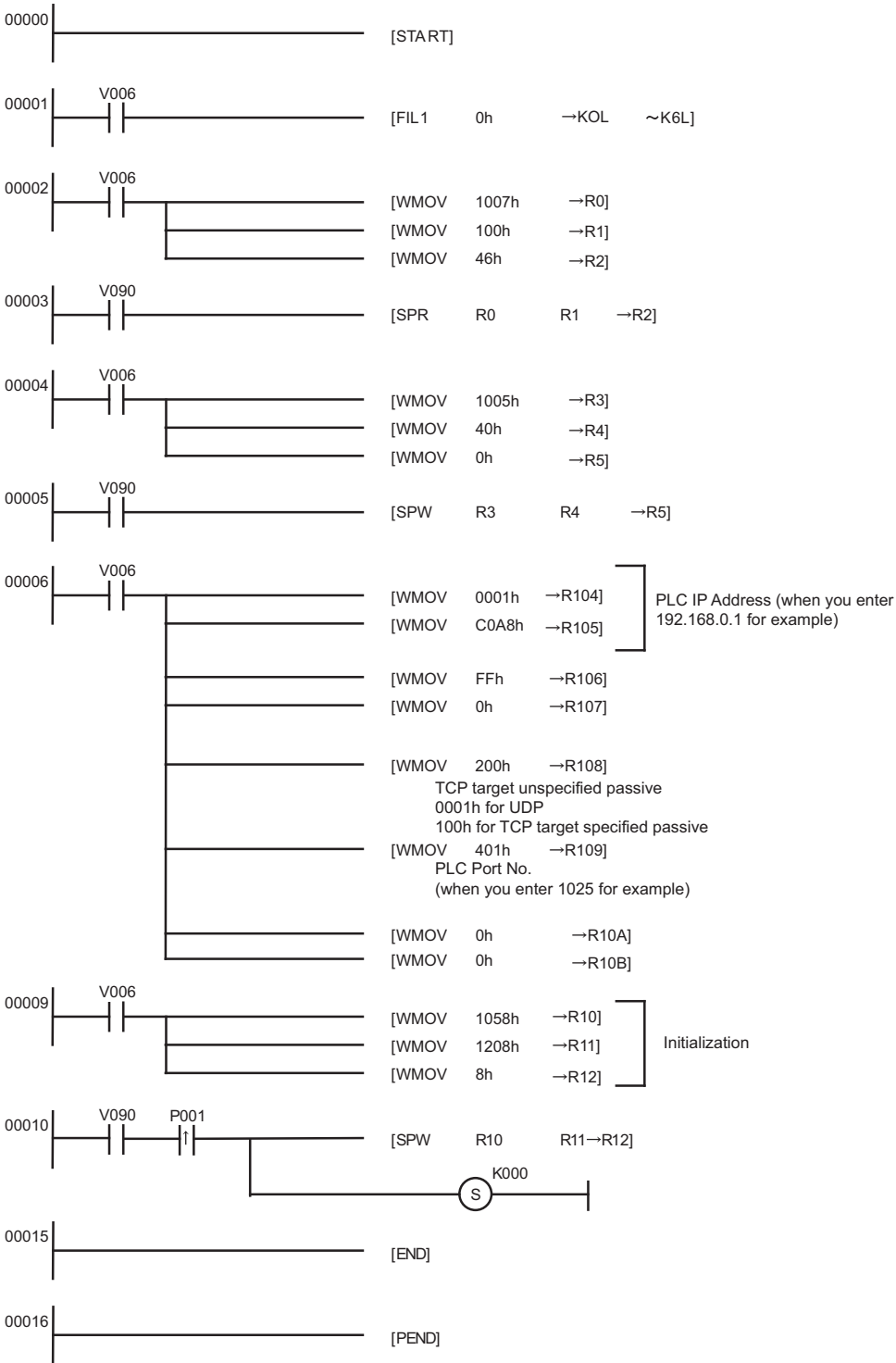

◆ Notes

- Check with a network administrator about IP address. Do not set the duplicate IP address.
- Please refer to the manual of the External Device for more details.

3.4 Setting Example 4

■ Settings of GP-Pro EX

◆ Communication Settings

To display the setup screen, from the [Project] menu, point to [System Settings] and select [Device/PLC].

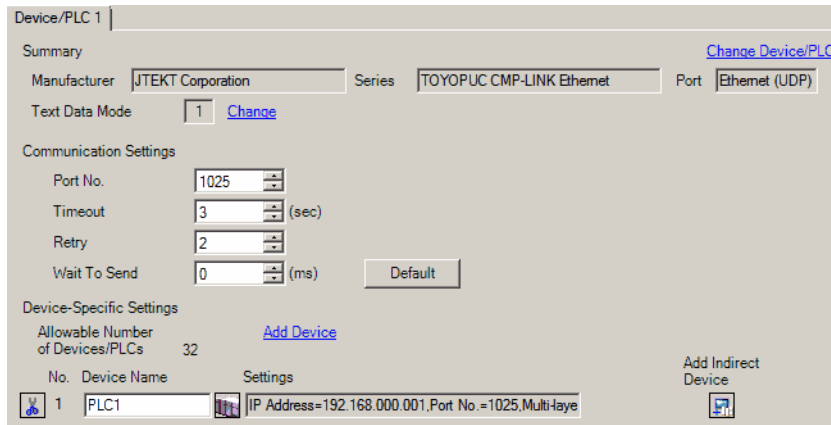

◆ Device Setting

To display the [Individual Device Settings] dialog box, from [Device-Specific Settings] in the [Device/PLC] window, select the External Device and click [Settings]. To connect multiple External Devices, from [Device-Specific Settings] in the [Device/PLC] window, click [Add Device] to add another External Device.

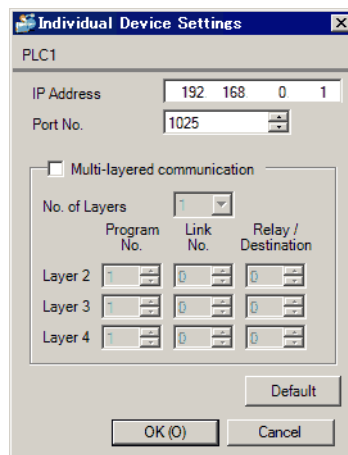

◆ Notes

- Check with a network administrator about IP address. Do not set the duplicate IP address.
- Set IP address on the External Device for IP address in Device-specific settings.
- You need to set IP address on the Display in the offline mode of the Display.

■ Setting of External Device

Use the programming software PCwin to set as below.

◆ Settings of I/O Module

Open [I/O Module Settings] of [Parameter] in the peripheral equipment and set the I/O Module identification code.

Setup Items	Setup Description
Slot No.	0
Assignment Item Number	00
Identification Code	B3
Module Type	Special/Communication
Module Name	Time Chart Module/Computer Link/Ethernet/S-NET

◆ Settings of Link Module

Open the link setting for [Link Parameter] of [Parameter] in the peripheral equipment. Select the Rack No. and Slot No. to which Ethernet module is assigned, and set the link module name to [Ethernet]. If you also use the PC3J Series CPU program divide mode, please select the correct program number.

Setup Items	Setup Description
Rack No.	Option
Slot No.	Option
Link Module Name	Ethernet

◆ Settings of Communication Parameter

Set as below in the communication parameter.

Setup Items	Setup Description	
Source Node IP Address	192.168.0.1	
Connection	Protocol Open Method	UDP
	Source Node Port No.	1025
	Other Node Table No.	Preset other node table No.
Other Node Table	CPU Operation Mode	PC3
	Other Node IP Address	Set IP address of the Display.
	Other Node Port No.	Set the port No. of the Display.

Communication parameter settings include the following two methods.

A. Setting method in the link parameter setting screen of the peripheral equipment.

To use this setting method, the programming software PCwin is necessary. You cannot use other software or tools to set the communication parameter with link parameters.

- 1 Select [Detail Settings] of [Link Parameter] from [Parameter] in the peripheral equipment to display [Communication Parameter Setting Screen].
- 2 Display the [Ethernet Setting] screen to set each parameter.

Setup Items	Setup Description
Source Node IP Address	192.168.0.1
Connection	Option (1 - 8)
Protocol Open Method	UDP
Source Node Port No.	1025
Other Node Table No.	Preset other node table No.
Initialization	Initialize by link parameters

- 3 Select [Other Node Table Setting] in the [Ethernet Setting] screen to set other node tables.

Setup Items	Setup Description
Table	Option (1 - 16)
Other Node IP Address	Set IP address of the Display.
Other Node Port No.	Set the port No. of the Display.

B.) Setting method by the ladder program

Use the ladder program as below to set the communication parameter.

- 1 Set the communication parameter in the register data.
- 2 Use the SPW command of function instruction to transfer the communication parameter to the file memory in the Ethernet module.
- 3 Use the SPW command of function instruction to set the initial request bit of the file memory in the Ethernet module to ON.

Example of communication parameter is shown below.

Source Node IP Address = 192.168.0.1 (C0.A8.00.01h)

Use Connection No.1, 2, 3 and Other Node Table No.1, 2

Connection 1: TCP active, Port No.6000 (1770h), Other Node Table No.1

Connection 2: TCP target specified passive, Port No.6001 (1771h), Other Node Table No.2

Connection 3: TCP target unspecified passive, Port No.6002 (1772h)

Other Node Table 1: IP Address = 192.168.0.2 (C0.A8.00.02h), Port No. 8000 (1F40h)

Other Node Table 2: IP Address = 192.168.0.3 (C0.A8.00.03h), Port No. 8001 (1F41h)

Register Data	Setting Data	Data Description
R0104	0001	Source Node IP Address (Low)
R0105	C0A8	Source Node IP Address (High)
R0106	0307	Table (1, 2) used/Connection (1, 2, 3) used
R0107	0000	Connection (9 - 16) used
R0108	0000	Connection 1: TCP active
R0109	1770	Connection 1: Port No.
R010A	0001	Connection 1: Other Node Table No.
R010B	0000	0000 Fixed
R010C	0100	Connection 2: TCP target specified passive
R010D	1771	Connection 2: Port No.
R010E	0002	Connection 2: Other Node Table No.
R010F	0000	0000 Fixed
R0110	0200	Connection 3: TCP target unspecified passive
R0111	1772	Connection 3: Port No.
R0112	0000	Connection 3: Other Node Table No.
R0113	0000	0000 Fixed
R0114- R0127	0000	No setting for Connection 4 - 8 (not used)
R0128	0002	Other Node Table 1: Other Node IP Address (Low)
R0129	C0A8	Other Node Table 1: Other Node IP Address (High)
R012A	1F40	Other Node Table 1: Other Node Port No.
R012B	0000	0000 Fixed
R012C	0003	Other Node Table 2: Other Node IP Address (Low)
R012D	C0A8	Other Node Table 2: Other Node IP Address (High)
R012E	1F41	Other Node Table 2: Other Node Port No.
R012F	0000	0000 Fixed

◆ Example of Ladder Program

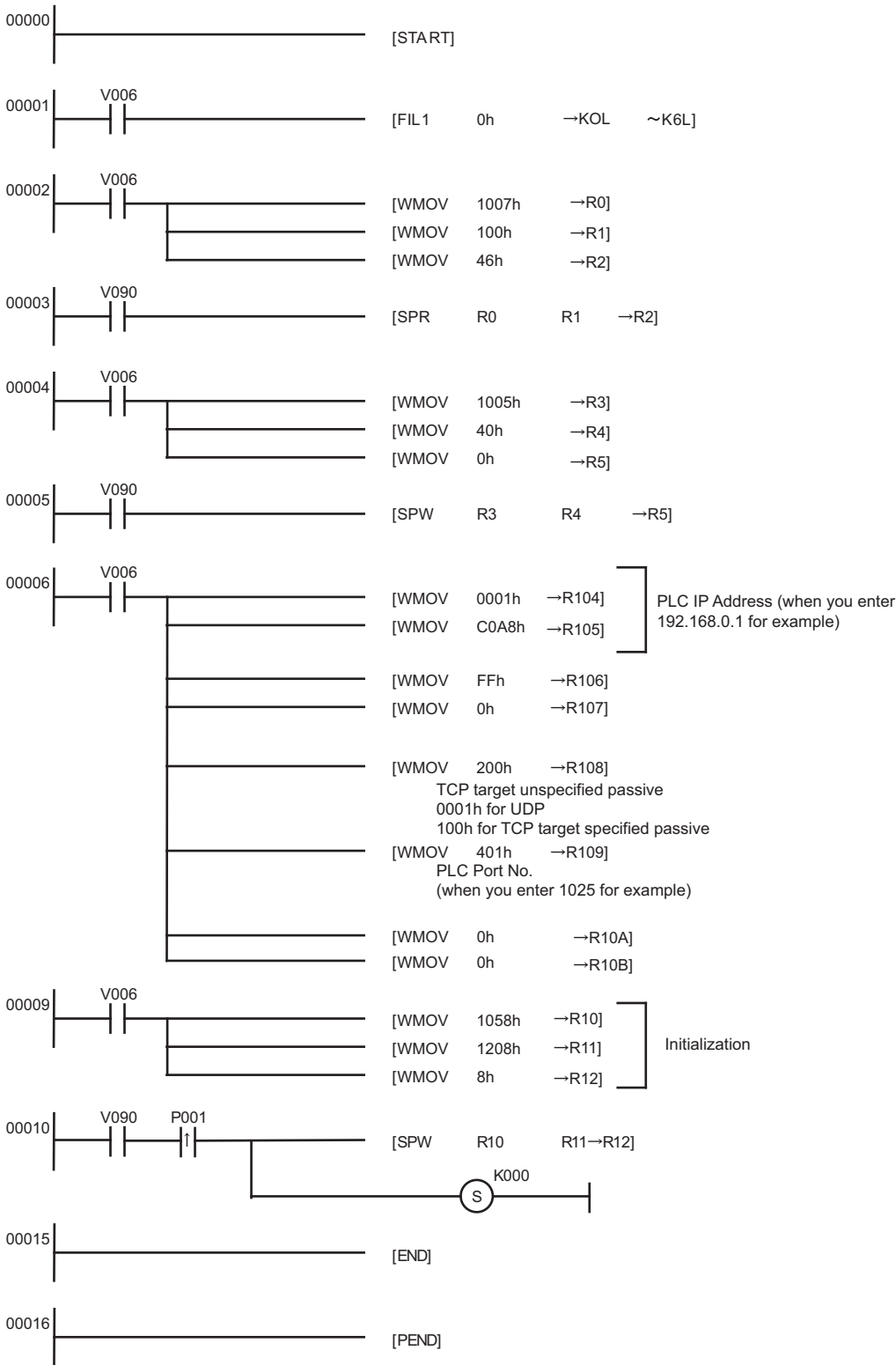

- NOTE** • When the communication parameter is set by both the link parameter and the ladder program, the setting by the link parameter normally is given priority. However, when you select [Initialize by Initial Sequence Program] in the link parameter setting screen, the setting by the ladder program becomes effective even if the link parameter is set.
-

◆ Notes

- Check with a network administrator about IP address. Do not set the duplicate IP address.
- Please refer to the manual of the External Device for more details.

3.5 Setting Example 5

■ Settings of GP-Pro EX

◆ Communication Settings

To display the setup screen, from the [Project] menu, point to [System Settings] and select [Device/PLC].

Device/PLC 1

Summary [Change Device/PLC](#)

Manufacturer Series Port

Text Data Mode [Change](#)

Communication Settings

Port No. Auto

Timeout (sec)

Retry

Wait To Send (ms)

Device-Specific Settings

Allowable Number of Devices/PLCs [Add Device](#)

No.	Device Name	Settings
<input type="button" value="1"/>	<input type="text" value="PLC1"/>	<input type="button" value="IP Address=192.168.000.001,Port No.=1025,Multi-laye"/>

◆ Device Setting

To display the [Individual Device Settings] dialog box, from [Device-Specific Settings] in the [Device/PLC] window, select the External Device and click [Settings] . To connect multiple External Devices, from [Device-Specific Settings] in the [Device/PLC] window, click [Add Device] to add another External Device.

Individual Device Settings

PLC1

IP Address

Port No.

Multi-layered communication

No. of Layers

	Program No.	Link No.	Relay / Destination
Layer 2	<input type="text" value="1"/>	<input type="text" value="0"/>	<input type="text" value="0"/>
Layer 3	<input type="text" value="1"/>	<input type="text" value="0"/>	<input type="text" value="0"/>
Layer 4	<input type="text" value="1"/>	<input type="text" value="0"/>	<input type="text" value="0"/>

◆ Notes

- Check with a network administrator about IP address. Do not set the duplicate IP address.
- Set IP address on the External Device for IP address in Device-specific settings.
- You need to set IP address on the Display in the offline mode of the Display.

■ Setting of External Device

Use the programming software PCwin to set as below.

◆ Settings of I/O Module

Open [I/O Module Settings] of [Parameter] in the peripheral equipment and set the I/O Module identification code.

Setup Items	Setup Description
Slot No.	0
Assignment Item Number	00
Identification Code	B3
Module Type	Special/Communication
Module Name	Time Chart Module/Computer Link/Ethernet/S-NET

◆ Settings of Link Module

Open the [Link Setting] of [Link Parameter] from [Parameter] in the peripheral equipment. Select the Rack No. and Slot No. to which Ethernet module is assigned, and set the link module name to [Ethernet]. If you also use the PC3J Series CPU program divide mode, please select the correct program number.

Setup Items	Setup Description
Rack No.	Option
Slot No.	Option
Link Module Name	Ethernet

◆ Settings of Communication Parameter

Set as below in the communication parameter.

Setup Items	Setup Description	
Source Node IP Address	192.168.0.1	
Connection	Protocol Open Method	TCP target unspecified passive
	Source Node Port No.	1025
	Other Node Table No.	Setting unnecessary

Communication parameter settings include the following two methods.

A. Setting method in the link parameter setting screen of the peripheral equipment.

To use this setting method, the programming software PCwin is necessary. You cannot use other software or tools to set the communication parameter with link parameters.

- 1 Select [Detail Settings] of [Link Parameter] from [Parameter] in the peripheral equipment to display [Communication Parameter Setting Screen].
- 2 Display the [Ethernet Setting] screen to set each parameter.

Setup Items	Setup Description
Source Node IP Address	192.168.0.1
Connection	Option (1 - 8)
Protocol Open Method	TCP target unspecified passive
Source Node Port No.	1025
Other Node Table No.	Setting unnecessary
Initialization	Initialize by link parameters

B. Setting method by the ladder program

Use the ladder program as below to set the communication parameter.

- 1 Set the communication parameter in the register data.
- 2 Use the SPW command of function instruction to transfer the communication parameter to the file memory in the Ethernet module.
- 3 Use the SPW command of function instruction to set the initial request bit of the file memory in the Ethernet module to ON.

Example of communication parameter is shown below.

Source Node IP Address = 192.168.0.1 (C0.A8.00.01h)

Use Connection No.1, 2, 3 and Other Node Table No.1, 2

Connection 1: TCP active, Port No.6000 (1770h), Other Node Table No.1

Connection 2: TCP target specified passive, Port No.6001 (1771h), Other Node Table No.2

Connection 3: TCP target unspecified passive, Port No.6002 (1772h)

Other Node Table 1: IP Address = 192.168.0.2 (C0.A8.00.02h), Port No. 8000 (1F40h)

Other Node Table 2: IP Address = 192.168.0.3 (C0.A8.00.03h), Port No. 8001 (1F41h)

Register Data	Setting Data	Data Description
R0104	0001	Source Node IP Address (Low)
R0105	C0A8	Source Node IP Address (High)
R0106	0307	Table (1, 2) used/Connection (1, 2, 3) used
R0107	0000	Connection (9 - 16) used
R0108	0000	Connection 1: TCP active
R0109	1770	Connection 1: Port No.
R010A	0001	Connection 1: Other Node Table No.
R010B	0000	0000 Fixed
R010C	0100	Connection 2: TCP target specified passive
R010D	1771	Connection 2: Port No.
R010E	0002	Connection 2: Other Node Table No.
R010F	0000	0000 Fixed
R0110	0200	Connection 3: TCP target unspecified passive
R0111	1772	Connection 3: Port No.
R0112	0000	Connection 3: Other Node Table No.
R0113	0000	0000 Fixed
R0114- R0127	0000	No setting for Connection 4 - 8 (not used)
R0128	0002	Other Node Table 1: Other Node IP Address (Low)
R0129	C0A8	Other Node Table 1: Other Node IP Address (High)
R012A	1F40	Other Node Table 1: Other Node Port No.
R012B	0000	0000 Fixed
R012C	0003	Other Node Table 2: Other Node IP Address (Low)
R012D	C0A8	Other Node Table 2: Other Node IP Address (High)
R012E	1F41	Other Node Table 2: Other Node Port No.
R012F	0000	0000 Fixed

◆ Example of Ladder Program

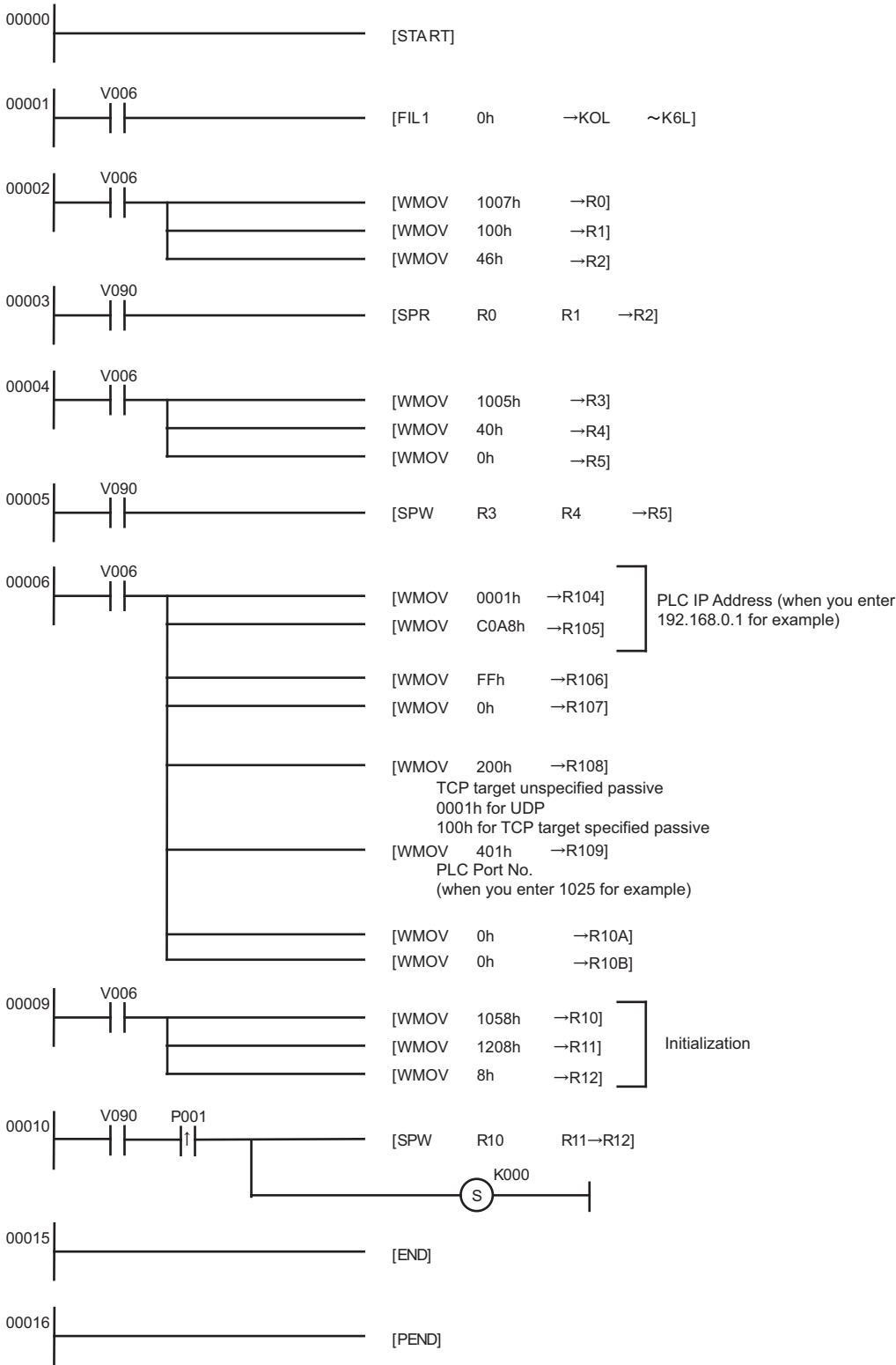

- NOTE** • When the communication parameter is set by both the link parameter and the ladder program, the setting by the link parameter normally is given priority. However, when you select [Initialize by Initial Sequence Program] in the link parameter setting screen, the setting by the ladder program becomes effective even if the link parameter is set.
-

◆ Notes

- Check with a network administrator about IP address. Do not set the duplicate IP address.
- Please refer to the manual of the External Device for more details.

3.6 Setting Example 6

■ Settings of GP-Pro EX

◆ Communication Settings

To display the setup screen, from the [Project] menu, point to [System Settings] and select [Device/PLC].

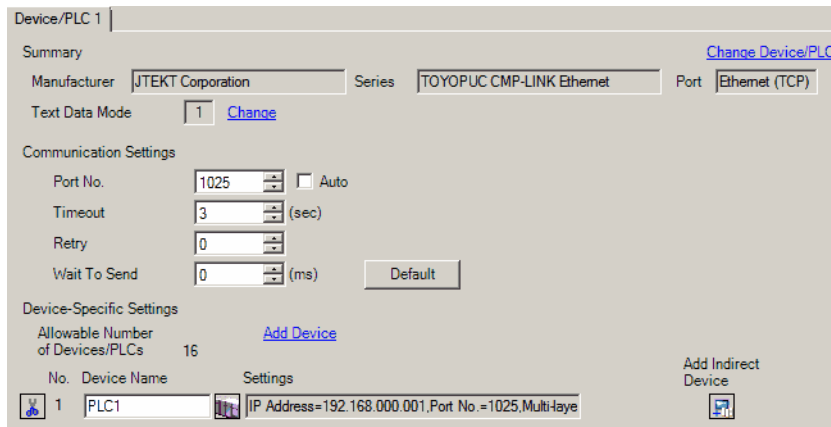

◆ Device Setting

To display the [Individual Device Settings] dialog box, from [Device-Specific Settings] in the [Device/PLC] window, select the External Device and click [Settings]. To connect multiple External Devices, from [Device-Specific Settings] in the [Device/PLC] window, click [Add Device] to add another External Device.

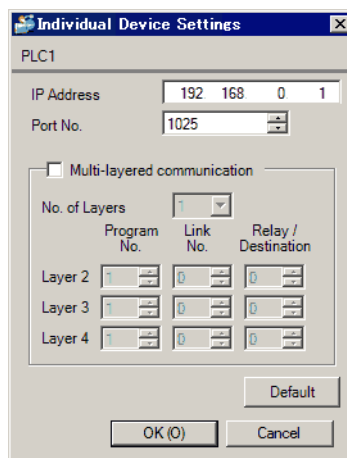

◆ Notes

- Check with a network administrator about IP address. Do not set the duplicate IP address.
- Set IP address on the External Device for IP address in Device-specific settings.
- You need to set IP address on the Display in the offline mode of the Display.

■ Setting of External Device

Use the programming software PCwin to set as below.

◆ Settings of I/O Module

Open [I/O Module Settings] of [Parameter] in the peripheral equipment and set the I/O Module identification code.

Setup Items	Setup Description
Slot No.	0
Assignment Item Number	00
Identification Code	B3
Module Type	Special/Communication
Module Name	Time Chart Module/Computer Link/Ethernet/S-NET

◆ Settings of Link Module

Open the [Link Setting] of [Link Parameter] from [Parameter] in the peripheral equipment. Select the Rack No. and Slot No. to which Ethernet module is assigned, and set the link module name to [Ethernet]. If you also use the PC3J Series CPU program divide mode, please select the correct program number.

Setup Items	Setup Description
Rack No.	Option
Slot No.	Option
Link Module Name	Ethernet

◆ Settings of Communication Parameter

Set as below in the communication parameter.

Setup Items	Setup Description	
Source Node IP Address	192.168.0.1	
Connection	Protocol Open Method	TCP target specified passive
	Source Node Port No.	1025
	Other Node Table No.	Preset other node table No.
Other Node Table	CPU Operation Mode	PC3
	Other Node IP Address	Set IP address of the Display.
	Other Node Port No.	Set the port No. of the Display.

Communication parameter settings include the following two methods.

A. Setting method in the link parameter setting screen of the peripheral equipment.

To use this setting method, the programming software PCwin is necessary. You cannot use other software or tools to set the communication parameter with link parameters.

- 1 Select [Detail Settings] of [Link Parameter] from [Parameter] in the peripheral equipment to display [Communication Parameter Setting Screen].
- 2 Display the [Ethernet Setting] screen to set each parameter.

Setup Items	Setup Description
Source Node IP Address	192.168.0.1
Connection	Option (1 - 8)
Protocol Open Method	TCP target specified passive
Source Node Port No.	1025
Other Node Table No.	Preset other node table No.
Initialization	Initialize by link parameters

- 3 Select [Other Node Table Setting] in the [Ethernet Setting] screen to set other node tables.

Setup Items	Setup Description
Table	Option (1 - 16)
Other Node IP Address	Set IP address of the Display.
Other Node Port No.	Set the port No. of the Display.

B. Setting method by the ladder program

Use the ladder program as below to set the communication parameter.

- 1 Set the communication parameter in the register data.
- 2 Use the SPW command of function instruction to transfer the communication parameter to the file memory in the Ethernet module.
- 3 Use the SPW command of function instruction to set the initial request bit of the file memory in the Ethernet module to ON.

Example of communication parameter is shown below.

Source Node IP Address = 192.168.0.1 (C0.A8.00.01h)

Use Connection No.1, 2, 3 and Other Node Table No.1, 2

Connection 1: TCP active, Port No.6000 (1770h), Other Node Table No.1

Connection 2: TCP target specified passive, Port No.6001 (1771h), Other Node Table No.2

Connection 3: TCP target unspecified passive, Port No.6002 (1772h)

Other Node Table 1: IP Address = 192.168.0.2 (C0.A8.00.02h), Port No. 8000 (1F40h)

Other Node Table 2: IP Address = 192.168.0.3 (C0.A8.00.03h), Port No. 8001 (1F41h)

Register Data	Setting Data	Data Description
R0104	0001	Source Node IP Address (Low)
R0105	C0A8	Source Node IP Address (High)
R0106	0307	Table (1, 2) used/Connection (1, 2, 3) used
R0107	0000	Connection (9 - 16) used
R0108	0000	Connection 1: TCP active
R0109	1770	Connection 1: Port No.
R010A	0001	Connection 1: Other Node Table No.
R010B	0000	0000 Fixed
R010C	0100	Connection 2: TCP target specified passive
R010D	1771	Connection 2: Port No.
R010E	0002	Connection 2: Other Node Table No.
R010F	0000	0000 Fixed
R0110	0200	Connection 3: TCP target unspecified passive
R0111	1772	Connection 3: Port No.
R0112	0000	Connection 3: Other Node Table No.
R0113	0000	0000 Fixed
R0114- R0127	0000	No setting for Connection 4 - 8 (not used)
R0128	0002	Other Node Table 1: Other Node IP Address (Low)
R0129	C0A8	Other Node Table 1: Other Node IP Address (High)
R012A	1F40	Other Node Table 1: Other Node Port No.
R012B	0000	0000 Fixed
R012C	0003	Other Node Table 2: Other Node IP Address (Low)
R012D	C0A8	Other Node Table 2: Other Node IP Address (High)
R012E	1F41	Other Node Table 2: Other Node Port No.
R012F	0000	0000 Fixed

◆ Example of Ladder Program

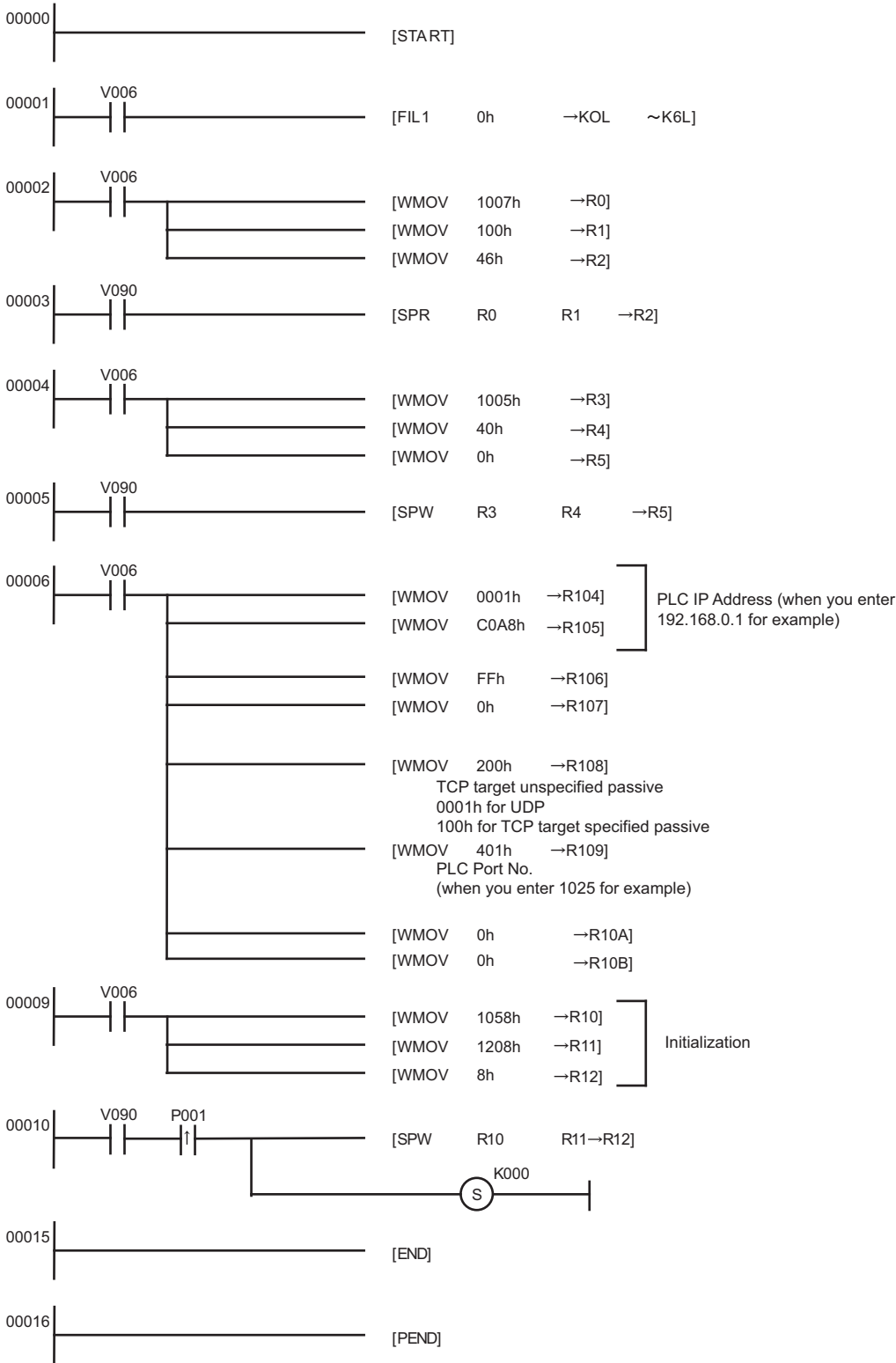

-
- | | |
|-------------|---|
| NOTE | <ul style="list-style-type: none">• When the communication parameter is set by both the link parameter and the ladder program, the setting by the link parameter normally is given priority. However, when you select [Initialize by Initial Sequence Program] in the link parameter setting screen, the setting by the ladder program becomes effective even if the link parameter is set. |
|-------------|---|
-

◆ Notes

- Check with a network administrator about IP address. Do not set the duplicate IP address.
- Please refer to the manual of the External Device for more details.

3.7 Setting Example 7

■ Settings of GP-Pro EX

◆ Communication Settings

To display the setup screen, from the [Project] menu, point to [System Settings] and select [Device/PLC].

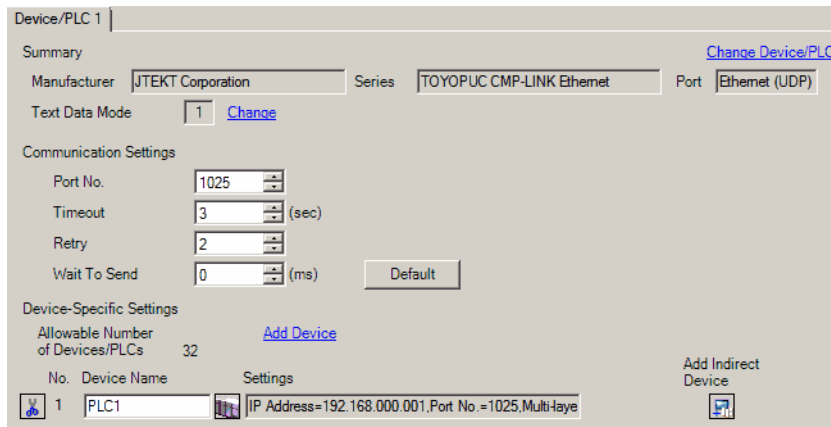

◆ Device Setting

To display the [Individual Device Settings] dialog box, from [Device-Specific Settings] in the [Device/PLC] window, select the External Device and click [Settings]. To connect multiple External Devices, from [Device-Specific Settings] in the [Device/PLC] window, click [Add Device] to add another External Device.

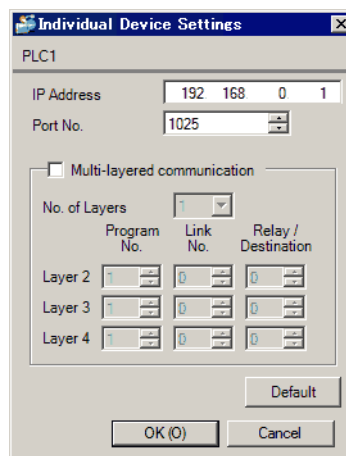

◆ Notes

- Check with a network administrator about IP address. Do not set the duplicate IP address.
- Set IP address on the External Device for IP address in Device-specific settings.
- You need to set IP address on the Display in the offline mode of the Display.

■ Setting of External Device

Communication settings are made with the ladder software (PCwin). For details on the settings, refer to the Device/PLC Manual.

- 1 Start the ladder software to start a project.
- 2 "PC10 Standard" is specified for [CPU Mode] in the project tree.
- 3 Double-click [Link Parameter] in the project tree.
- 4 Select the Link No. that you specify the link module in the [Link parameter setup] dialog box, and click [Link setup].
- 5 Select a link module you use from [Link module name], and click [OK].

NOTE • "Ethernet (32 ports)" can be specified only when the CPU version is V.3.00 or later.

- 6 Click [Detail] with the specified link module selected and make the settings as shown below.

Setup Items	Setup Description
Own Node IP Address	192.168.0.1
Connection 1	Used
Open Protocol	UDP
Own Node Port No.	1025
Other Node Table No.	1
Initialize	Initialization based on Link Parameter

- 7 Click [Other Node Table] and make the settings as shown below.

Setup Items	Setup Description
Table 1	Used
Other Node IP Address	192.168.0.2
Other Node Port No.	1025

- 8 Write the communication settings in the External Device. After the writing is completed, restart the External Device.

3.8 Setting Example 8

■ Settings of GP-Pro EX

◆ Communication Settings

To display the setup screen, from the [Project] menu, point to [System Settings] and select [Device/PLC].

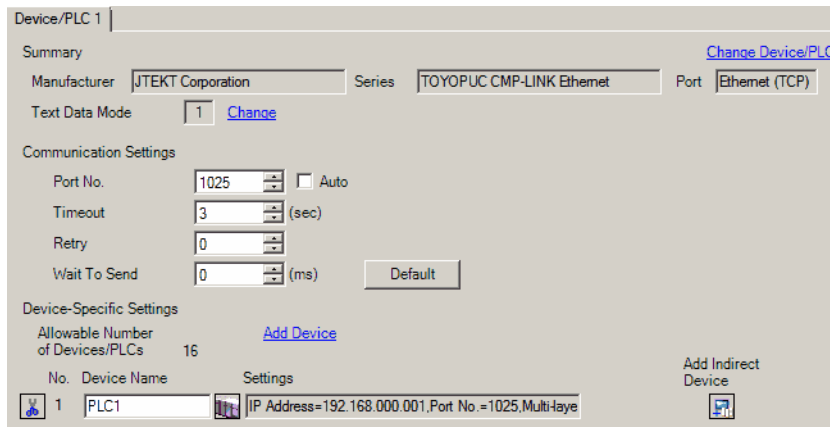

◆ Device Setting

To display the [Individual Device Settings] dialog box, from [Device-Specific Settings] in the [Device/PLC] window, select the External Device and click [Settings]. To connect multiple External Devices, from [Device-Specific Settings] in the [Device/PLC] window, click [Add Device] to add another External Device.

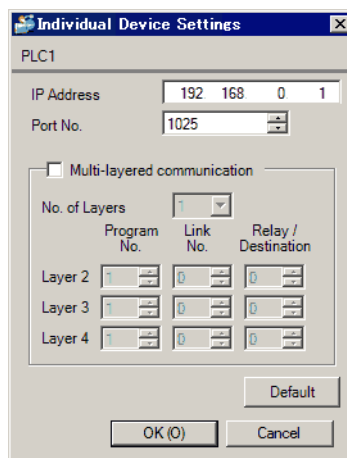

◆ Notes

- Check with a network administrator about IP address. Do not set the duplicate IP address.
- Set IP address on the External Device for IP address in Device-specific settings.
- You need to set IP address on the Display in the offline mode of the Display.

■ Setting of External Device

Communication settings are made with the ladder software (PCwin). For details on the settings, refer to the Device/PLC Manual.

- 1 Start the ladder software to start a project.
- 2 "PC10 Standard" is specified for [CPU Mode] in the project tree.
- 3 Double-click [Link Parameter] in the project tree.
- 4 Select the Link No. that you specify the link module in the [Link parameter setup] dialog box, and click [Link setup].
- 5 Select a link module you use from [Link module name], and click [OK].

NOTE • "Ethernet (32 ports)" can be specified only when the CPU version is V.3.00 or later.

- 6 Click [Detail] with the specified link module selected and make the settings as shown below.

Setup Items	Setup Description
Own Node IP Address	192.168.0.1
Connection 1	Used
Open Protocol	TCP Destination Non-Specified Passive Open
Own Node Port No.	1025
Initialize	Initialization based on Link Parameter

- 7 Write the communication settings in the External Device. After the writing is completed, restart the External Device.

3.9 Setting Example 9

■ Settings of GP-Pro EX

◆ Communication Settings

To display the setup screen, from the [Project] menu, point to [System Settings] and select [Device/PLC].

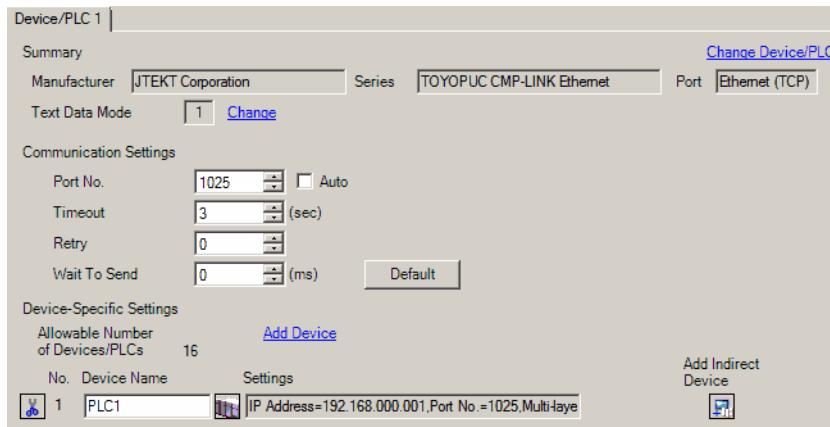

◆ Device Setting

To display the [Individual Device Settings] dialog box, from [Device-Specific Settings] in the [Device/PLC] window, select the External Device and click [Settings]. To connect multiple External Devices, from [Device-Specific Settings] in the [Device/PLC] window, click [Add Device] to add another External Device.

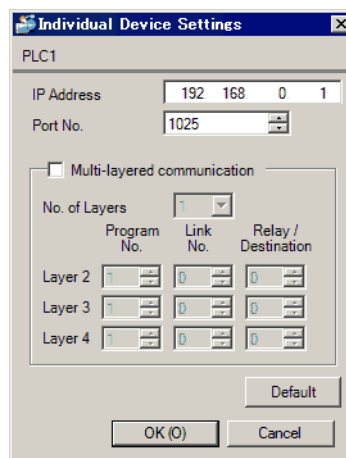

◆ Notes

- Check with a network administrator about IP address. Do not set the duplicate IP address.
- Set IP address on the External Device for IP address in Device-specific settings.
- You need to set IP address on the Display in the offline mode of the Display.

■ Setting of External Device

Communication settings are made with the ladder software (PCwin). For details on the settings, refer to the Device/PLC Manual.

- 1 Start the ladder software to start a project.
- 2 "PC10 Standard" is specified for [CPU Mode] in the project tree.
- 3 Double-click [Link Parameter] in the project tree.
- 4 Select the Link No. that you specify the link module in the [Link parameter setup] dialog box, and click [Link setup].
- 5 Select a link module you use from [Link module name], and click [OK].

NOTE • "Ethernet (32 ports)" can be specified only when the CPU version is V.3.00 or later.

- 6 Click [Detail] with the specified link module selected and make the settings as shown below.

Setup Items	Setup Description
Own Node IP Address	192.168.0.1
Connection 1	Used
Open Protocol	TCP Destination-Specified Passive Open
Own Node Port No.	1025
Other Node Table No.	1
Initialize	Initialization based on Link Parameter

- 7 Click [Other Node Table] and make the settings as shown below.

Setup Items	Setup Description
Table 1	Used
Other Node IP Address	192.168.0.2
Other Node Port No.	1025

- 8 Write the communication settings in the External Device. After the writing is completed, restart the External Device.

4 Setup Items

Set communication settings of the Display with GP-Pro EX or in offline mode of the Display.

The setting of each parameter must be identical to that of External Device.

☞ "3 Example of Communication Setting" (page 7)

NOTE • Set the Display's IP address in offline mode.

Cf. Maintenance/Troubleshooting Manual "Ethernet Settings"

4.1 Setup Items in GP-Pro EX

■ Communication Settings

To display the setup screen, from the [Project] menu, point to [System Settings] and select [Device/PLC].

The screenshot shows the 'Device/PLC 1' configuration window. It includes sections for 'Summary', 'Communication Settings', and 'Device-Specific Settings'. In the 'Communication Settings' section, 'Port No.' is 1025, 'Timeout' is 3 (sec), 'Retry' is 0, and 'Wait To Send' is 0 (ms). The 'Device-Specific Settings' section shows 'Allowable Number of Devices/PLCs' as 16 and a table with one entry: '1 | PLC1 | IP Address=192.168.000.001,Port No.=1025,Multi-laye'.

Setup Items	Setup Description
Port No.	Use an integer from 1025 to 65534 to enter the port No. of the Display. When you check the option of [Auto Assign], the port No. will be automatically set. NOTE • [Auto Assign] option is available to set only when you select "Ethernet (TCP)" in [Connecting Method].
Timeout	Use an integer from 1 to 127 to enter the time (s) for which the Display waits for the response from the External Device.
Retry	In case of no response from the External Device, use an integer from 0 to 255 to enter how many times the Display retransmits the command.
Wait To Send	Use an integer from 0 to 255 to enter standby time (ms) for the Display from receiving packets to transmitting next commands.

NOTE • Refer to the GP-Pro EX Reference Manual for Indirect Device.

Cf. GP-Pro EX Reference Manual "Changing the Device/PLC at Runtime (Indirect Device)"

■ Device Setting

To display the [Individual Device Settings] dialog box, from [Device-Specific Settings] in the [Device/PLC] window, select the External Device and click [Settings] . To connect multiple External Devices, from [Device-Specific Settings] in the [Device/PLC] window, click [Add Device] to add another External Device.

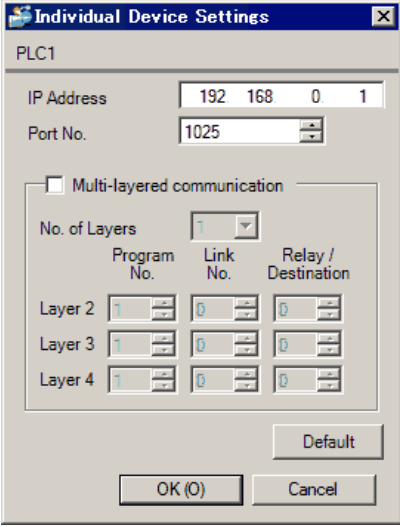

Setup Items	Setup Description
IP Address	Set IP address of the External Device. NOTE <ul style="list-style-type: none"> Check with a network administrator about IP address. Do not set the duplicate IP address.
Port No.	Use an integer from 1025 to 65534 to enter the port No. of the External Device.
Multi-layered communication	Select this check box when communicating with equipment on FL-NET.
No. of Layers	Enter the number of layers you are using on FL-NET, from 2 to 4.
Program No.	Enter the program number (1 to 3) of equipment used as a relay or as the destination.
Link No.	Enter the link number (0 to 8) of equipment used as a relay or as the destination.
Relay / Destination	Enter the node number (0 to 255) of equipment used as a relay or as the destination.

4.2 Setup Items in Offline Mode

- NOTE** • Refer to the Maintenance/Troubleshooting manual for information on how to enter offline mode or about the operation.

Cf. Maintenance/Troubleshooting Manual "Offline Mode"

■ Communication Settings

To display the setting screen, touch [Device/PLC Settings] from [Peripheral Settings] in offline mode. Touch the External Device you want to set from the displayed list.

Comm.	Device			
TOYOPUC CMP-LINK Ethernet			[UDP]	Page 1/1
Port No.	<input checked="" type="radio"/> Fixed <input type="radio"/> Auto	<input type="text" value="1025"/> ▼ ▲		
Timeout(s)		<input type="text" value="3"/> ▼ ▲		
Retry		<input type="text" value="2"/> ▼ ▲		
Wait To Send(ms)		<input type="text" value="0"/> ▼ ▲		
	Exit		Back	2014/11/28 16:13:02

Setup Items	Setup Description
Port No.	Set the port No. of the Display. In UDP connection, entered port No. will be assigned regardless of whether you select [Fixed] or [Auto]. In TCP connection, select either of [Fixed] or [Auto]. When you select [Fixed], use an integer from 1025 to 65534 to enter the port No. of the Display. When you select [Auto], the port No. will be automatically assigned regardless of the entered value.
Timeout	Use an integer from 1 to 127 to enter the time (s) for which the Display waits for the response from the External Device.
Retry	In case of no response from the External Device, use an integer from 0 to 255 to enter how many times the Display retransmits the command.
Wait To Send	Use an integer from 0 to 255 to enter standby time (ms) for the Display from receiving packets to transmitting next commands.

■ Device Setting

To display the setting screen, touch [Device/PLC Settings] from [Peripheral Settings]. Touch the External Device you want to set from the displayed list, and touch [Device].

Comm.	Device			
TOYOPUC CMP-LINK Ethernet		[UDP]	Page 1/1	
Device/PLC Name		PLC1		
IP Address		192 168 0 1		
Port No.		1025		
Multi-layered communication		No. of Layers 1		
	Program No.	Link No.	Relay/Destination	
Layer 2	1	0	0	
Layer 3	1	0	0	
Layer 4	1	0	0	
Exit		Back		2014/11/28 16:13:06

Setup Items	Setup Description
Device/PLC Name	Select the External Device for device setting. Device name is a title of External Device set with GP-Pro EX.(Initial value [PLC1])
IP Address	Set IP address of the External Device. NOTE <ul style="list-style-type: none"> Check with a network administrator about IP address. Do not set the duplicate IP address.
Port No.	Use an integer from 1025 to 65534 to enter the port No. of the External Device.
No. of Layers	Enter the number of layers you are using on FL-NET, from 1 to 4.
Program No.	Enter the program number (1 to 3) of equipment used as a relay or as the destination.
Link No.	Enter the link number (0 to 8) of equipment used as a relay or as the destination.
Relay/Destination	Enter the node number (0 to 255) of equipment used as a relay or as the destination.

5 Supported Device

Range of supported device address is shown in the table below. Please note that the actually supported range of the devices varies depending on the External Device to be used. Please check the actual range in the manual of your External Device.

5.1 TOYOPUC-PC3

 This address can be specified as system data area.

Device	Bit Address	Word Address	32bits	Notes
Input Relay	1X000 - 1X7FF	1X00W - 1X7FW	[L / H]	*1*3
	2X000 - 2X7FF	2X00W - 2X7FW		
	3X000 - 3X7FF	3X00W - 3X7FW		
Output Relay	1Y000 - 1Y7FF	1Y00W - 1Y7FW		*1*3
	2Y000 - 2Y7FF	2Y00W - 2Y7FW		
	3Y000 - 3Y7FF	3Y00W - 3Y7FW		
Internal Relay	1M000 - 1M7FF	1M00W - 1M7FW		*1
	2M000 - 2M7FF	2M00W - 2M7FW		
	3M000 - 3M7FF	3M00W - 3M7FW		
Keep Relay	1K000 - 1K2FF	1K00W - 1K2FW		*1
	2K000 - 2K2FF	2K00W - 2K2FW		
	3K000 - 3K2FF	3K00W - 3K2FW		
Link Relay	1L000 - 1L7FF	1L00W - 1L7FW		*1
	2L000 - 2L7FF	2L00W - 2L7FW		
	3L000 - 3L7FF	3L00W - 3L7FW		
Special Relay	1V00 - 1VFF	1V0W - 1VFW		*1
	2V00 - 2VFF	2V0W - 2VFW		
	3V00 - 3VFF	3V0W - 3VFW		
Timer (Contact)	1T000 - 1T1FF	1T00W - 1T1FW		*1 *3
	2T000 - 2T1FF	2T00W - 2T1FW		
	3T000 - 3T1FF	3T00W - 3T1FW		
Counter (Contact)	1C000 - 1C1FF	1C00W - 1C1FW		*1*3
	2C000 - 2C1FF	2C00W - 2C1FW		
	3C000 - 3C1FF	3C00W - 3C1FW		

Device	Bit Address	Word Address	32bits	Notes
Current Value Register	1N000-0 - 1N1FF-F	1N000 - 1N1FF	[L/H]	*2
	2N000-0 - 2N1FF-F	2N000 - 2N1FF		
	3N000-0 - 3N1FF-F	3N000 - 3N1FF		
Data Register	1D0000-0 - 1D2FFF-F	1D0000 - 1D2FFF		*2
	2D0000-0 - 2D2FFF-F	2D0000 - 2D2FFF		
	3D0000-0 - 3D2FFF-F	3D0000 - 3D2FFF		
Link Register	1R000-0 - 1R7FF-F	1R000 - 1R7FF		*2
	2R000-0 - 2R7FF-F	2R000 - 2R7FF		
	3R000-0 - 3R7FF-F	3R000 - 3R7FF		
Special Register	1S000-0 - 1S3FF-F	1S000 - 1S3FF		*2
	2S000-0 - 2S3FF-F	2S000 - 2S3FF		
	3S000-0 - 3S3FF-F	3S000 - 3S3FF		
File Register	B0000-0 - B1FFF-F	B0000 - B1FFF		*2
Extension Input	EX000 - EX7FF	EX00W - EX7FW		*1 *3
Extension Output	EY000 - EY7FF	EY00W - EY7FW		*1 *3
Extension Internal Relay	EM0000 - EM1FFF	EM000W - EM1FFW		*1
Extension Special Relay	EV000 - EVFFF	EV00W - EVFFW		*1
Extension Keep Relay	EK000 - EKFFF	EK00W - EKFFW		*1
Extension Timer	ET000 - ET7FF	ET00W - ET7FW		*1 *3
Extension Counter	EC000 - EC7FF	EC00W - EC7FW		*1 *3
Extension Link Relay	EL0000 - EL1FFF	EL000W - EL1FFW		*1
Extension 2 Input	GX0000 - GXFFFF	GX000W - GXFFFW	*1 *3	
Extension 2 Output	GY0000 - GYFFFF	GY000W - GYFFFW	*1 *3	
Extension 2 Internal Relay	GM0000 - GMFFFF	GM000W - GMFFFW	*1	
Extension Data Register	U0000-0 - U7FFF-F	U0000 - U7FFF	*2	
Extension Setting Value Register	H000-0 - H7FF-F	H000 - H7FF	*2	
Extension Special Register	ES000-0 - ES7FF-F	ES000 - ES7FF	*2	
Extension Current Value Register	EN000-0 - EN7FF-F	EN000 - EN7FF	*2	
Watch Time Register	-----	WT0 - WT6	*4 *5	
Extended Buffer Register	EB00000-0 - EB1FFFF-F	EB00000 - EB1FFFF	*2	

- *1 For word description of the bit device, add "W" to the last of the word address.
Example) When the address is 0 in M device, describe "M0000W".
- *2 For bit description of the word device, describe "-" following the word address and the bit position next.
Example) When the address is 0 and the bit is 5 in D device, describe " D0000-5".
- *3 You cannot set the duplicate address for X and Y (EX, EY, GX, GY), T and C (ET, EC).
(Setting such address as X000/Y000, EX000/EY000, T000/C000, ET000/EC000 is wrong.)
- *4 When you write "Watch Time Register", the Display reads all addresses of "Watch Time Register" in the External Device. Then the Display writes all addresses of "Watch Time Register" after the Display changes the data of your requested address. Note that the correct data may not be written if you change the word address using the ladder program while the Display reads data from the External Device and returns it.
- *5 Contents of "Watch Time Register" are shown below.

Address	Mean	Note
WT0	day of week	0:Sunday, 1:Monday, 2:Tuesday, 3:Wednesday, 4:Thursday, 5:Friday, 6:Saturday
WT1	year	lower two digits of A.D.
WT2	month	
WT3	day	
WT4	hour	24-hour system
WT5	minute	
WT6	second	

NOTE

- Please refer to the GP-Pro EX Reference Manual for system data area.
Cf. GP-Pro EX Reference Manual "LS Area (Direct Access Method Area)"
- Please refer to the precautions on manual notation for icons in the table.

 "Manual Symbols and Terminology"

5.2 TOYOPUC-PC10G

 This address can be specified as system data area.

Device	Bit Address	Word Address	32bits	Notes
Input Relay	1X000 - 1X7FF	1X00W - 1X7FW	L/H	*1*3
	2X000 - 2X7FF	2X00W - 2X7FW		
	3X000 - 3X7FF	3X00W - 3X7FW		
Output Relay	1Y000 - 1Y7FF	1Y00W - 1Y7FW		*1*3
	2Y000 - 2Y7FF	2Y00W - 2Y7FW		
	3Y000 - 3Y7FF	3Y00W - 3Y7FW		
Internal Relay	1M000 - 1M7FF	1M00W - 1M7FW		*1
	2M000 - 2M7FF	2M00W - 2M7FW		
	3M000 - 3M7FF	3M00W - 3M7FW		
Keep Relay	1K000 - 1K2FF	1K00W - 1K2FW		*1
	2K000 - 2K2FF	2K00W - 2K2FW		
	3K000 - 3K2FF	3K00W - 3K2FW		
Link Relay	1L000 - 1L7FF	1L00W - 1L7FW		*1
	2L000 - 2L7FF	2L00W - 2L7FW		
	3L000 - 3L7FF	3L00W - 3L7FW		
Special Relay	1V00 - 1VFF	1V0W - 1VFW		*1
	2V00 - 2VFF	2V0W - 2VFW		
	3V00 - 3VFF	3V0W - 3VFW		
Timer (Contact)	1T000 - 1T1FF	1T00W - 1T1FW		*1 *3
	2T000 - 2T1FF	2T00W - 2T1FW		
	3T000 - 3T1FF	3T00W - 3T1FW		
Counter (Contact)	1C000 - 1C1FF	1C00W - 1C1FW		*1*3
	2C000 - 2C1FF	2C00W - 2C1FW		
	3C000 - 3C1FF	3C00W - 3C1FW		
Current Value Register	1N000-0 - 1N1FF-F	1N000 - 1N1FF		*2
	2N000-0 - 2N1FF-F	2N000 - 2N1FF		
	3N000-0 - 3N1FF-F	3N000 - 3N1FF		
Data Register	1D0000-0 - 1D2FFF-F	1D0000 - 1D2FFF		*2
	2D0000-0 - 2D2FFF-F	2D0000 - 2D2FFF		
	3D0000-0 - 3D2FFF-F	3D0000 - 3D2FFF		

Device	Bit Address	Word Address	32bits	Notes
Link Register	1R000-0 - 1R7FF-F	1R000 - 1R7FF	[L/H]	*2
	2R000-0 - 2R7FF-F	2R000 - 2R7FF		
	3R000-0 - 3R7FF-F	3R000 - 3R7FF		
Special Register	1S000-0 - 1S3FF-F	1S000 - 1S3FF		*2
	2S000-0 - 2S3FF-F	2S000 - 2S3FF		
	3S000-0 - 3S3FF-F	3S000 - 3S3FF		
File Register	B0000-0 - B1FFF-F	B0000 - B1FFF		*2
Extension Input	EX000 - EX7FF	EX00W - EX7FW		*1 *3
Extension Output	EY000 - EY7FF	EY00W - EY7FW		*1*3
Extension Internal Relay	EM0000 - EM1FFF	EM000W - EM1FFW		*1
Extension Special Relay	EV000 - EVFFF	EV00W - EVFFW		*1
Extension Keep Relay	EK000 - EKFFF	EK00W - EKFFW		*1
Extension Timer	ET000 - ET7FF	ET00W - ET7FW		*1 *3
Extension Counter	EC000 - EC7FF	EC00W - EC7FW		*1 *3
Extension Link Relay	EL0000 - EL1FFF	EL000W - EL1FFW		*1
Extension 2 Input	GX0000 - GXFFFF	GX000W - GXFFFW		*1 *3
Extension 2 Output	GY0000 - GYFFFF	GY000W - GYFFFW		*1 *3
Extension 2 Internal Relay	GM0000 - GMFFFF	GM000W - GMFFFW		*1
Extension Data Register	U00000-0 - U1FFFF-F	U00000 - U1FFFF		*2
Extension Setting Value Register	H000-0 - H7FF-F	H000 - H7FF		*2
Extension Special Register	ES000-0 - ES7FF-F	ES000 - ES7FF	*2	
Extension Current Value Register	EN000-0 - EN7FF-F	EN000 - EN7FF	*2	
Watch Time Register	-----	WT0 - WT6	*4 *5	
Extended buffer register	EB00000-0 - EB3FFFF-F	EB00000 - EB3FFFF	*2	
Extended flash register	FR000000-0 - FR1FFFFF-F	FR000000 - FR1FFFFF	*2 *6	

*1 For word description of the bit device, add "W" to the last of the word address.
Example) When the address is 0 in M device, describe "M0000W".

*2 For bit description of the word device, describe "-" following the word address and the bit position next.
Example) When the address is 0 and the bit is 5 in D device, describe "D0000-5".

*3 You cannot set the duplicate address for X and Y (EX, EY, GX, GY), T and C (ET, EC).
(Setting such address as X000/Y000, EX000/EY000, T000/C000, ET000/EC000 is wrong.)

- *4 When you write "Watch Time Register", the Display reads all addresses of "Watch Time Register" in the External Device. Then the Display writes all addresses of "Watch Time Register" after the Display changes the data of your requested address. Note that the correct data may not be written if you change the word address using the ladder program while the Display reads data from the External Device and returns it.
- *5 Contents of "Watch Time Register" are shown below.

Address	Mean	Note
WT0	day of week	0:Sunday, 1:Monday, 2:Tuesday, 3:Wednesday, 4:Thursday, 5:Friday, 6:Saturday
WT1	year	lower two digits of A.D.
WT2	month	
WT3	day	
WT4	hour	24-hour system
WT5	minute	
WT6	second	

- *6 You can read from and write to the extended flash register. However, you cannot write values to flash memory. Use the ladder software to write values to flash memory.

NOTE

- Please refer to the GP-Pro EX Reference Manual for system data area.
Cf. GP-Pro EX Reference Manual "LS Area (Direct Access Method Area)"
- Please refer to the precautions on manual notation for icons in the table.
 "Manual Symbols and Terminology"

6 Device Code and Address Code

Use device code and address code when you select "Device Type & Address" for the address type in data displays.

6.1 TOYOPUC-PC3

Device	Device Name	Device Code (HEX)	Address Code
Input Relay	1X	0080	Word Address
	2X	0180	Word Address
	3X	0280	Word Address
Output Relay	1Y	0081	Word Address
	2Y	0181	Word Address
	3Y	0281	Word Address
Internal Relay	1M	0082	Word Address
	2M	0182	Word Address
	3M	0282	Word Address
Keep Relay	1K	0084	Word Address
	2K	0184	Word Address
	3K	0284	Word Address
Link Relay	1L	0088	Word Address
	2L	0188	Word Address
	3L	0288	Word Address
Special Relay	1V	0083	Word Address
	2V	0183	Word Address
	3V	0283	Word Address
Timer (Contact)	1T	0086	Word Address
	2T	0186	Word Address
	3T	0286	Word Address
Counter (Contact)	1C	0087	Word Address
	2C	0187	Word Address
	3C	0287	Word Address
Special Register	1S	0001	Word Address
	2S	0101	Word Address
	3S	0201	Word Address

Device	Device Name	Device Code (HEX)	Address Code
Current Value Register	1N	0003	Word Address
	2N	0103	Word Address
	3N	0203	Word Address
Data Register	1D	0000	Word Address
	2D	0100	Word Address
	3D	0200	Word Address
Link Register	1R	0002	Word Address
	2R	0102	Word Address
	3R	0202	Word Address
File Register	B	0004	Word Address
Extension Setting Value Register	H	0006	Word Address
Extension Data Register	U	0005	Word Address
Extension Input	EX	0090	Word Address
Extension Output	EY	0091	Word Address
Extension Internal Relay	EM	0092	Word Address
Extension Keep Relay	EK	0094	Word Address
Extension Link Relay	EL	0098	Word Address
Extension Special Relay	EV	0093	Word Address
Extension Timer	ET	0096	Word Address
Extension Counter	EC	0097	Word Address
Extension Special Register	ES	0011	Word Address
Extension Current Value Register	EN	0013	Word Address
Extension 2 Input	GX	00A0	Word Address
Extension 2 Output	GY	00A1	Word Address
Extension 2 Internal Relay	GM	00A2	Word Address
Watch Time Register	WT	0007	Word Address
Extended Buffer Register	EB	0014	Word Address

6.2 TOYOPUC-PC10G

Device	Device Name	Device Code (HEX)	Address Code
Input Relay	1X	0080	Word Address
	2X	0180	Word Address
	3X	0280	Word Address
Output Relay	1Y	0081	Word Address
	2Y	0181	Word Address
	3Y	0281	Word Address
Internal Relay	1M	0082	Word Address
	2M	0182	Word Address
	3M	0282	Word Address
Keep Relay	1K	0084	Word Address
	2K	0184	Word Address
	3K	0284	Word Address
Link Relay	1L	0088	Word Address
	2L	0188	Word Address
	3L	0288	Word Address
Special Relay	1V	0083	Word Address
	2V	0183	Word Address
	3V	0283	Word Address
Timer (Contact)	1T	0086	Word Address
	2T	0186	Word Address
	3T	0286	Word Address
Counter (Contact)	1C	0087	Word Address
	2C	0187	Word Address
	3C	0287	Word Address
Special Register	1S	0001	Word Address
	2S	0101	Word Address
	3S	0201	Word Address
Current Value Register	1N	0003	Word Address
	2N	0103	Word Address
	3N	0203	Word Address

Device	Device Name	Device Code (HEX)	Address Code
Data Register	1D	0000	Word Address
	2D	0100	Word Address
	3D	0200	Word Address
Link Register	1R	0002	Word Address
	2R	0102	Word Address
	3R	0202	Word Address
File Register	B	0004	Word Address
Extension Setting Value Register	H	0006	Word Address
Extension Data Register	U	0005	Word Address
Extension Input	EX	0090	Word Address
Extension Output	EY	0091	Word Address
Extension Internal Relay	EM	0092	Word Address
Extension Keep Relay	EK	0094	Word Address
Extension Link Relay	EL	0098	Word Address
Extension Special Relay	EV	0093	Word Address
Extension Timer	ET	0096	Word Address
Extension Counter	EC	0097	Word Address
Extension Special Register	ES	0011	Word Address
Extension Current Value Register	EN	0013	Word Address
Extension 2 Input	GX	00A0	Word Address
Extension 2 Output	GY	00A1	Word Address
Extension 2 Internal Relay	GM	00A2	Word Address
Watch Time Register	WT	0007	Word Address
Extended buffer register	EB	0014	Word Address
Extended flash register	FR	0018	Word Address

7 Error Messages

Error messages are displayed on the screen of Display as follows: "No. : Device Name: Error Message (Error Occurrence Area)". Each description is shown below.

Item	Description
No.	Error No.
Device Name	Name of External Device where error occurs. Name of External Device is a title of External Device set with GP-Pro EX.(Initial value [PLC1])
Error Message	Displays messages related to the error which occurs.
Error Occurrence Area	<p>Displays IP address or device address of External Device where error occurs, or error codes received from External Device.</p> <p>NOTE</p> <ul style="list-style-type: none"> • IP address is displayed as "IP address (Decimal): MAC address (Hex)". • Device address is displayed as "Address: Device address". • Received error codes are displayed as "Decimal [Hex]".

Display Examples of Error Messages

"RHAA035: PLC1: Error has been responded for device write command (Error Code: 2 [02H])"

-
- NOTE**
- Refer to your External Device manual for details on received error codes.
 - Refer to "When an error is displayed (Error Code List)" in "Maintenance/Troubleshooting Manual" for details on the error messages common to the driver.
-

■ Error Messages Unique to External Device

Message ID	Error Message	Description
RHxx128	(Node Name): PC2 Mode is not supported.	PC2 mode is not supported.
RHxx129	(Node Name): [Device Name] device is not supported in PC3 Mode.	The specified device is not supported in PC3 mode.
RHxx130	(Node Name): Out of range device in PC3 Mode. (Address:[Device Address])	The specified device address is out of the supported range in PC3 mode.