

36



Use the Computer to Display and Operate GP Data

This chapter describes the basic operation and setup of GP-Viewer EX and the Web Server, both of which you can use to display and interact with GP screen data from a computer. First, read the general overview about this feature in "36.1 What are GP-Viewer EX and Web Server?" (page 36-2) , then go to "36.4 Settings Menu" (page 36-18) to find explanations of individual features.

36.1	What are GP-Viewer EX and Web Server?	36-2
36.2	GP-Viewer EX Operation Environment and Development Flow	36-6
36.3	Web Server Operation Environment and Development Flow	36-14
36.4	Settings Menu	36-18
36.5	Using GP-Viewer EX to Display and Operate with Data from Display Units	36-22
36.6	Restricting Access to GP-Viewer EX	36-30
36.7	Displaying Addresses on the Web Server and Changing Address Values	36-35
36.8	Displaying Alarm information on the Web Server	36-48
36.9	Displaying Alarm Information as RSS Data on the Web Server	36-50
36.10	Using the Web Server to Transfer Files to the CF Card or USB Storage....	36-53
36.11	Restricting Access to the Web Server.....	36-60
36.12	Settings Guide.....	36-67
36.13	Using Synchronous and Asynchronous Modes with GP-Viewer EX.....	36-78
36.14	Restrictions	36-86

36.1 What are GP-Viewer EX and Web Server?

You can use GP-Viewer EX and the Web Server to monitor, operate, and maintain data of remote GP display units. Using GP-Viewer EX on your computer, you can remotely view and operate display units, although some features are unavailable for viewing and operation. The Web Server makes alarms and device addresses available, and facilitates simplified maintenance as it displays in Internet Explorer.

The characteristics of each feature are described below. Please select whether to use GP-Viewer EX or Web Server, depending on your environment.

■ Model Environment

In this section, the following system configuration is used as a model to explain the operations and features. In other system configurations, the display and part names may differ. If so, replace the names with those with similar features used in your system configuration.

■ Standard Configuration

Learning material/ software	Model system specifications	Remarks
Operating System	Windows [®] 2000	-
Device/PLC	Mitsubishi Electric Q/QnA Serial Communication Series	-
Select Shape	Internet Explorer 6.0	-

36.1.1 GP-Viewer EX

■ Summary

GP-Viewer EX is an application that displays and operates remotely located display screens. It enables you to recover and monitor activities for troubleshooting and perform daily maintenance.

To use this feature, the computer and display unit must be placed on the same network. GP-Viewer EX must be installed on the computer and the license must be set for the display unit. GP-Viewer EX can be installed from a GP-Pro EX (version 2.10 or higher) CD-ROM or downloaded from the home page.

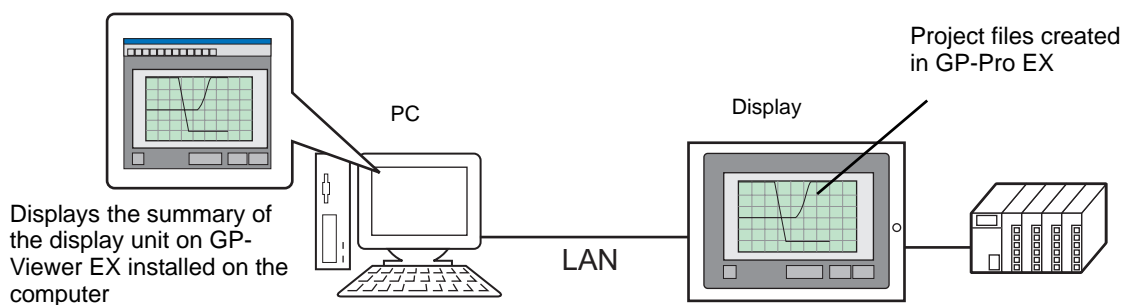

■ License

◆ Key code

To use GP-Viewer EX, a separate license (Type: EX-VIEWER-LICENSE) is required for each display unit. When you purchase this license, documents, including a [Key code], will be issued.

IMPORTANT

- To enter key codes, please refer to the following.
 - ☞ Maintenance/Troubleshooting: "Setting a GP-Viewer EX or RPA license"
- The key code cannot be reissued if lost. Store it securely.

◆ Application

GP-Viewer EX is installed from the following location.

- For installations using a CD-ROM of GP-Pro EX (Ver2.10 or later)
From GP-Pro EX Disk 2's "GPViewerEX" folder, double-click setup.exe to install.
- Pro-face Web site
Download GP-Viewer from our Web site, "Otasuke Pro!"
<http://www.pro-face.com/otasuke/>

NOTE

- For installation procedures, refer to the following.
 - ☞ "36.5.2 Procedure ■ Installing and Uninstalling GP-Viewer EX" (page 36-27)

■ Full Configuration

Connection or option environment when using GP-Viewer EX is as follows.

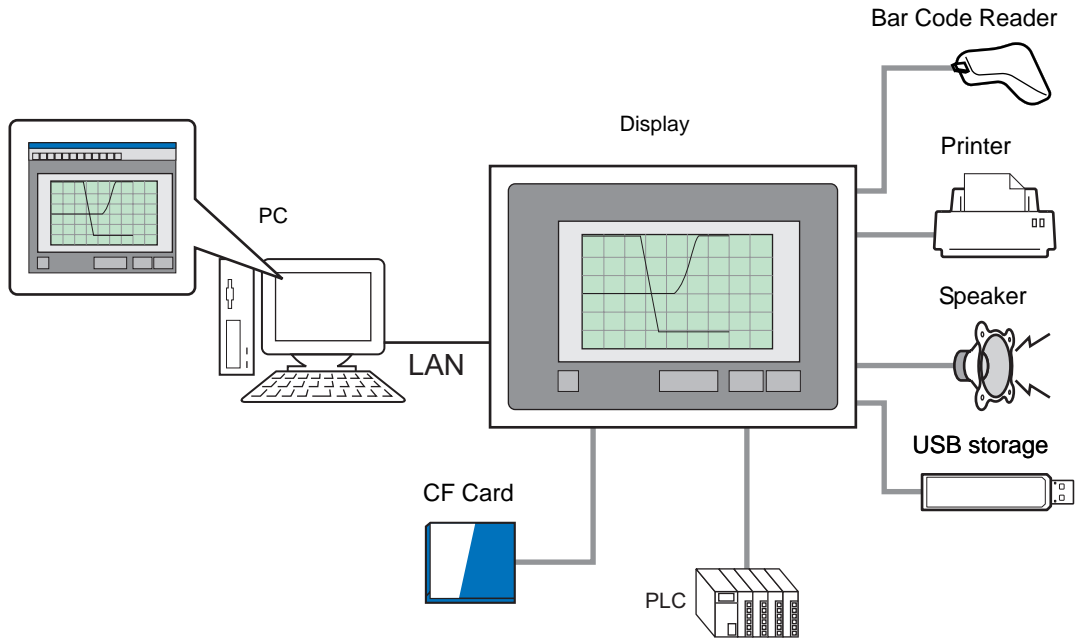

36.1.2 Web Server

■ Summary

The Web Server makes alarms and device addresses available for display in Internet Explorer. You can also access files on a CF Card or a USB storage device, allowing for simple maintenance tasks.

To use the Web Server, the computer and display unit must be on the same network, and in the GP-Pro EX Remote Viewer settings, the [Web Server] group's [Enable Web Server] check box must be selected.

■ License

This feature does not require a license.

The CD for GP-Pro EX version 2.10 or later comes standard with Web Contents. You can use Web Contents by downloading it to the GP, and using a computer attached to the same network to view the web contents on the GP.

■ Full Configuration

The following describes the layout of connections and options when using the Web Server.

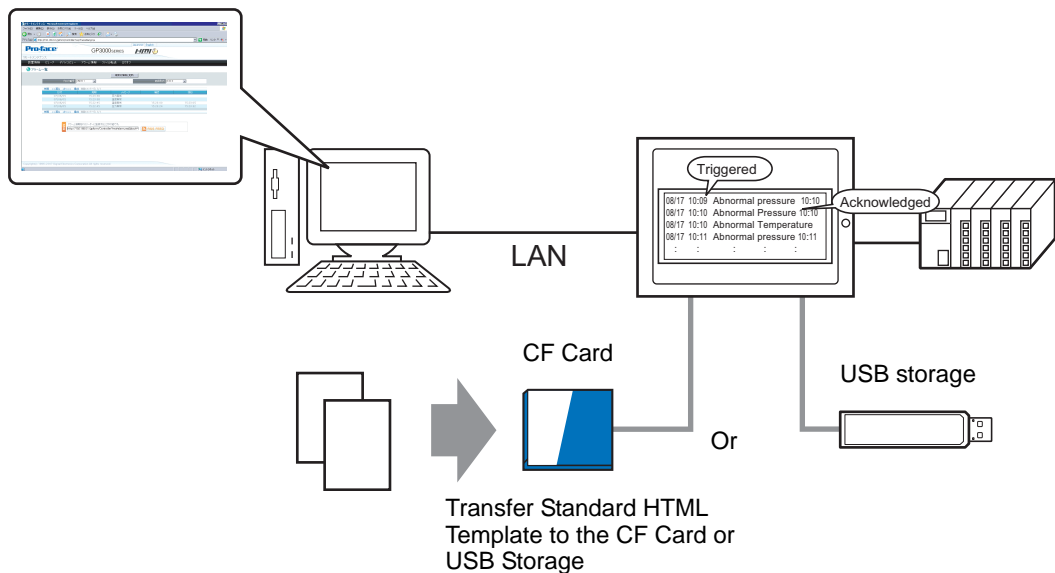

36.2 GP-Viewer EX Operation Environment and Development Flow

36.2.1 Target models

Display models supported by GP-Viewer EX are as follows.

■ Display Units

Series	Model	Model number
GP-3000 Series	GP3200A	AGP3200-A1-D24
	GP3200T	AGP3200-T1-D24
	GP3300L	AGP3300-L1-D24 AGP3300-L1-D24-D81K AGP3300-L1-D24-D81C AGP3300-L1-D24-FN1M
	GP3300S	AGP3300-S1-D24 AGP3300-S1-D24-D81K AGP3300-S1-D24-D81C
	GP3300T	AGP3300-T1-D24 AGP3300-T1-D24-D81K AGP3300-T1-D24-D81C AGP3300-T1-D24-FN1M
	GP3400S	AGP3400-S1-D24 AGP3400-S1-D24-D81K AGP3400-S1-D24-D81C
	GP3400T	AGP3400-T1-D24 AGP3400-T1-D24-D81K AGP3400-T1-D24-D81C AGP3400-T1-D24-FN1M
	GP3450T	AGP3450-T1-D24
	GP3500L	AGP3500-L1-D24 AGP3500-L1-D24-D81C
	GP3500S	AGP3500-S1-D24 AGP3500-S1-D24-D81K AGP3500-S1-D24-D81C AGP3500-S1-AF AGP3500-S1-AF-D81K AGP3500-S1-AF-D81C
	GP3500T	AGP3500-T1-D24 AGP3500-T1-D24-D81K AGP3500-T1-D24-D81C AGP3500-T1-D24-FN1M AGP3500-T1-AF AGP3500-T1-AF-D81K AGP3500-T1-AF-D81C AGP3500-T1-AF-FN1M
	GP3510T	AGP3510-T1-AF
	GP3550T	AGP3550-T1-AF
	GP3560T	AGP3560-T1-AF

Continued

Series	Model	Model number
GP-3000 Series	GP3600T	AGP3600-T1-AF
		AGP3600-T1-AF-D81K
		AGP3600-T1-AF-D81C
		AGP3600-T1-AF-FN1M
		AGP3600-T1-D24
		AGP3600-T1-D24-D81K
		AGP3600-T1-D24-D81C
		AGP3600-T1-D24-FN1M
		GP3650T
	GP3750T	AGP3750-T1-AF
AGP3750-T1-D24		
IPC series	WinGP	

■ **Supported Operating Systems**

Models supported by GP-Viewer EX are as follows.

Windows 2000 (Service Pack 3 or later)

Windows XP (Service Pack 2)

Windows Server 2003

■ **Target browser**

Internet Explorer 6.0

■ **Screen resolution**

Minimum 1024x768

■ Difference between GP-Viewer EX and Displays

Feature	Operation/Action	Supported/ Unsupported	Screen mode	GP-Viewer EX	Display	
Bit triggered Screen Capture	-	O	-	Does not work. Instead, from the toolbar use the [Screen Capture] button.	Runs normally.	
Bit triggered Backup Internal Device	-	O	-	Gets content backed up on the display unit so backups are synchronized.	Runs normally.	
Bit triggered save data to CF card	-	O	-	Touch the [Update Data in Storage] button to synchronize contents.	Runs normally.	
Bit triggered SRAM backup	-	O	-	Touch the [Screen Update] button to synchronize SRAM data.	Runs normally.	
Check CF Card free space	-	O	-	Touch the [Update Data in Storage] button to synchronize contents.	Runs normally.	
Check USB Storage free space	-	O	-	Touch the [Update Data in Storage] button to synchronize contents.	Runs normally.	
Alarm feature	History, log, active	O	-	Runs normally.	Runs normally.	
	Printing feature	X	-	Not supported.	Runs normally.	
	Groups	O	-	Runs normally.	Runs normally.	
	Sub-display	↕		Asynchronous	Synchronizes with the sub-display on the display unit.	Runs normally.
			O	Synchronous	Runs normally.	Runs normally.

Continued

Feature	Operation/Action	Supported/ Unsupported	Screen mode	GP-Viewer EX	Display
Special Switch (Alarm History Switch)	Clear, Clear All, Clear Recovered Alarm, Clear Acknowledged Alarm, Clear All Recovered Alarms, Clear All Acknowledged Alarms, Clear All Number of Occurrences Fields, Clear Individual Number of Occurrences Field, Clear All Accumulated Time Field, Clear Individual Accumulated Time Field	O	-	Unable to clear from GP-Viewer EX. When cleared on the display unit, touch the [Screen Update] button to synchronize data and also clear on GP-Viewer EX.	Runs normally.
Special Switch (Text Alarm Switch)	Confirmed	O	-	Unable to define from GP-Viewer EX. When defined on the display unit, touch the [Screen Update] button to synchronize data and also have defined on GP- Viewer EX.	Runs normally.
Alarm parts	Sub Display	↕	Asynchronous	Synchronizes with the sub-display on the display unit.	Runs normally.
		O	Synchronous	Runs normally.	Runs normally.
Text Alarm parts	Sub Display	↕	Asynchronous	Synchronizes with the sub-display on the display unit.	Runs normally.
		O	Synchronous	Runs normally.	Runs normally.
Recipe feature	Data Transmission	X	-	Not supported.	Runs normally.
	Filing	X	-	Not supported.	Runs normally.
	Show CSV	X	-	Not supported.	Runs normally.
	File Manager	X	-	Not supported.	Runs normally.

Continued

Feature	Operation/Action	Supported/ Unsupported	Screen mode	GP-Viewer EX	Display
Sampling	Collection, saving, total	O	-	[Screen Update] button synchronizes SRAM data with the [Update Cycle].	Runs normally.
Historical Trend Graph	-	O	-	Runs normally.	Runs normally.
Selector Switch	-	O	-	Runs normally.	Runs normally.
Lamp	-	O	-	Runs normally.	Runs normally.
Interlock	-	O	-	Runs normally.	Runs normally.
Bit Switch	-	O	-	Runs normally.	Runs normally.
Word Switch	-	O	-	Runs normally.	Runs normally.
Data Display	-	O	-	Runs normally.	Runs normally.
Graph	-	O	-	Runs normally.	Runs normally.
Data Block Display Graph	-	⚡	-	From the GP- Viewer EX [Block Graph] menu, the [Update], [Clear], and [Clear and Update] operations update all the channels.	Runs normally.
Sound	-	O	-	Runs normally.	Runs normally.
Message Display	-	O	-	Runs normally.	Runs normally.
Picture Display	-	O	-	Runs normally.	Runs normally.
Trigger Action		X	Asynchronous	Does not work.	Runs normally.
		⚡	Synchronous	Results of the drawing feature are not reflected in GP- Viewer EX.	Runs normally.
Text Table	-	O	-	Runs normally.	Runs normally.

Continued

Feature	Operation/Action	Supported/ Unsupported	Screen mode	GP-Viewer EX	Display
Script	D-Script	↕	Synchronous	Script runs, but results of the drawing feature are not reflected in GP-Viewer EX.	Runs normally.
		X	Asynchronous	Does not work.	Runs normally.
	Global D-Script	↕	Synchronous	Script runs, but results of the drawing feature are not reflected in GP-Viewer EX.	Runs normally.
		X	Asynchronous	Does not work.	Runs normally.
	Extended Script	↕	Synchronous	Script runs, but results of the drawing feature are not reflected in GP-Viewer EX.	Runs normally.
		X	Asynchronous	Does not work.	Runs normally.
2-color Backlight Switching	-	X	-	Not supported.	Runs normally if it is the target model.
Symbols and Variables	-	O	-	Runs normally.	Runs normally.
Start Time	-	↕	Synchronous	After starting up, and upon completion of communication with display units, begins the display.	Runs normally.
Standby Mode	[Screen OFF]	X	-	GP-Viewer EX does not turn the screen OFF.	Runs normally.
	Screen Change	X	-	GP-Viewer EX does not switch screens.	Runs normally.
Error display	-	O	-	Shows display unit errors. GP-Viewer EX errors are highlighted in red.	Runs normally.
System errors	-	O	-	GP-Viewer EX displays errors.	Runs normally.
Device monitor	-	X	Synchronous	Not supported.	Runs normally.
Remote PC Access	-	X	-	Not displayed.	Runs normally.
Movie Player	-	X	-	Not displayed.	Runs normally.
Movie Player Switch	-	X	-	Not displayed.	Runs normally.

Continued

Feature	Operation/Action	Supported/ Unsupported	Screen mode	GP-Viewer EX	Display
Video Module Display	-	X	-	Not displayed.	Runs normally.
Ladder Monitor (Logic)	-	X	-	Not supported.	Runs normally.
Ladder Monitor (Device/PLC)	-	X	-	Not supported.	Runs normally.
Logic Feature	-	X	-	Not supported.	Runs normally.
Japanese FEP keypad help	-	↕	-	Remembering inputs from GP- Viewer EX is available only when GP-Viewer EX is running and is cleared after restarting.	Runs normally.
Bar Code	-	X	-	Not supported.	Runs normally.
Printer	-	X	-	Not supported.	Runs normally.
File Manager parts	-	↕	-	References the local folder on the GP- Viewer EX computer. The file is updated when running the [Update Data in Storage] operation. Note: the Select Movie operation is not supported.	Runs normally.
Offline mode	-	X	-	Not supported.	Runs normally.

36.2.2 Development Process

The following describes the procedural flow of starting GP-Pro EX, creating a new screen, displaying screen data from a display unit on a computer, installing GP-Viewer EX for operation and operating GP-Viewer EX.

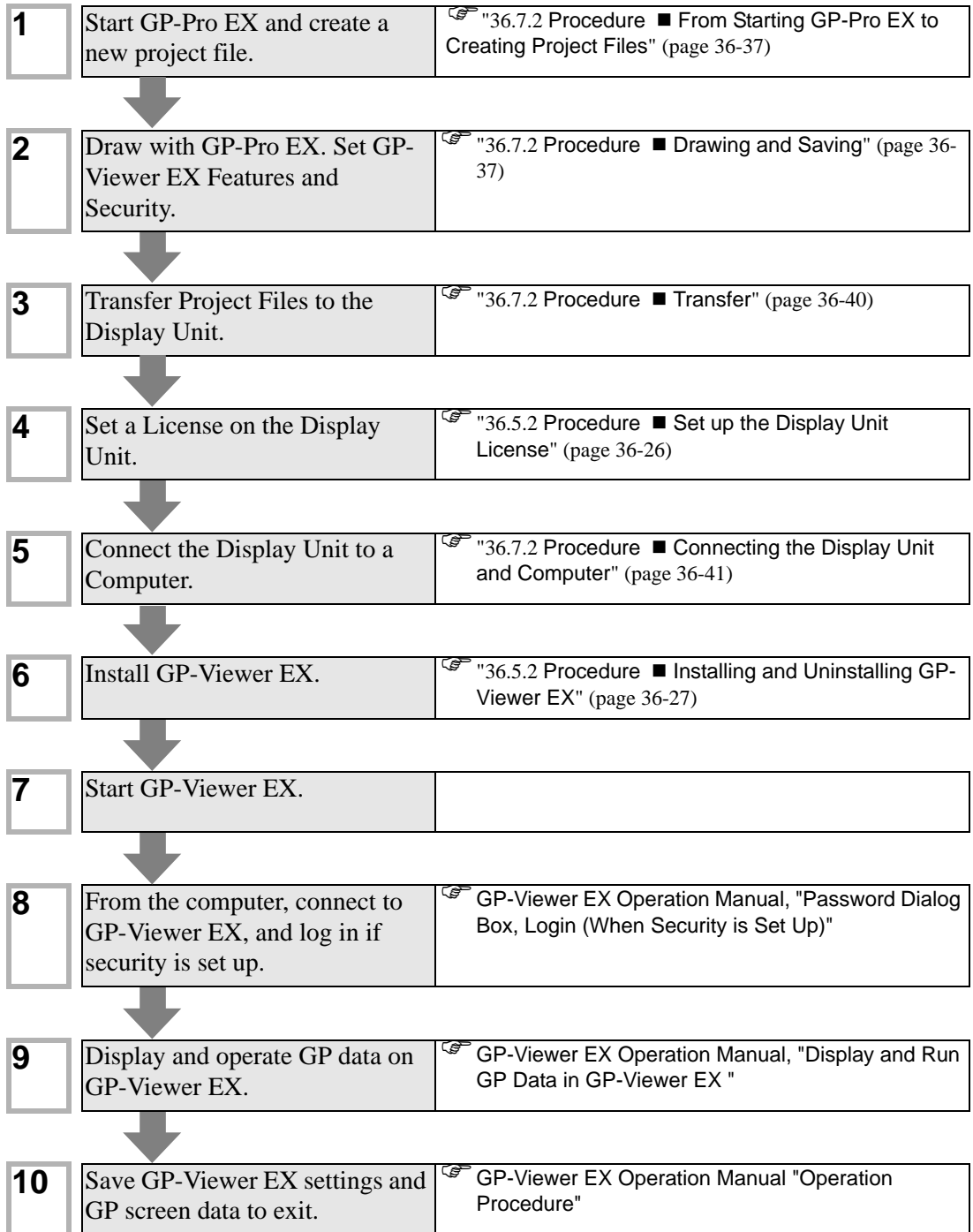

36.3 Web Server Operation Environment and Development Flow

36.3.1 Target models

The following lists the display unit models that support Web Server.

■ Display Units

Series	Model	Model number	
GP-3000 Series	GP3200A ^{*1}	AGP3200-A1-D24	
	GP3200T ^{*1}	AGP3200-T1-D24	
	GP3300L ^{*1}		AGP3300-L1-D24
			AGP3300-L1-D24-D81K
			AGP3300-L1-D24-D81C
			AGP3300-L1-D24-FN1M
	GP3300S ^{*1}		AGP3300-S1-D24
			AGP3300-S1-D24-D81K
			AGP3300-S1-D24-D81C
	GP3300T ^{*1}		AGP3300-T1-D24
			AGP3300-T1-D24-D81K
			AGP3300-T1-D24-D81C
			AGP3300-T1-D24-FN1M
	GP3400S		AGP3400-S1-D24
			AGP3400-S1-D24-D81K
			AGP3400-S1-D24-D81C
	GP3400T		AGP3400-T1-D24
			AGP3400-T1-D24-D81K
			AGP3400-T1-D24-D81C
			AGP3400-T1-D24-FN1M
	GP3450T		AGP3450-T1-D24
	GP3500L		AGP3500-L1-D24
			AGP3500-L1-D24-D81C
	GP3500S		AGP3500-S1-D24
			AGP3500-S1-D24-D81K
			AGP3500-S1-D24-D81C
			AGP3500-S1-AF
		AGP3500-S1-AF-D81K	
		AGP3500-S1-AF-D81C	

Continued

Series	Model	Model number
GP-3000 Series	GP3500T	AGP3500-T1-D24
		AGP3500-T1-D24-D81K
		AGP3500-T1-D24-D81C
		AGP3500-T1-D24-FN1M
		AGP3500-T1-AF
		AGP3500-T1-AF-D81K
		AGP3500-T1-AF-D81C
		AGP3500-T1-AF-FN1M
	GP3510T	AGP3510-T1-AF
	GP3550T	AGP3550-T1-AF
	GP3560T	AGP3560-T1-AF
	GP3600T	AGP3600-T1-AF
		AGP3600-T1-AF-D81K
		AGP3600-T1-AF-D81C
		AGP3600-T1-AF-FN1M
		AGP3600-T1-D24
		AGP3600-T1-D24-D81K
		AGP3600-T1-D24-D81C
		AGP3600-T1-D24-FN1M
	GP3650T	AGP3650-T1-AF
	GP3750T	AGP3750-T1-AF
		AGP3750-T1-D24

*1 When using the Web Server with GP-3200 and 3300 Series display units, 1 MB must be reserved in the User Screen Area. The Web Server adds 1 MB to the send data size.

■ Supported Operating Systems

The following lists operating systems that support the Web Server.
 Windows 2000 (Service Pack 3 or later)
 Windows XP (Service Pack 2)
 Windows Server 2003

■ Target browser

Internet Explorer 6.0

36.3.2 Supported Features

■ Features that Enable Display and Operations with Standard HTML Templates

- Log in to Web site
- Log off from Web site
- Device View
- When GP-Viewer EX is installed on the computer, start GP-Viewer EX
- Connect to the display unit's CF card or USB storage using the FTP server function to get files, delete files, change attributes, and write files
- Alarm display
- Alarm display (RSS data display)

36.3.3 Development Process

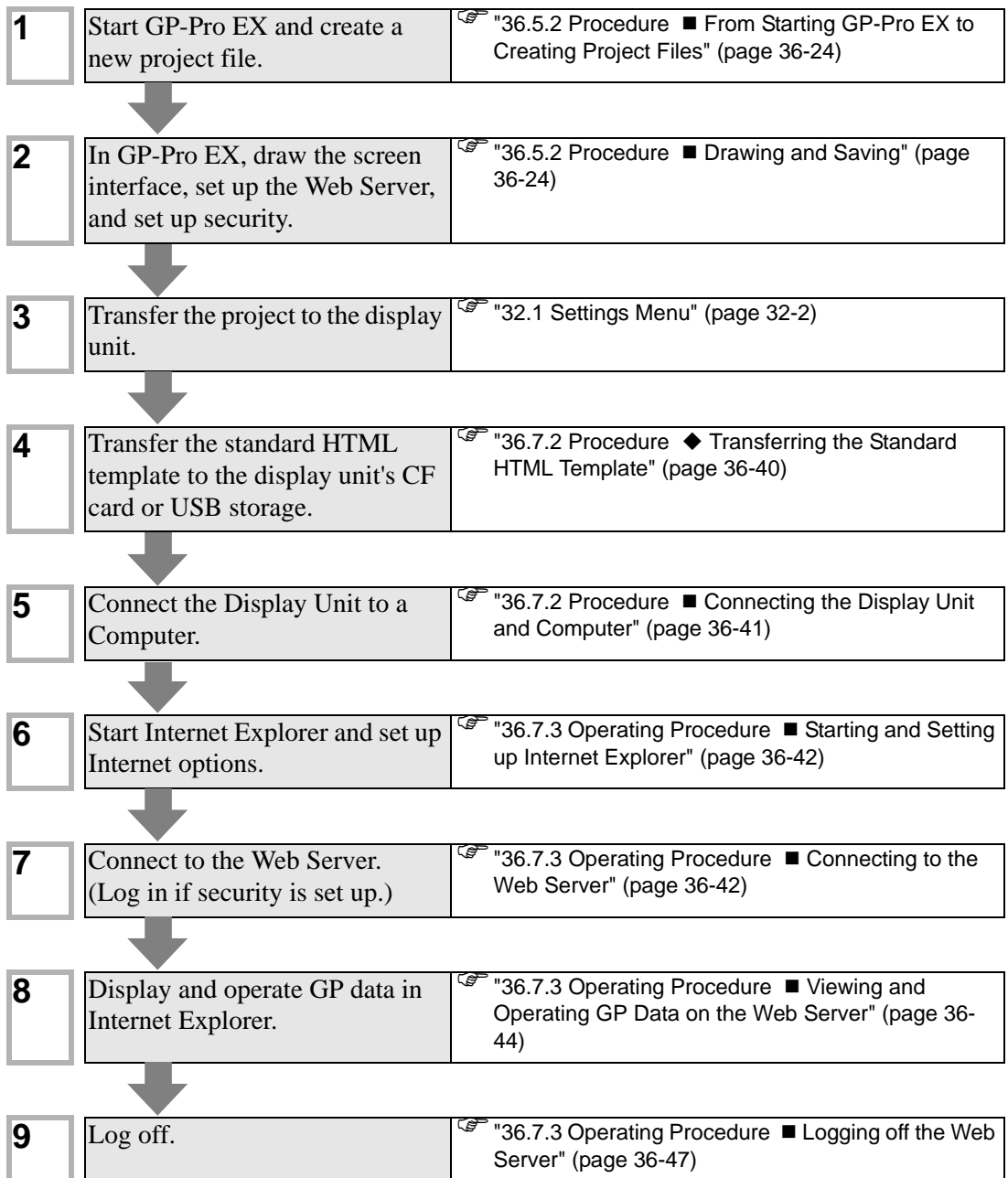

36.4 Settings Menu

Only some models can use the features introduced in this chapter. Check whether your model supports the features before changing any settings.

☞ "1.3 List of Supported Functions by Device" (page 1-5)

36.4.1 Setting Up GP-Viewer EX

Using GP-Viewer EX to Display and Operate with Data from Display Units

☞ "36.5.2 Procedure" (page 36-23)

☞ "36.5.1 Introduction" (page 36-22)

Restricting Access to GP-Viewer EX

☞ "36.6.2 Procedure" (page 36-31)

☞ "36.6.1 Introduction" (page 36-30)

36.4.2 Web Server Settings

Displaying Addresses on the Web Server and Changing Address Values

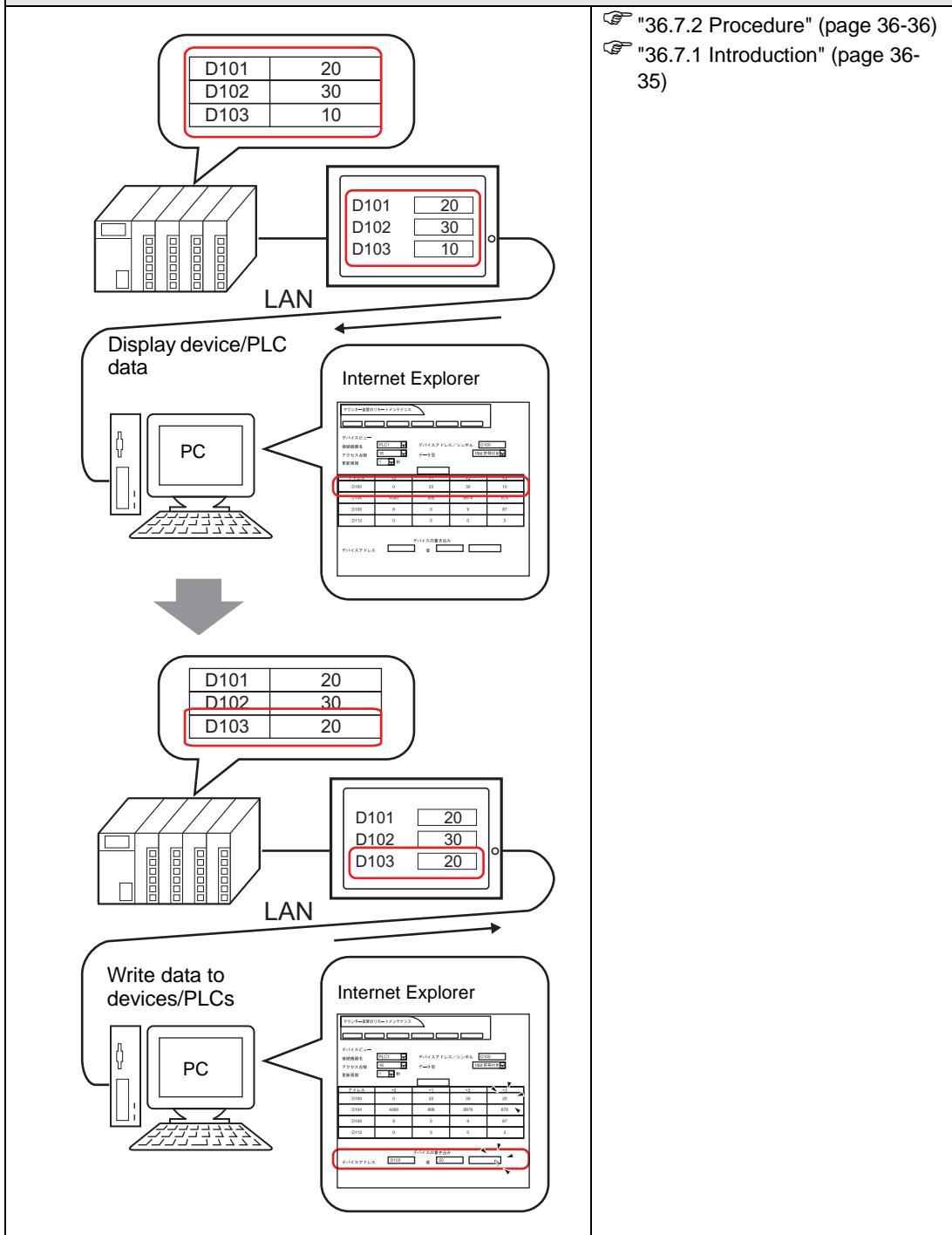

☞ "36.7.2 Procedure" (page 36-36)
 ☞ "36.7.1 Introduction" (page 36-35)

Displaying Alarm information on the Web Server

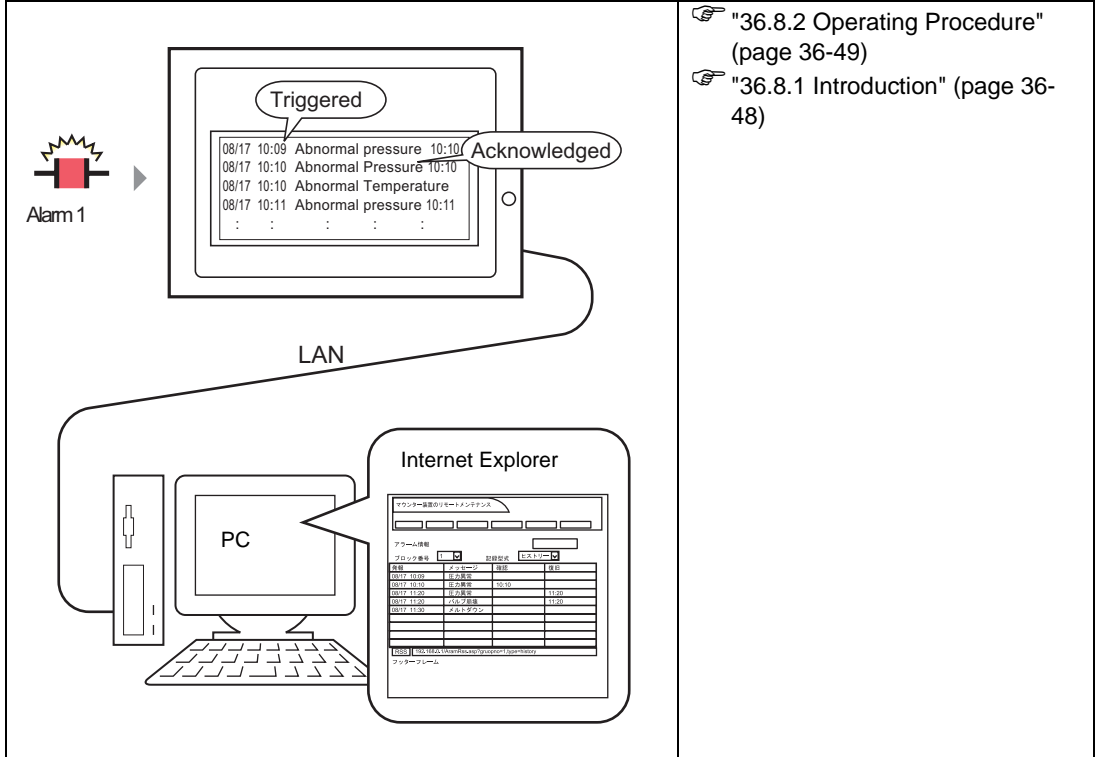

Displaying Alarm Information as RSS Data on the Web Server

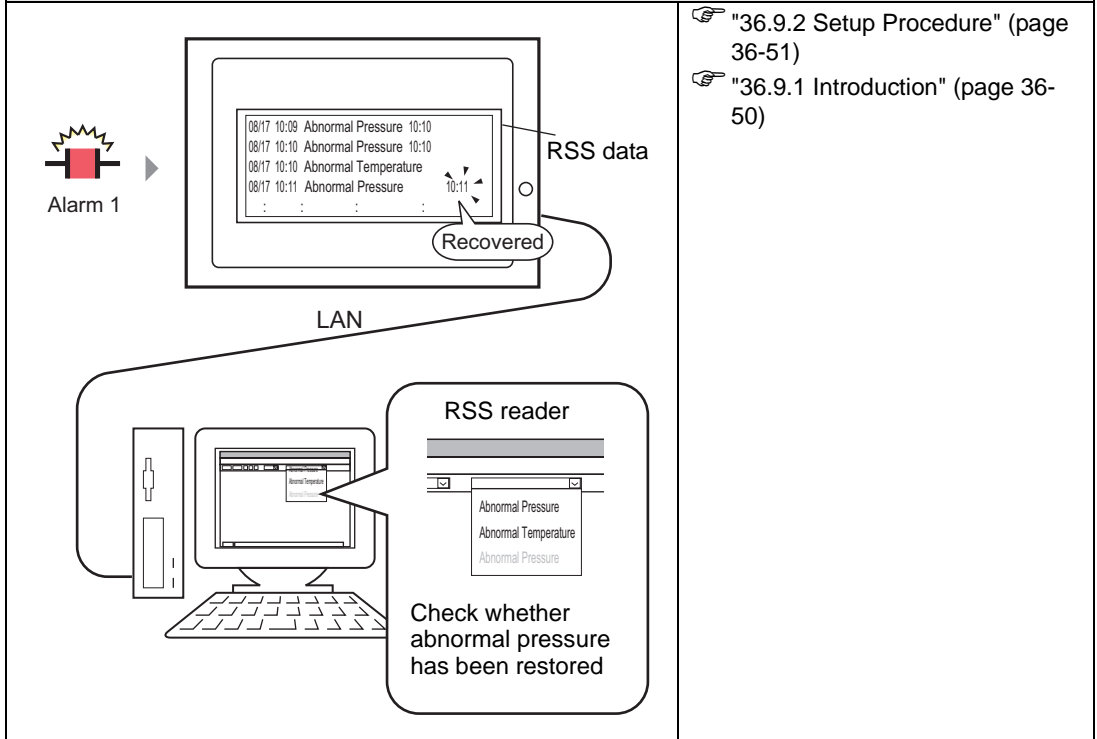

Using the Web Server to Transfer Files to the CF Card or USB Storage

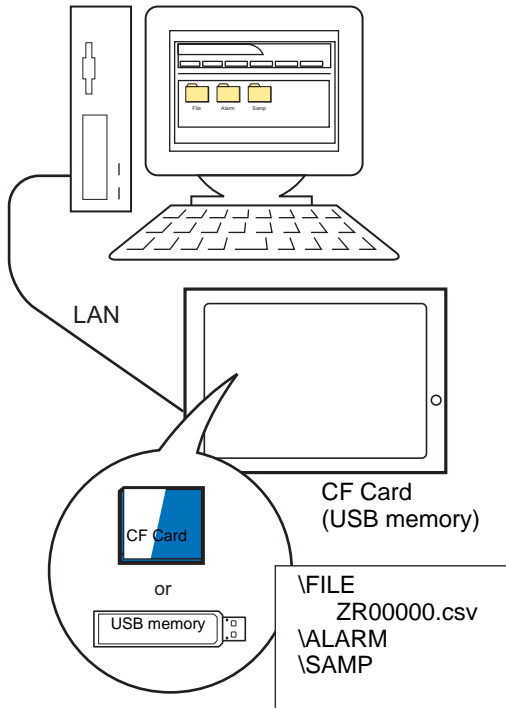

- ☞ "36.10.2 Setup Procedure" (page 36-54)
- ☞ "36.10.1 Introduction" (page 36-53)

Restricting Access to the Web Server

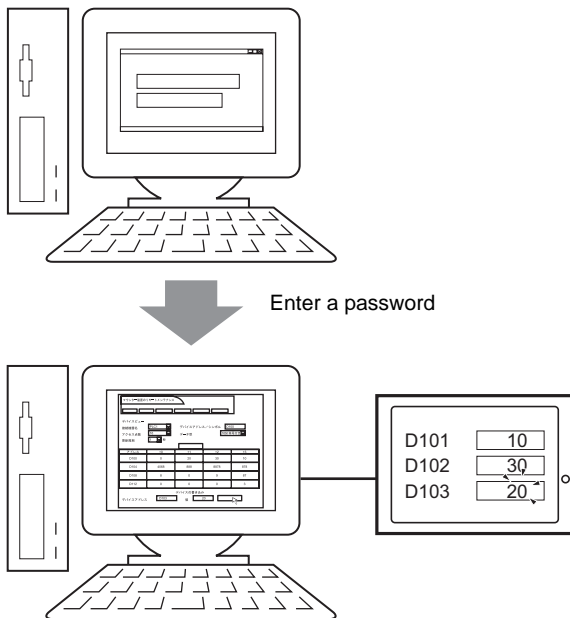

- ☞ "36.11.2 Setup Procedure" (page 36-61)
- ☞ "36.11.1 Introduction" (page 36-60)

36.5 Using GP-Viewer EX to Display and Operate with Data from Display Units

36.5.1 Introduction

By connecting the display unit (server), and the computer running GP-Viewer EX (client), you can use the computer to view screens on the display unit. Using this feature, you can check the displayed content and operate display units in remote locations. In the following example, you can acknowledge the alarm displayed on the GP.

IMPORTANT

- To use GP-Viewer EX, a separate license (Type: EX-VIEWER-LICENSE) is required for each display unit. Each display unit that uses GP-Viewer EX requires one key code. With a single key code, you can view the display unit screen on up to three instances of GP-Viewer EX.
- The key code cannot be reissued if you lose it. Please keep it at hand.
- For more information on key code input, see  Maintenance/Troubleshooting Guide, "Setting up GP-Viewer EX or Remote PC Access Licenses"

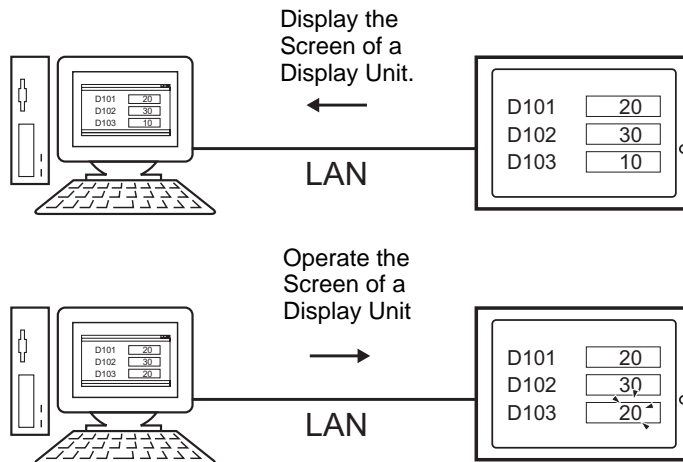

36.5.2 Procedure

NOTE

- Please refer to the settings guide for details.

☞ "36.12.2 System Settings [Display Unit] - [Remote Viewer] Settings Guide" (page 36-74)

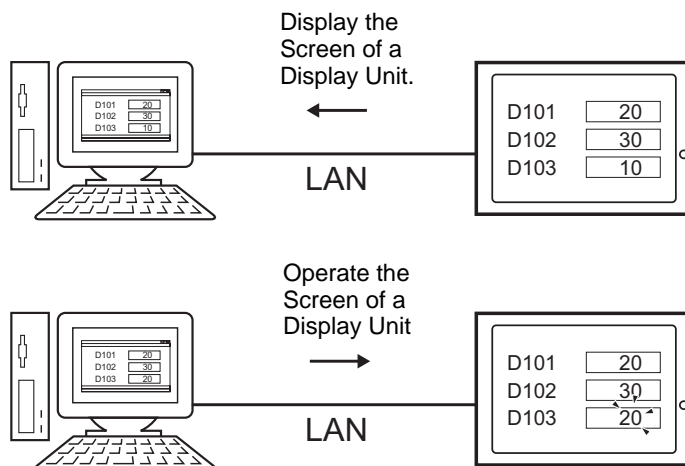

■ Necessary Device

- Display Unit. See "36.2.1 Target models ■ Display Units" (page 36-6) for supported models.
- GP-Pro EX (Ver.2.10 or later)
- GP-Viewer EX key code (Product sold separately. Model number: EX-VIEWER-LICENSE)
- Computer (For supported models, refer to "36.2.1 Target models ■ Supported Operating Systems" (page 36-7).)
- LAN cable and HUB (Commercial product)

■ Procedure Outline

- 1 Start GP-Pro EX and create a new project file.
- 2 In GP-Pro EX, draw the screen interface, set up GP-Viewer EX, and set up security.
- 3 Transfer the project to the display unit.
- 4 Set a License on the Display Unit.
- 5 Connect the Display Unit to a Computer.
- 6 Install GP-Viewer EX on the computer.
- 7 Start GP-Viewer EX.

■ From Starting GP-Pro EX to Creating Project Files

Start GP-Pro EX and create a new project file. The startup method is the same procedure as "5.2.2 Setup Procedure" (page 5-10) .

NOTE

- Please refer to the settings guide for details.
☞ "5.15.2 [New] Settings Guide" (page 5-89)
-

■ Drawing and Saving

◆ Drawing

Draws pictures. Refer to "5.2.2 Setup Procedure ■ Creating/Saving" (page 5-15)for the procedure for drawing. Turn to the corresponding section in accordance with the feature you want to use such as Alarm.

IMPORTANT

- There are differences in which features can be used in GP-Viewer EX. The following describes which features you can use in GP-Viewer EX.
☞ " ■ Difference between GP-Viewer EX and Displays" (page 36-8)
-

◆ GP-Viewer EX Features

In the System Settings workspace, click [Display Unit] and select the [Remote Viewer] tab. Select the [Enable Remote Viewer] check box to use GP-Viewer EX. Select the [Enable Screen Changes From Client] check box to run screen change operations on the display unit from a remote PC.

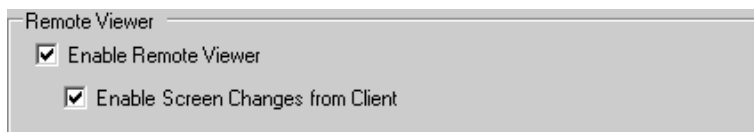

◆ **Security**

You can restrict access to GP-Viewer EX by adding security to display screens or individual features. In the following example, security is set up for screen data operations run from a computer. Level 1 users can display screen data, and Level 15 users can display and operate screen data.

- 1 In GP-Pro EX, from the [Common Settings (R)] menu point to [Security (Q)], and select [Security Password (P)], or click .

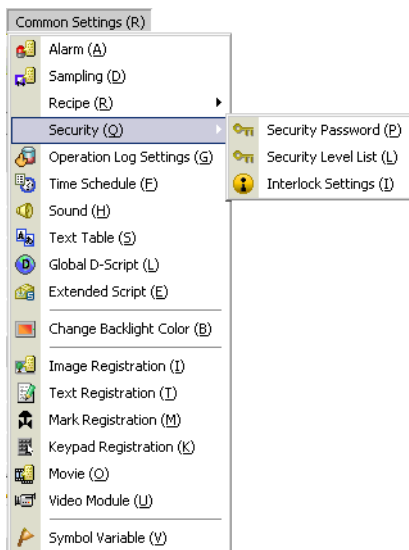

- 2 Password setting screen will open. Check [Enable Security Function] and input password "1111" in [Level 1] and password "5555" in [Level 15].

NOTE

- To set up user IDs for each level, see the following.
 "36.6.2 Procedure ■ User ID Mode" (page 36-33)

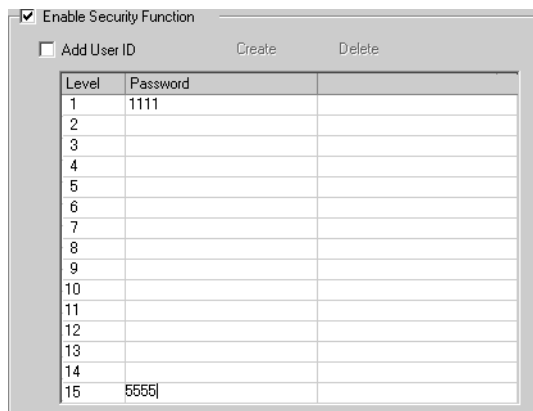

3 Next, when you select the [Set up Functions at Each Security Level] check box, you can define which functions are permitted at each security level. (Example, [Read GP-Viewer Data] = Level 1, [Read or Write GP-Viewer Data] = Level 15)

Set up Functions at Each Security Level

Item	Level
Offline Mode	0
Logic Monitor	0
Online Logic Editing	0
Read GP-Viewer Data	1
Read or Write GP-Viewer Data	15
View Web Server Contents	0

■ Transfer

Transfer Project Files to the Display Unit.

For the procedure for transferring project files, refer to the following.

☞ "32.1 Settings Menu" (page 32-2)

■ Set up the Display Unit License

On the display unit, go to offline mode, and then touch [Main Unit], [Extended Settings], and [GP-Viewer EX Key Code].

For details about how to set up the license, refer to the following.

☞ Maintenance/Troubleshooting Guide, "Setting up GP-Viewer EX or Remote PC Access License"

IMPORTANT

- To use GP-Viewer EX, a separate license (Type: EX-VIEWER-LICENSE) is required for each display unit. With a single key code, you can view the display unit screen on up to three instances of GP-Viewer EX.
- The key code cannot be reissued if you lose it. Please keep it at hand.
- When starting GP-Viewer EX without setting up the key code on the display unit, the trial version will start.

■ Connecting the Display Unit and Computer

Use the network HUB or Ethernet cable to connect the display unit to the computer.

IMPORTANT

- To communicate using Ethernet, Ethernet settings, such as the IP address and port number, must be set up on the GP.

NOTE

- Set up the display unit's IP address in Offline mode. Touch [Main Unit] and [Ethernet Setup]. For details on the setup procedure, refer to the following.
☞ Maintenance/Troubleshooting Guide, "Assigning an IP Address to the Display"
- 1:1 connections using a cross cable may not be possible depending on the type of PC and network card you are using. Make sure to use a HUB for Ethernet Communication.

■ Installing and Uninstalling GP-Viewer EX

◆ Install

Install GP-Viewer EX on the computer. You can use the installation CD, GP-Pro EX Ver.2.10 or later, or download the installer from the Pro-face Web site.

IMPORTANT

- GP-Viewer EX does not run if installed on an unsupported computer.
- Use a user account with administrator authority for installation.
- Exit all programs including virus check software.

- Installing from CD (GP-Pro EX Ver.2.10 or later)

1 Insert disk 2 of the GP-Pro EX installation CD into the CD drive.

2 In the GP-Pro EX set up screen, click [GP-Viewer EX].

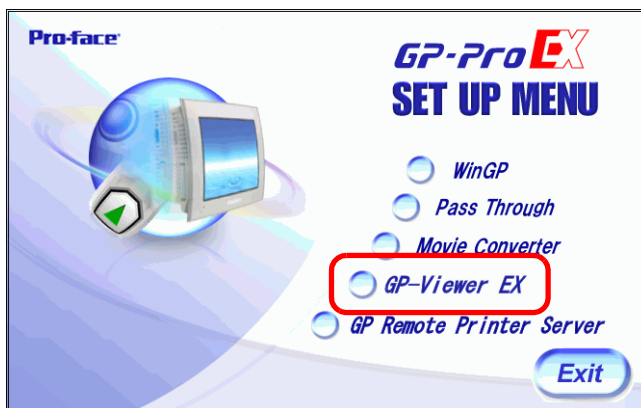

3 Follow the instructions in the installation wizard.

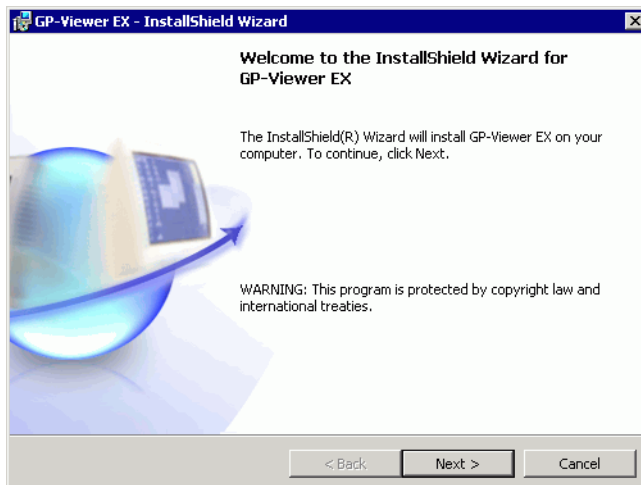

- 4 To specify the installation folder, in the next screen click [Change] and define a folder path with 80 single-byte characters or less.

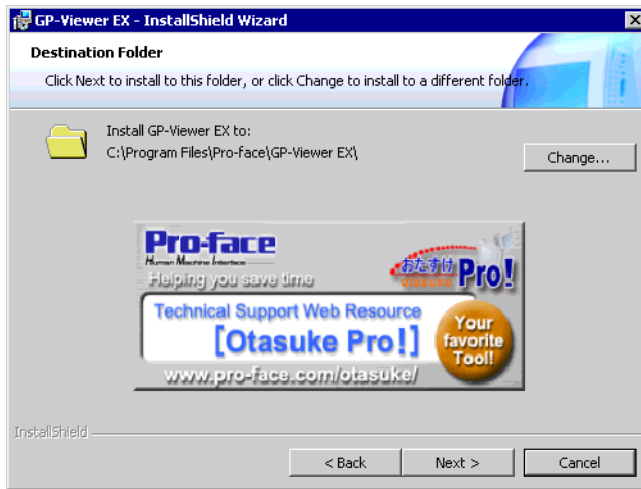

- 5 The following message appears. Click OK to complete the installation.

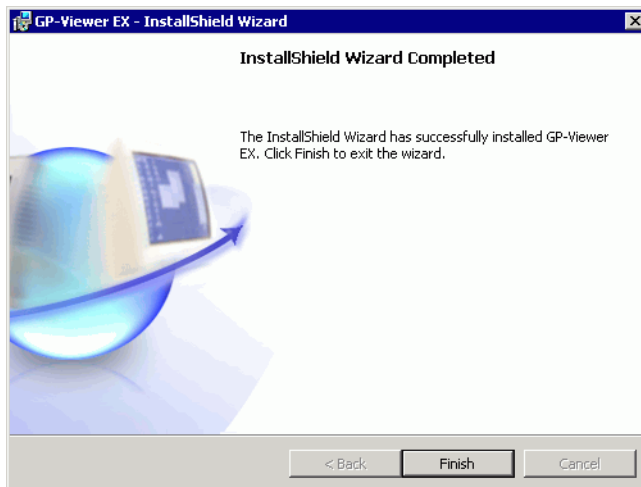

- Downloading and Installing from the Web site

NOTE

- The GP-Viewer EX installer can be downloaded from the Pro-face support site "Otasuke Pro!" (<http://www.pro-face.com/otasuke/>).
-

- 1 After downloading, double-click the file. In the confirmation message box click [RUN].
- 2 Follow the instructions in the installation wizard.

◆ Uninstall

Uninstall GP-Viewer EX from the computer.

Uninstall using Windows Control Panel, [Add/Remove Programs]

From the task bar, click [Start], point to [Settings] and then click [Control Panel]. In the [Control Panel], select [Add/Remove Programs]. In the list of installed applications, select [GP-Viewer EX] and click [Remove] to uninstall.

36.6 Restricting Access to GP-Viewer EX

36.6.1 Introduction

Set up security to place restrictions on which people can display and operate GP-Viewer EX to view and interact with data on the display unit. Set up security level 15 and password "5555" for maintenance staff. Set up security level 1 and password "1111" for status monitoring staff.

For the security settings, there are level mode settings and user ID mode settings.

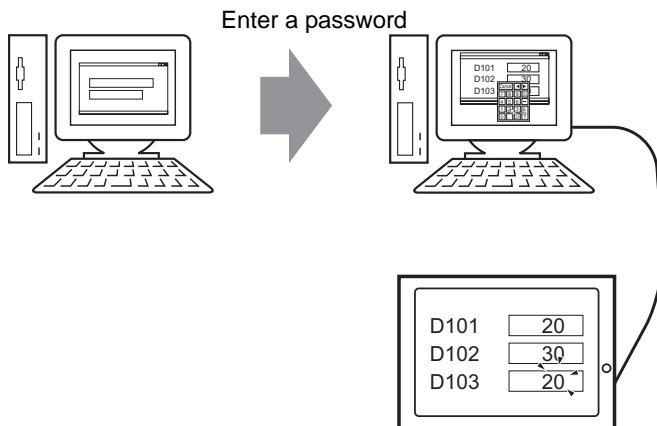

36.6.2 Procedure

NOTE

- Please refer to the settings guide for details.
 ☞ "21.7.1 Common (Security Settings) Settings Guide" (page 21-19)

Set up security level 15 and password "5555" for maintenance staff. Set up security level 1 and password "1111" for status monitoring staff.

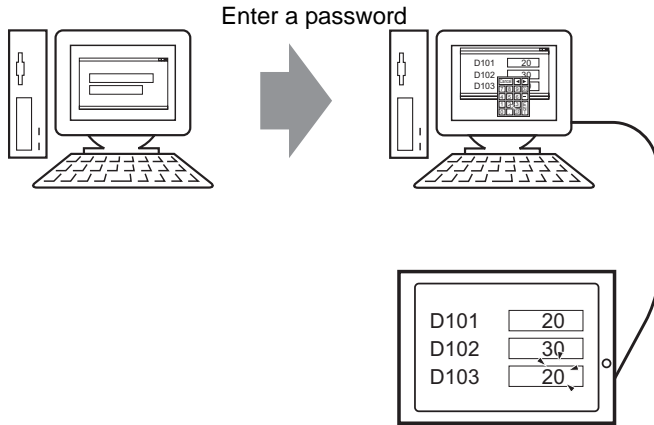

NOTE

- Security level 0 means no security is set.

■ Level Mode

Registers passwords for security levels 1 to 15 and defines the security level for each display screen.

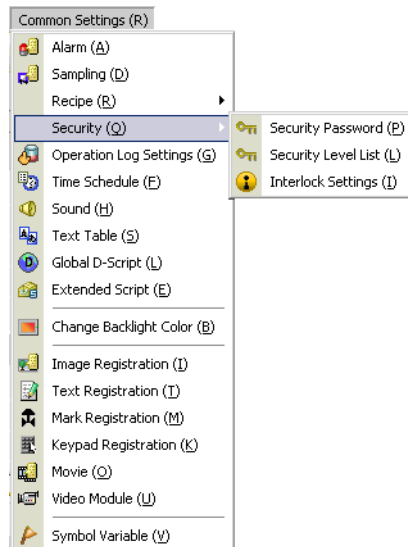
- 1 From the [Common Settings (R)] menu, point to [Security (Q)] and select [Security Password] or click  on the toolbar.



2 In the Passwords screen, select the [Enable Security Function] check box and type password "1111" for [Level 01] and "5555" for [Level 15].

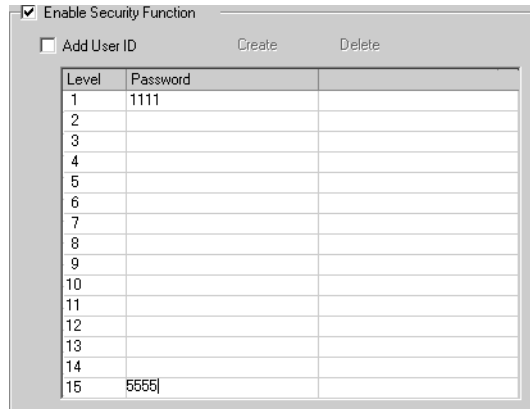

NOTE

- Each password should be 8 single-byte characters or less.

3 Next, select the [Set up Functions at Each Security Level] check box and define the security level for each [Item]. (Example, [Read GP-Viewer Data] = Level "1", [Read or Write GP-Viewer Data] = Level "15")

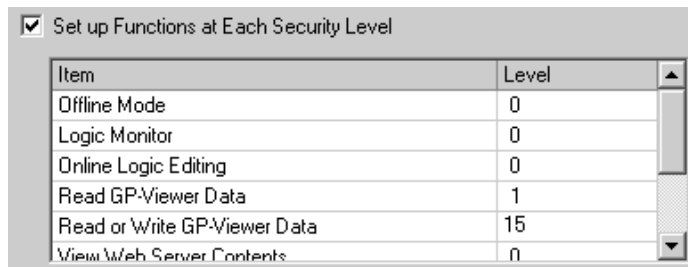

4 From the [Common Settings (R)] menu, point to [Security (Q)] and select [Security Level List (L)].

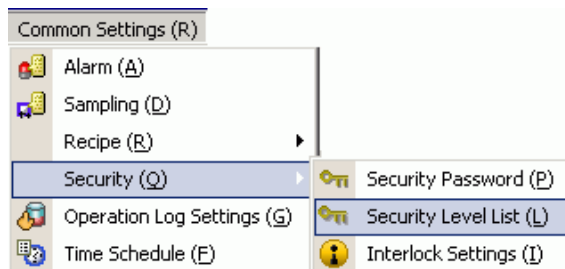

5 For the monitor screen (Screen: B1) set a [Security Level] of 1, and for the maintenance screen (Screen: B2) set a [Security Level] of 15.

Screen ▲	Security Level	Title
B1	1	Monitor Screen
B2	15	Maintenance Screen

- NOTE**
- After setting up security levels, transfer the project to the display unit.
 - Refer to the following for information on security operations in GP-Viewer EX.
 GP-Viewer EX Operation Manual, "Displaying and Operating Display Unit Data from GP-Viewer EX"

■ User ID Mode

Register user IDs and passwords for each security level, then the security level for each display screen.

1 From the [Common Settings (R)] menu, point to [Security (Q)] and select [Security Password] or click  on the toolbar.

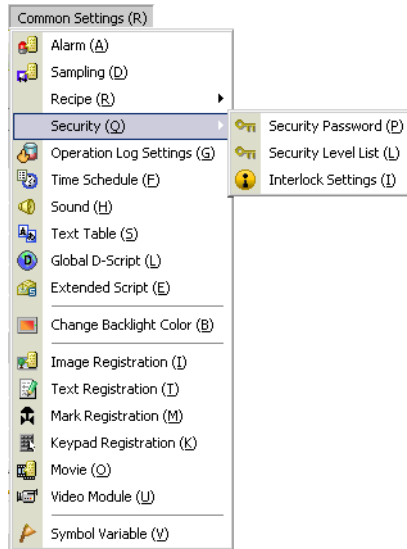

2 In the Set Password screen, select the [Enable Security Function] and [Add User ID] check boxes. Click [Create] to add one set of settings: Security Level, User ID, and Password.

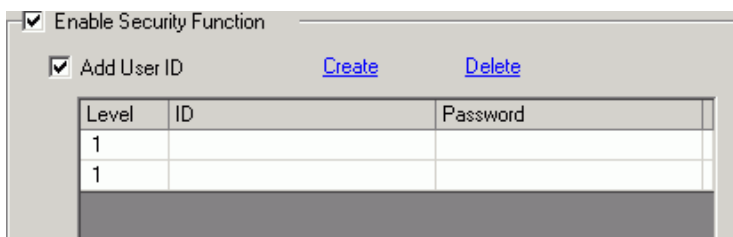

- 3 Set the security level, user ID, and password for status monitoring and maintenance staff.
 (Example: Status Monitoring: [Level] = "1", [Password] = "1111", [ID] = "Monitor";
 Maintenance: [Level] = "15", [Password] = "5555", [ID] = "Admin")

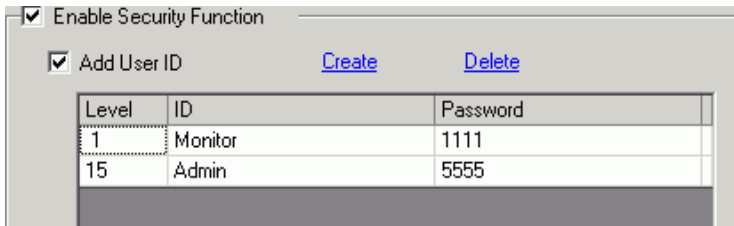

NOTE • Each password should be 8 single-byte characters or less.

- 4 Next, select the [Set up Functions at Each Security Level] check box and define the security level for each [Item]. (Example, [Read GP-Viewer Data] = Level "1", [Read or Write GP-Viewer Data] = Level "15")

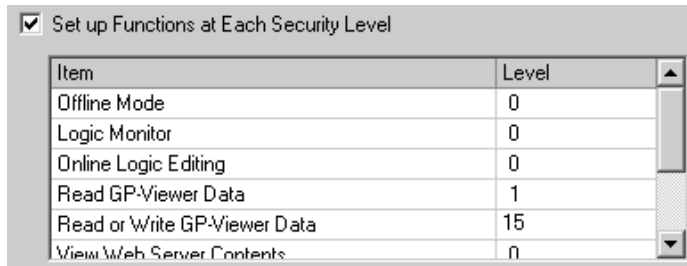

NOTE

- When defining [Read GP-Viewer Data], first set up the level for [Read or Write GP-Viewer Data].
- After setting up security levels, transfer the project to the display unit.
- Refer to the following for information on security operations in GP-Viewer EX.
 GP-Viewer EX Operation Manual, "Displaying and Operating Display Unit Data from GP-Viewer EX"

IMPORTANT

- When security is not set up for [Read GP-Viewer Data], the security level is reset to 0 if an incorrect password is entered in the [Switch User ID] or [Change Security Level] dialog box.

36.7 Displaying Addresses on the Web Server and Changing Address Values

36.7.1 Introduction

Using the Web Server feature, you can use Internet Explorer to display and change device address values of networked GPs and connected devices/PLCs.

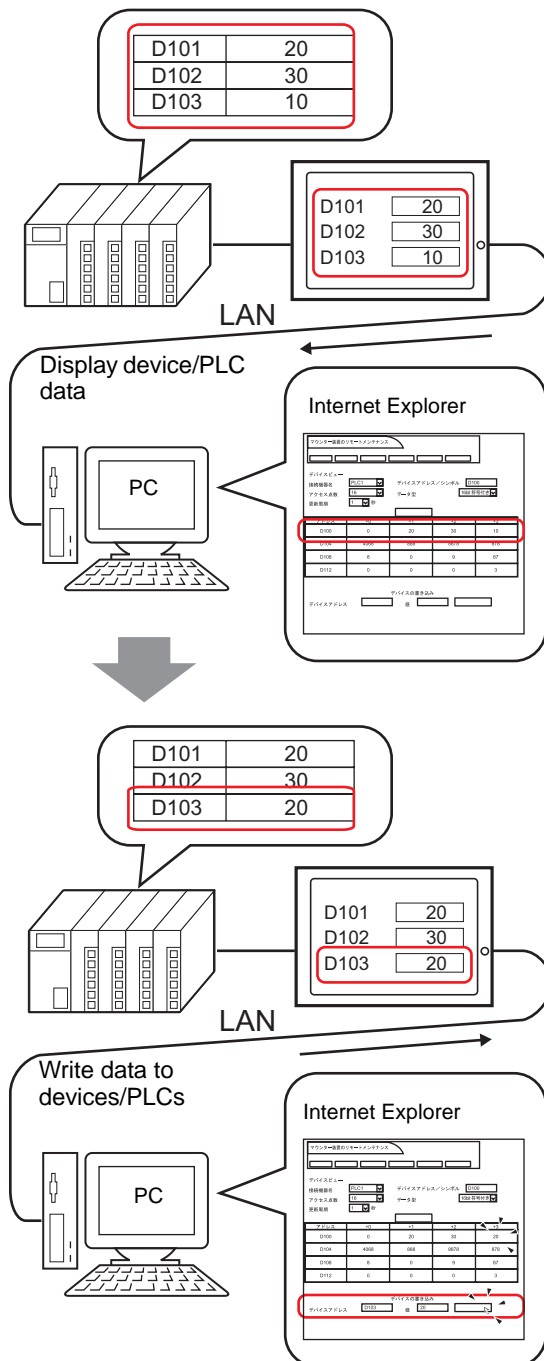

36.7.2 Procedure

NOTE

- Please refer to the settings guide for details.
- ☞ "36.12.1 Standard Template HTML Setting Guide" (page 36-67)
- ☞ "36.12.2 System Settings [Display Unit] - [Remote Viewer] Settings Guide" (page 36-74)

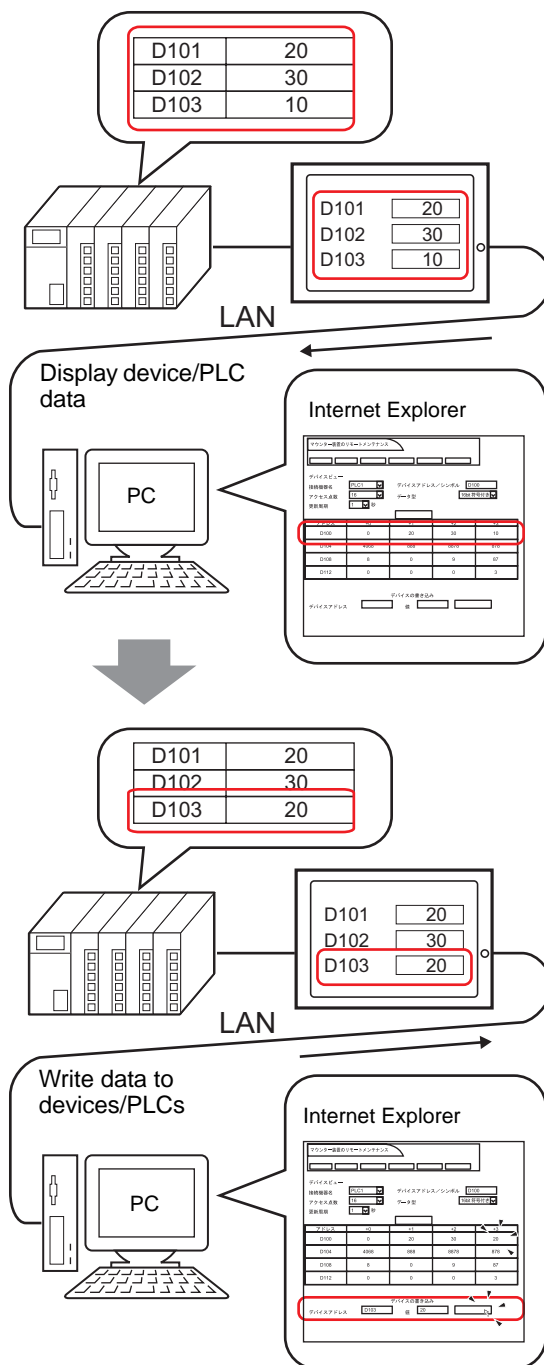

■ Necessary Device

- 1 Display Unit. (See "36.3.1 Target models ■ Display Units" (page 36-14) for supported models.)
- 2 GP-Pro EX (Ver2.10 or later)
- 3 Computer (For supported models, refer to "36.3.1 Target models ■ Supported Operating Systems" (page 36-15).)
- 4 LAN cable and HUB (Commercial product)

■ Procedure Outline

- 1 Start GP-Pro EX and create a new project file.
- 2 In GP-Pro EX, draw the screen interface, set up the Web Server, and set up security.
- 3 Transfer the project to the display unit.
- 4 Transfer the standard HTML template to the display unit.
- 5 Connect the Display Unit to a Computer.
- 6 Start Internet Explorer and set up Internet options.

■ From Starting GP-Pro EX to Creating Project Files

Start GP-Pro EX to create a new project file. The startup method is the same procedure as "5.2.2 Setup Procedure" (page 5-10) .

NOTE

- Please refer to the settings guide for details.
☞ "5.15.2 [New] Settings Guide" (page 5-89)
-

■ Drawing and Saving

◆ Drawing

In GP-Pro EX, draw the screen interface. For drawing methods, refer to "5.2.2 Setup Procedure ■ Creating/Saving" (page 5-15). You can also refer to chapters related to particular features, such as alarms.

IMPORTANT

- There are differences in which features can be used in the Web Server. The following describes which features you can use in Web Server.
☞ "1.3 List of Supported Functions by Device" (page 1-5)
-

◆ **Web Server Features**

In the System Settings workspace, click [Display Unit] and select the [Remote Viewer] tab. In the [Web Server] area, select the [Enable Web Server] check box. For the [Destination], define where to transfer the standard HTML template required by the Web Server, and define the destination [Folder]. (Example, [Destination] = CF Card, [Folder] = "WebSite", [Default page when there is no file] = "default.html", [HTTP Port Number] = "80")

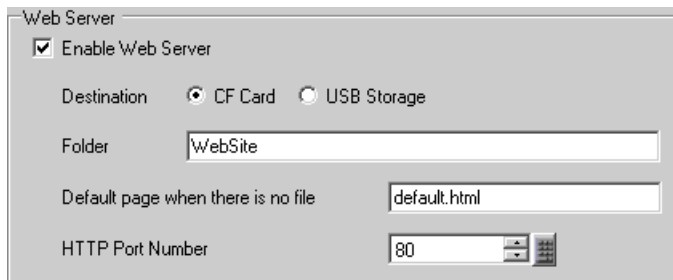

◆ **Security**

Set up security to place restrictions on which people can display and operate Web Server to display and interact with data on the display unit. Set up security level 15 and password "5555" for maintenance staff. Set up security level 1 and password "1111" for status monitoring staff.

NOTE

- You can use the Web Server without setting up any security.

1 In GP-Pro EX, from the [Common Settings (R)] menu point to [Security (Q)], and select [Security Password (P)], or click .

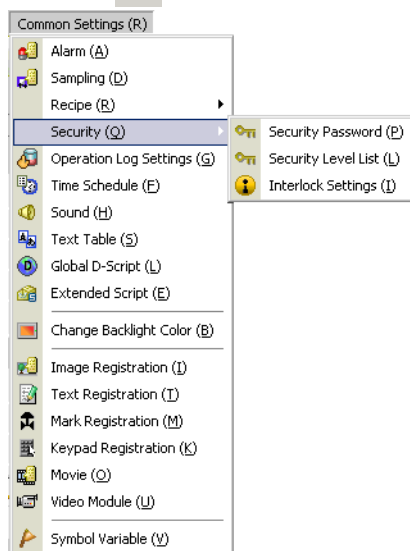

2 Password setting screen will open. Check [Enable Security Function] and input password "1111" in [Level 1] and password "5555" in [Level 15].

NOTE

- To set up user IDs for each level, see the following.
 " ■ User ID Mode" (page 36-64)

Enable Security Function

Add User ID Create Delete

Level	Password	
1	1111	
2		
3		
4		
5		
6		
7		
8		
9		
10		
11		
12		
13		
14		
15	5555	

3 Next, when you select the [Set up Functions at Each Security Level] check box, you can define which functions are permitted at each security level.
 (Example, [Read Web Server Data] = Level 1, [Read or Write Web Server Data] = Level 15)

Set up Functions at Each Security Level

Item	Level
Read GP-Viewer Data	0
Read or Write GP-Viewer Data	0
View Web Server Contents	0
Read Web Server Data	1
Read or Write Web Server Data	15
Review files in FTP folder	0

■ **Transfer**

◆ **Transfer Project File**

Transfer Project Files to the Display Unit.

For the procedure for transferring project files, refer to the following.

☞ "32.1 Settings Menu" (page 32-2)

◆ **Transferring the Standard HTML Template**

- 1 On the GP-Pro EX state tool bar, click the Transfer Project icon to activate [Transfer Tool].

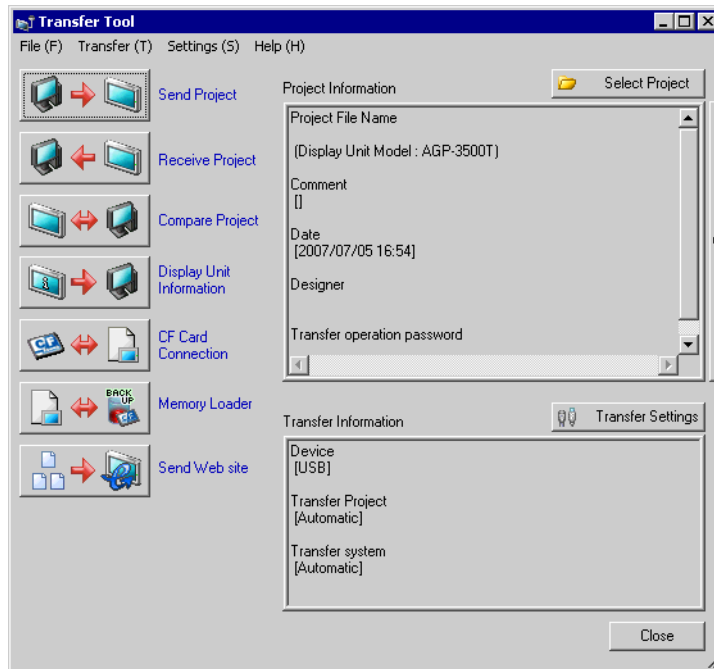

- 2 Click [Send Web site] to display the following dialog box. In the [Transfer From] field, identify the location of the standard HTML template. Click [OK] to start transfer.

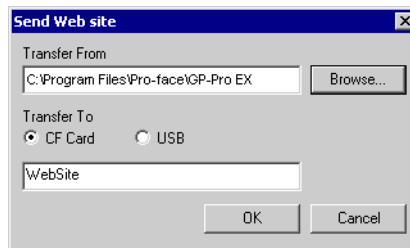

NOTE

- To use the Web Server, be sure to transfer the standard HTML template to the display unit. The standard HTML template is installed in C:\Program Files\Pro-face\GP-Pro EX 2.1\HTMLContent. For transfer methods, refer to the following.
 - ☞ "32.10 Setting Up Transfer Tool" (page 32-56)
 - The system program on the display unit (Runtime) must be GP-Pro EX Ver2.10 or later, or you cannot transfer the standard HTML template to the display unit.
-

3 When transfer is completed, the state of the dialog box changes from [Transferring] to [Transfer Complete]. Click [Close] to close the dialog box.

■ Connecting the Display Unit and Computer

Use the network HUB or Ethernet cable to connect the display unit to the computer.

IMPORTANT

- To communicate using Ethernet, Ethernet settings, such as the IP address and port number, must be set up on the GP.
-

NOTE

- Set up the display unit's IP address in Offline mode. Touch [Main Unit] and [Ethernet Setup]. For details on the setup procedure, refer to the following.
 - ☞ Maintenance/Troubleshooting Guide, "Assigning an IP Address to the Display"
 - 1:1 connections using a cross cable may not be possible depending on the type of PC and network card you are using. Make sure to use a HUB for Ethernet Communication.
-

36.7.3 Operating Procedure

■ Starting and Setting up Internet Explorer

- 1 Start Internet Explorer.

- 2 From the [Tools] menu, select [Internet Options]. In the [Internet Options] dialog box, click the [Advanced] tab to set up the following items.
 - (1) Select [Enable FTP folder view (outside of Internet Explorer)].
 - (2) Clear [Show friendly HTTP error messages].
 - (3) Select [Use Passive FTP (for firewall and DSL modem compatibility)].

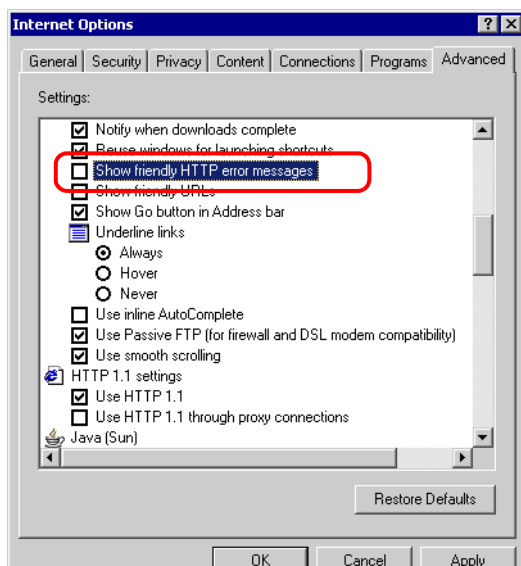

■ Connecting to the Web Server

- 1 Start Internet Explorer, and in the Address bar enter the IP address of the display unit. (Example, 192.168.0.1)



- 2 Press the Enter key to connect to the display unit's Web Server. If security is set up, the [Input Network Password] dialog box appears. Enter the password, which can be up to 8 single-byte characters long, and click [OK].

(Example, "5555" (Security level that enables viewing and operating GP data))

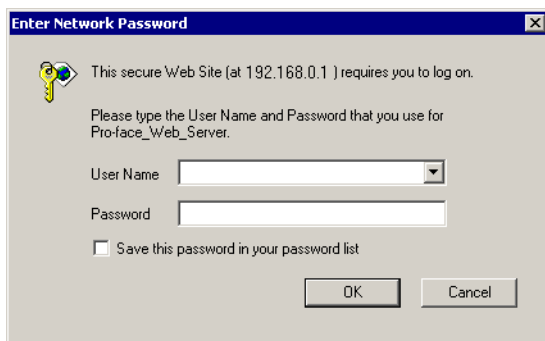

NOTE

- When the [User ID] is set up in the security settings, the [User Name] also needs to be inputted.
- If security is set up and you exit Internet Explorer, the next time you reconnect, even if you type the URL to connect directly to the Web Server, you need to input the password again.

- 3 When you connect to the display unit's Web Server, the following [Welcome] screen appears.

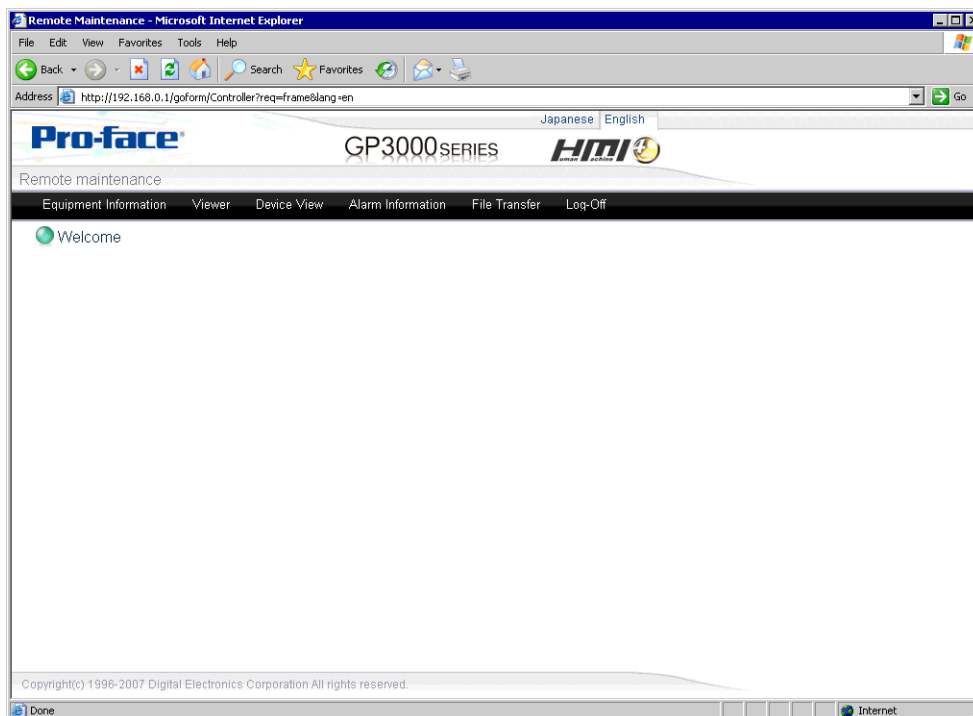

■ Viewing and Operating GP Data on the Web Server

- 1 From the HTML menu, select [Device View].
- 2 In the [Device View] screen, define the range of device addresses to display and the update rate. Define the [Device/PLC Name], [Device Address], [Access Points], [Data Type], and also the monitoring frequency in the [Update Frequency] field. Select [Start Monitoring] to begin.
(Example, [Device/PLC Name] = PLC1, [Device Address] = D101, [Access Points] = 4, [Data Type] = 16 bits Signed, [Update Frequency] = 60

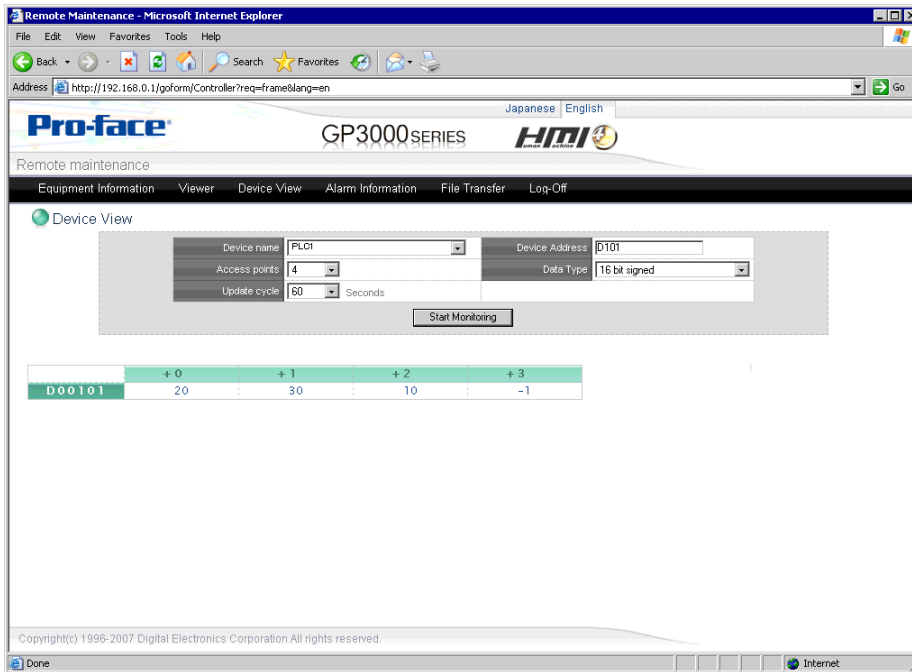

- 3 Click a value to display the [Device View Write] dialog box, and enter a new value in the [Value] field. Click [Write] to set the value to the device/PLC connected to the GP. (Example, [Device Address] = D103, [Value] = 20)

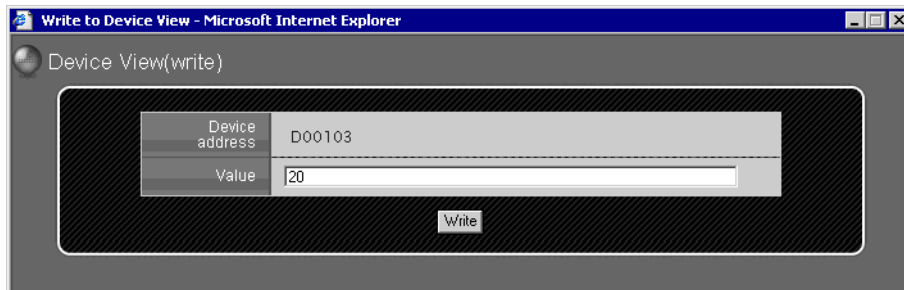

IMPORTANT

- When displaying a Web page in Windows XP Service Pack 2, because the default setting blocks popup windows, make sure you allow popups so you can view the Web page and enter values on the Web Server. The following describes the steps to allow popups.

<Allowing Popup Windows From a Specific URL>

In Internet Explorer, from the [Tools] menu point to [Pop-up Blocker] and select [Pop-up Blocker Settings].

In the [Address of Web site to allow] field, type the URL and then click [Add].

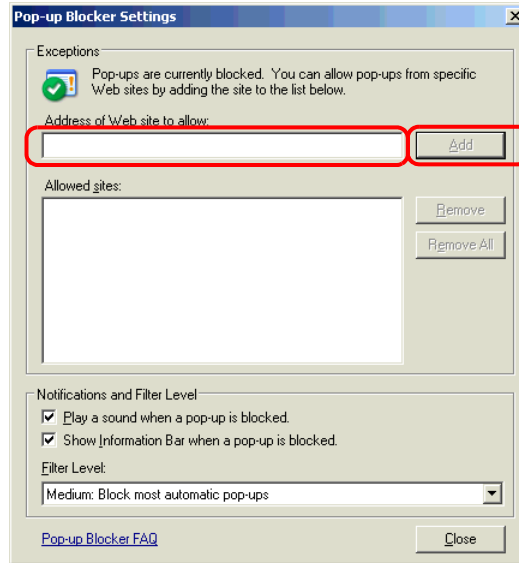

<Temporarily Allow Popups>

Click the information bar and select [Temporarily Allow Popups] to display the blocked window.

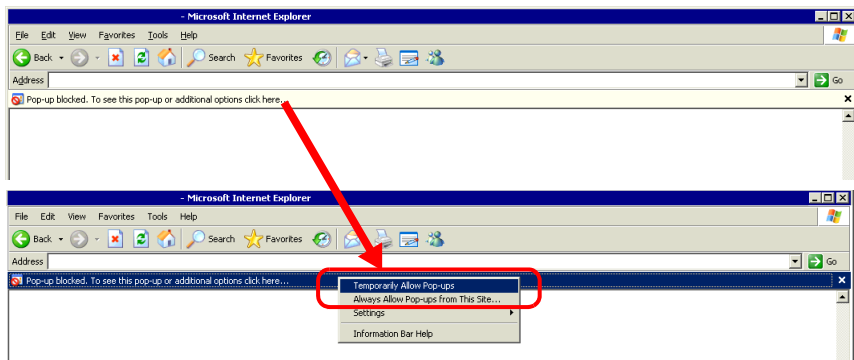

NOTE

- You can input multiple values at one time. In the [Value] field, input multiple values separated with either spaces or commas. Select [Write] to write the values to consecutive addresses from the defined address. Note, the number of consecutive addresses you can write to depends on the [Data Type], as follows.

Data Type	Input Points
Bit	128 points
16 Bit Signed	36 points
16 Bit Unsigned	42 points
16 Bit Hexadecimal	51 points
32 Bit Signed	21 points
32 Bit Unsigned	23 points
32 Bit Hexadecimal	28 points
Single-precision floating point	28 points
Double-precision floating point	14 points
Text	256 bytes

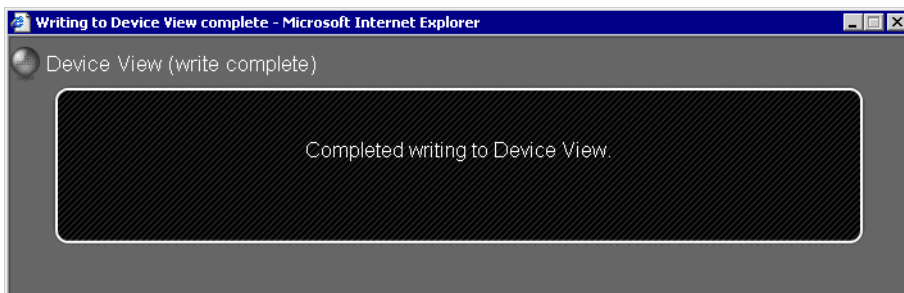

■ Logging off the Web Server

- 1 When you have completed viewing and operating the GP, log off from the Web Server. From the menu, select [Log off] to display the following dialog box. Click [OK].



- 2 When the following dialog box appears, select [Yes].

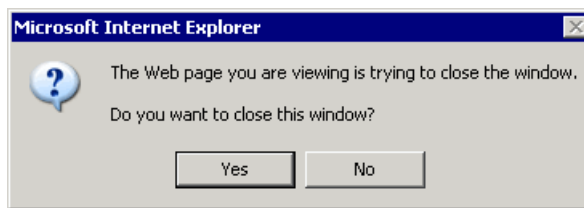

- 3 Close Internet Explorer to complete the log off process.

36.8 Displaying Alarm information on the Web Server

36.8.1 Introduction

In Internet Explorer, use the [Refresh] command to display the latest alarm information generated on the remote GP.

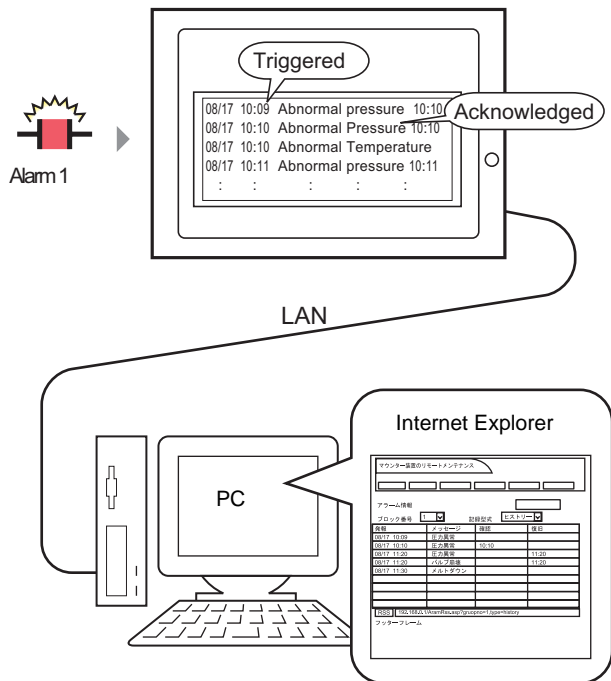

NOTE

- Nothing displays when there is no alarm information on the GP. For steps on displaying an alarm, see the following.
 "Chapter 19 Alarm" (page 19-1)

36.8.2 Operating Procedure

1 Log in to the Web Server and select [Alarm Information] in the [Welcome] screen.

NOTE

- For information on setting up and connecting to the Web Server, see the following.
 "36.7 Displaying Addresses on the Web Server and Changing Address Values" (page 36-35)

2 When the following screen appears, in the [Block Number] field select the alarm block number to display, and in the [Record Format] field select the alarm display mode. The [Refresh] command lists the current alarm information as follows (example, [Block Number] = Block 1, [Record Format] = History).

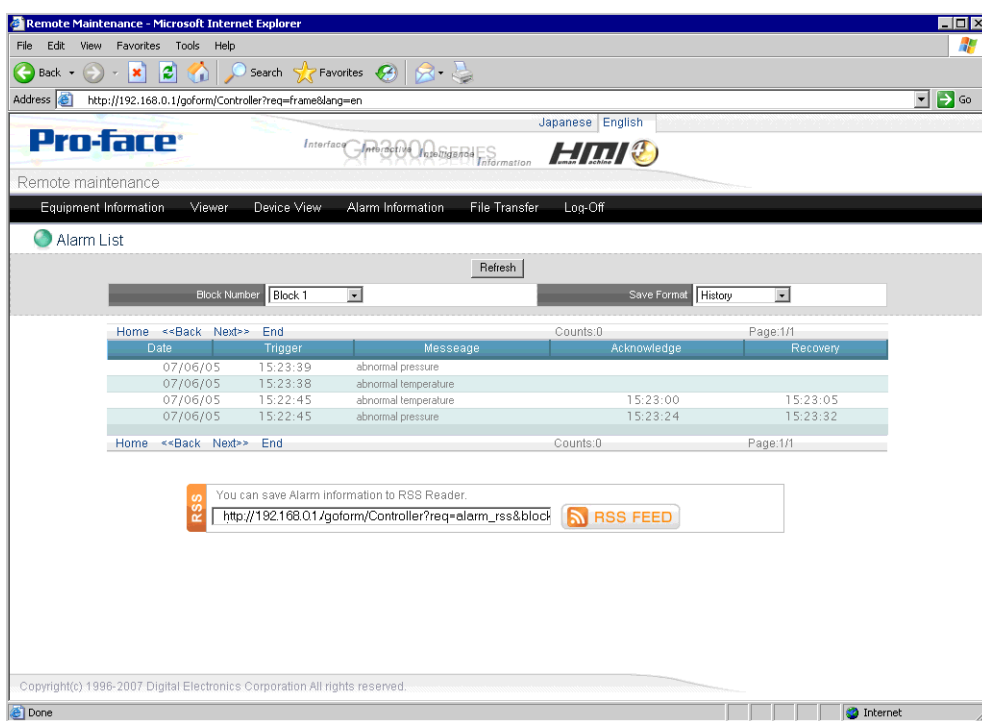

NOTE

- Select the [Refresh] command again to get the latest alarm information.

3 When you complete reviewing the alarm information, [Log off] to disconnect.

36.9 Displaying Alarm Information as RSS Data on the Web Server

36.9.1 Introduction

Displays alarm information accumulated from the remote GP as Internet RSS data. As an example, the following describes the setup procedure for displaying alarm information in a RSS bar which is updated just like the browser's Refresh command.

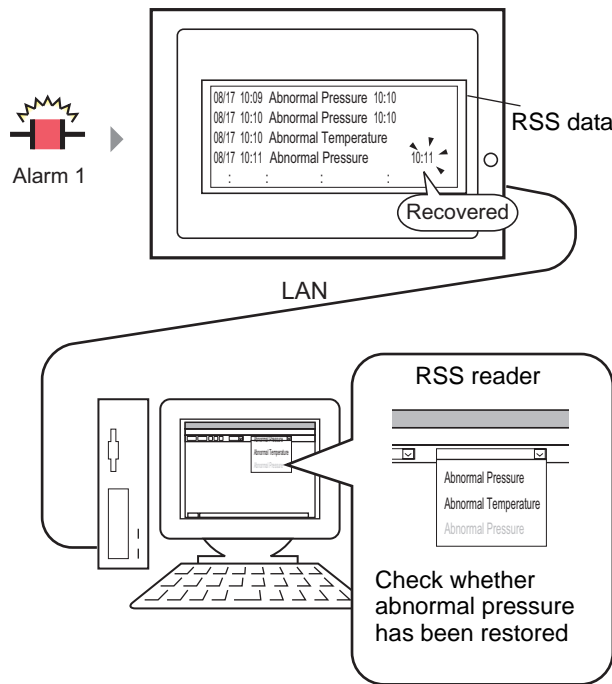

■ Rich Site Summary (RSS) Data

A format for describing HTML data such as the Web site title or site map, RSS is mainly used for disclosing site update information.

Using RSS data increases efficiency as it allows you to check updated information in a consistent format.

To display RSS data, you need to install an RSS reader application. Display methods are different from one RSS reader application to another. Check the Pro-face support site "Otasuke Pro!" (<http://www.pro-face.com/otasuke/>) for RSS readers that have been confirmed to work with GP-Pro EX.

36.9.2 Setup Procedure

1 Log in to the Web Server and select [Alarm Information] in the [Welcome] screen.

NOTE

- For information on setting up and connecting to the Web Server, see the following.
 "36.7 Displaying Addresses on the Web Server and Changing Address Values" (page 36-35)

2 When the following screen appears, in the [Block Number] field select the alarm block number to display, and in the [Record Format] field select the alarm display mode. The [Refresh] command lists the current alarm information as follows (example, [Block Number] = Block 1, [Record Format] = History).

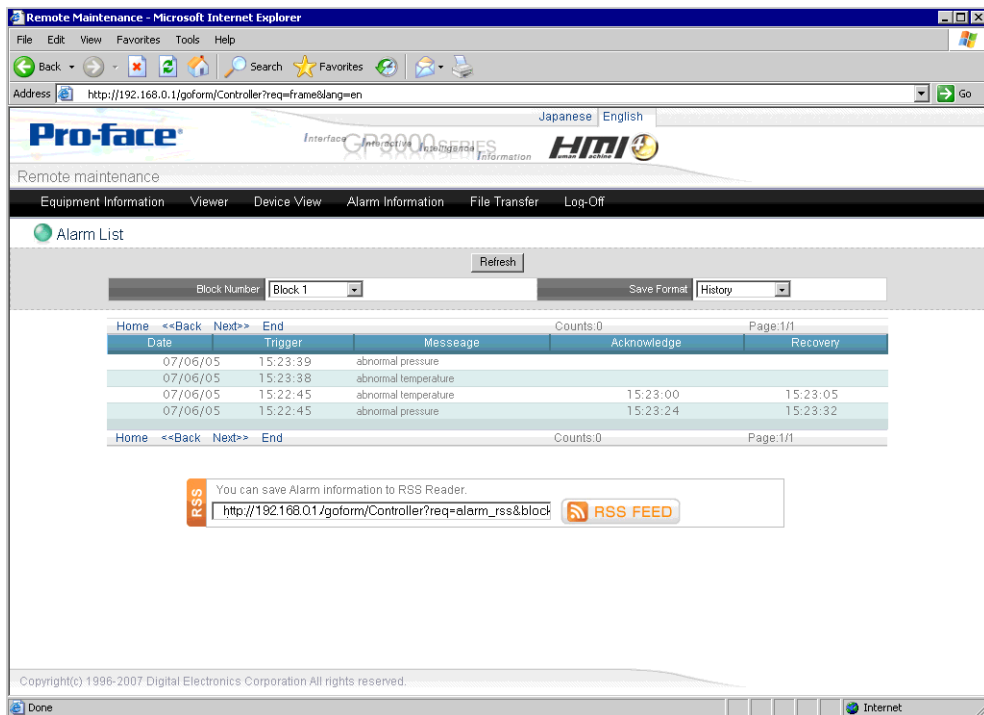

3 The RSS URL appears in the [RSS] field, and the alarm information is displayed. Set up this URL as the RSS reader address.

NOTE

- For information on setting up the displayed URL address in the RSS reader application, refer to the documentation that accompanies the RSS reader.
- Check the Pro-face support site "Otasuke Pro!" (<http://www.pro-face.com/otasuke/>) for RSS readers that have been confirmed to work with GP-Pro EX.

4 Alarm information displays on the RSS reader as shown in the following image. Select Update Information to check the alarm information list. Alarm information is updated whenever the alarm is triggered and recovered. Note, the following illustration is only a sample. The RSS reader determines how the information is displayed.

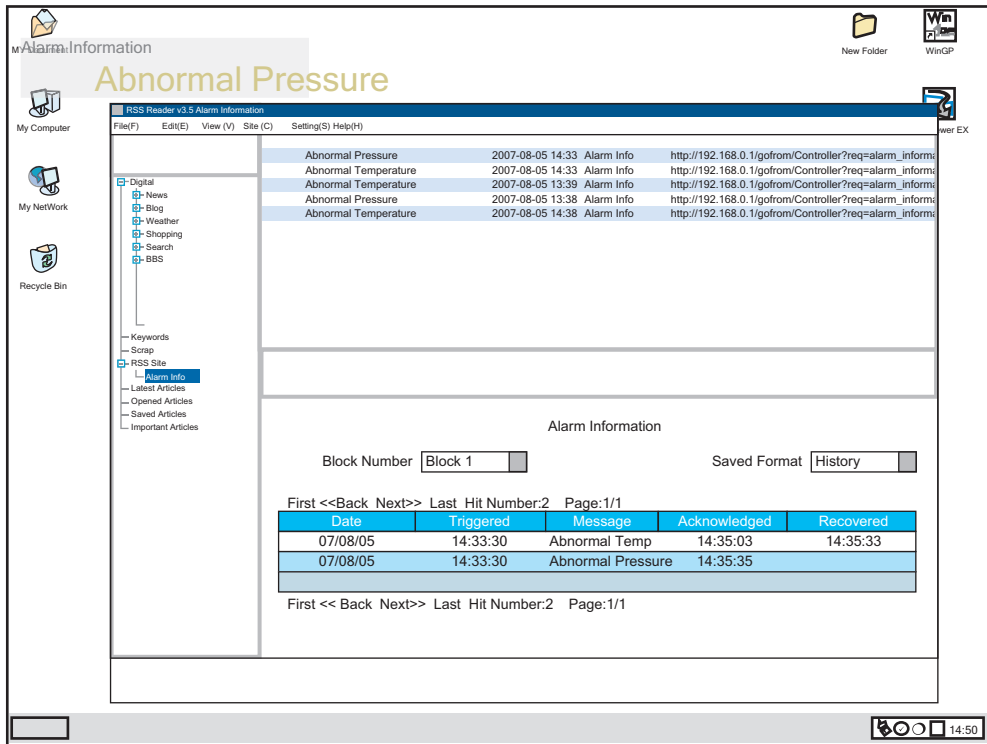

36.10 Using the Web Server to Transfer Files to the CF Card or USB Storage

36.10.1 Introduction

External storage devices such as CF cards or USB storage enable you to move files between the GP and computer without using the Transfer Tool. These storage devices further allow you to copy files from one GP to another.

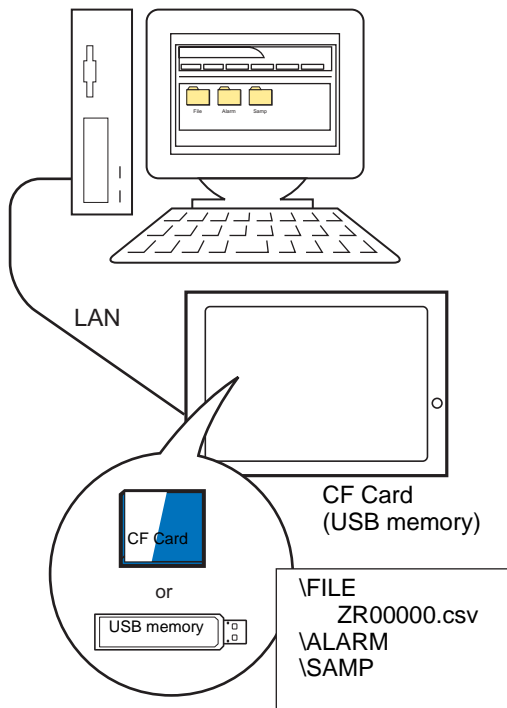

36.10.2 Setup Procedure

To use the Web Server to transfer files to the CF card or USB storage, define the file transfer destination folder in GP-Pro EX.

NOTE

- To use the Web Server's FTP server feature, change the Internet options. For information on the setup procedure, see the following.
☞ "36.7.3 Operating Procedure ■ Starting and Setting up Internet Explorer" (page 36-42)

◆ FTP Server

- 1 In the System Settings workspace, select [Display Unit] and click the [Remote Viewer] tab. In the [FTP] group, select [Enable FTP], for the [Destination] option select where the files are stored, and in the [Folder] field define the destination folder (example, [Destination] = CF Card, [Folder] = WebSite).

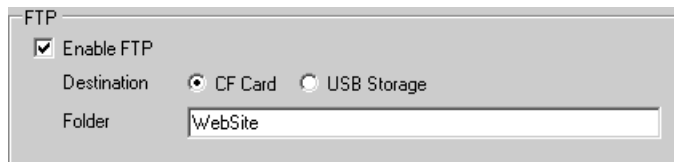
**NOTE**

- For the FTP destination folder, you can define the same folder as the Web Server destination folder.

- 2 Save the project and transfer to the GP.

- ☞ "32.2 Transferring Project Files via USB Cable Transfer" (page 32-5)
- ☞ "32.3 Transferring Project Files via Ethernet (LAN)" (page 32-12)

◆ Security

NOTE

- Please refer to the settings guide for details.
☞ "21.7.1 Common (Security Settings) Settings Guide" (page 21-19)

Set up security level 15 and password "5555" for maintenance staff. Set up security level 1 and password "1111" for status monitoring staff.

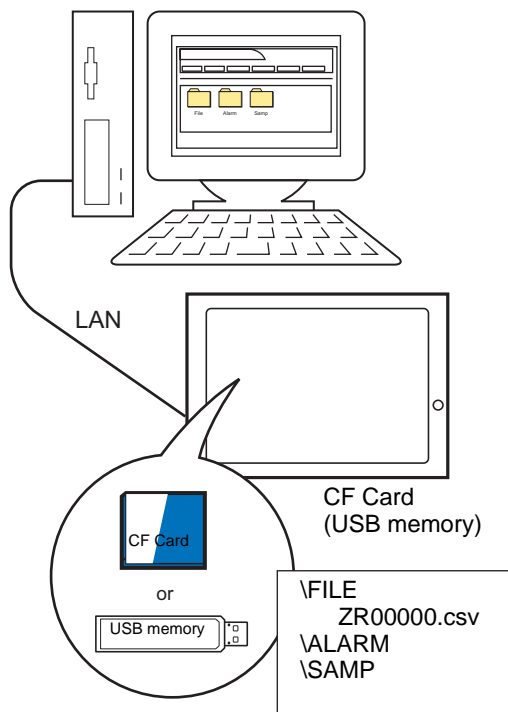

NOTE

- Security level 0 means no security is set.

1 From the [Common Settings (R)] menu, point to [Security (Q)] and select [Security Password] or click  on the toolbar.

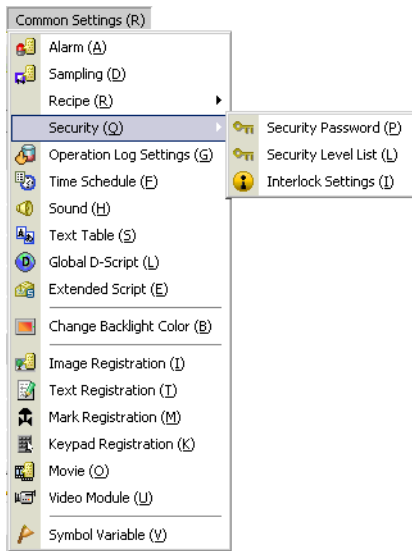

2 In the Passwords screen, select the [Enable Security Function] check box and type password "1111" for [Level 1], and password "5555" for [Level 15].

Enable Security Function

Add User ID Create Delete

Level	Password	
1	1111	
2		
3		
4		
5		
6		
7		
8		
9		
10		
11		
12		
13		
14		
15	5555	

NOTE

- Each password should be 8 single-byte characters or less.

3 Next, when you select the [Set up Functions at Each Security Level] check box, you can define which functions are permitted at each security level (example, [Review files in FTP folder] = Level 1, [Save or delete files in FTP folder] = Level "15").

Set up Functions at Each Security Level

Item	Level
read or write on-viewer Data	0
View Web Server Contents	0
Read Web Server Data	0
Read or Write Web Server Data	0
Review files in FTP folder	1
Save or delete files in FTP folder	15

36.10.3 Operating Procedure

1 Log in to the Web Server and select [File Transfer] in the [Welcome] screen.

NOTE

- For information on setting up and connecting to the Web Server, see the following.
☞ "36.7 Displaying Addresses on the Web Server and Changing Address Values" (page 36-35)

2 When security is set up, the [Log in] dialog box appears. Enter the [User Name] and password that correspond to the security level you want to work in (example, Maintenance = "5555").

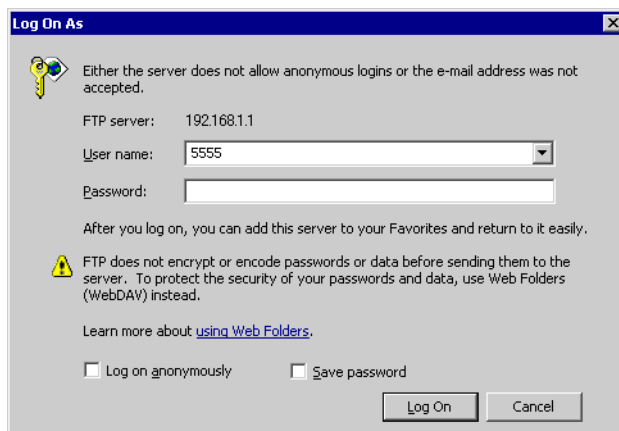

NOTE

- When the [User ID] is set up in the security settings, in the [User Name (U)] field input the user ID and in the [Password (P)] field input the password.
- If security is set up and you exit the Web Server, the next time you reconnect, even if you type the URL to connect directly to the site, you need to input the password again.
- Instead of the [Login] dialog box, if an FTP folder error message appears, click [OK] to close the message box. To display the [Login] dialog box, from the [File] menu select [Login].

- 3 The contents of the destination folder appears. You can overwrite files, delete files, and other operations corresponding to your login security level.

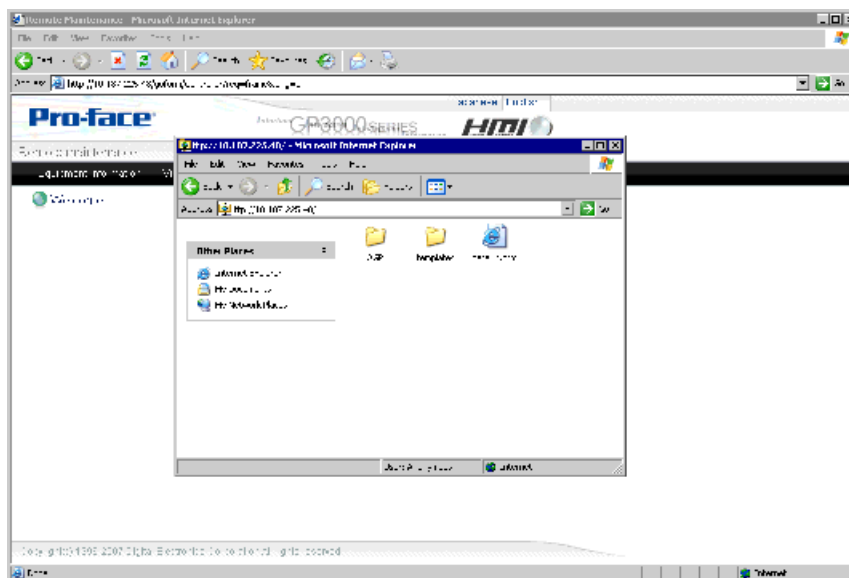
**NOTE**

- Using FTP, you can interact with the CF Card or USB storage. You can get the file list, get files, delete files, change file attributes, and write files.

36.11 Restricting Access to the Web Server

36.11.1 Introduction

Sets up security to restrict which people can display and operate data displayed on the Web Server. Set up security level 15 and password "5555" for maintenance staff. Set up security level 1 and password "1111" for status monitoring staff.

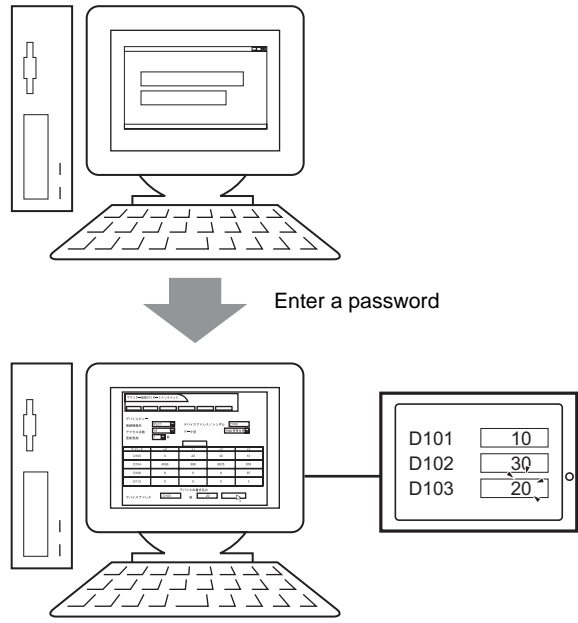

36.11.2 Setup Procedure

NOTE

- Please refer to the settings guide for details.
☞ "21.7.1 Common (Security Settings) Settings Guide" (page 21-19)

Set up security level 15 and password "5555" for maintenance staff. Set up security level 1 and password "1111" for status monitoring staff.

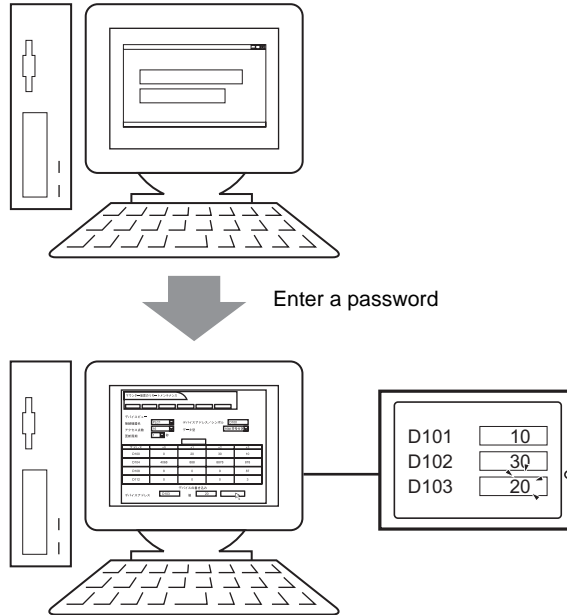

NOTE

- Security level 0 means no security is set.

■ **Level Mode**

Registers passwords for security levels 1 to 15 and defines the security level for each display screen.

- 1 From the [Common Settings (R)] menu, point to [Security (Q)] and select [Security Password] or click  on the toolbar.

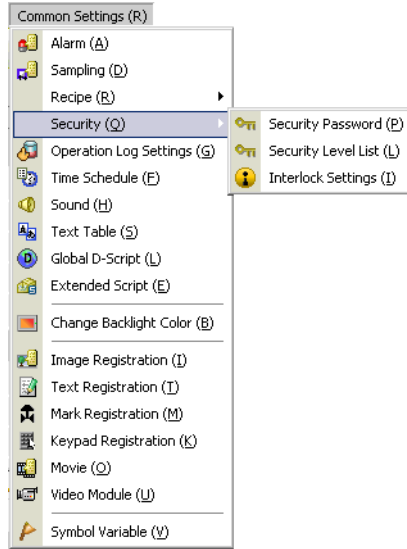

- 2 In the Passwords screen, select the [Enable Security Function] check box and type password "1111" for [Level 1], and password "5555" for [Level 15].

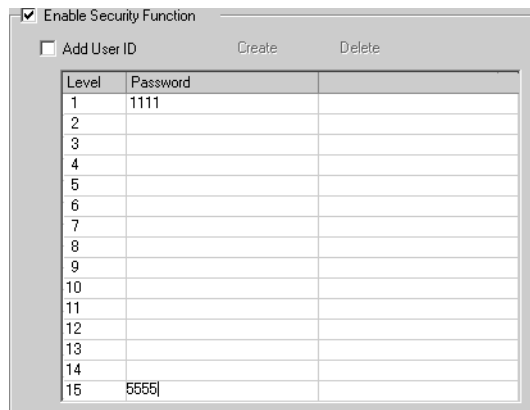

NOTE

- Each password should be 8 single-byte characters or less.

- 3 Next, select the [Set up Functions at Each Security Level] check box and define the security level for each [Item] (example, [Read Web Server Data] = Level "1", [Read or Write Web Server Data] = Level "15").

Set up Functions at Each Security Level

Item	Level
read or write or-viewer Data	0
View Web Server Contents	0
Read Web Server Data	1
Read or Write Web Server Data	15
Review files in FTP folder	0
Save or delete files in FTP folder	0

■ User ID Mode

Register user IDs and passwords for each security level, then the security level for each display screen.

- 1 From the [Common Settings (R)] menu, point to [Security (Q)] and select [Security Password] or click  on the toolbar.

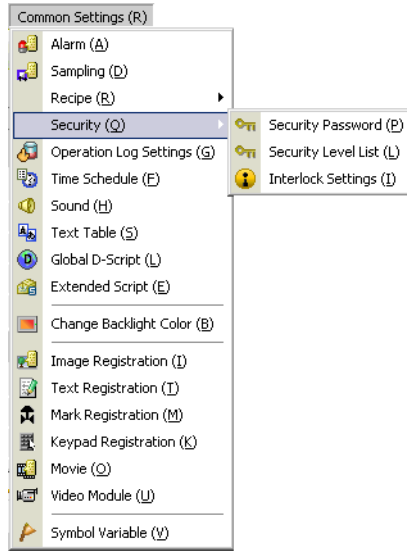

- 2 In the Set Password screen, select the [Enable Security Function] and [Add User ID] check boxes. Click [Create] to add one set of settings: Security Level, User ID, and Password.

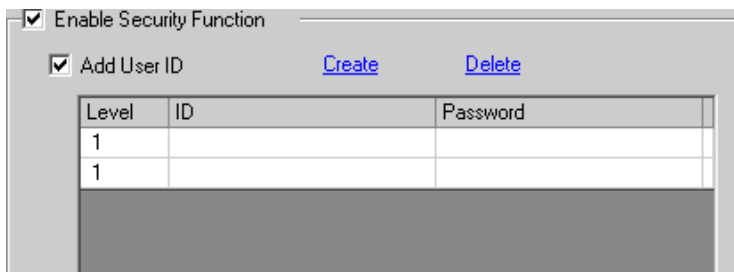

- 3 Set the security level, user ID, and password for status monitoring and maintenance staff (example, Status Monitoring: [Level] = "1", [Password] = "1111", [ID] = "Monitor"; Maintenance: [Level] = "15", [Password] = "5555", [ID] = "Admin").

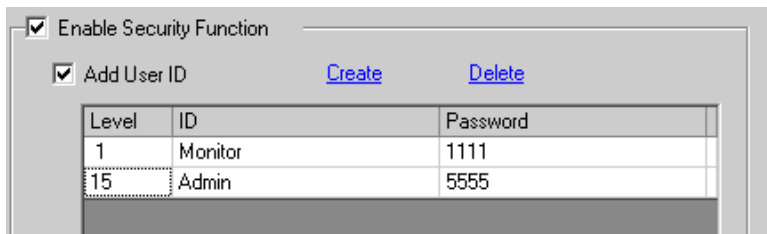

NOTE

- Each password should be 8 single-byte characters or less.

- 4 Next, when you select the [Set up Functions at Each Security Level] check box, you can define which functions are permitted at each security level (example, [Read Web Server Data] = Level 1, [Read or Write Web Server Data] = Level 15).

Set up Functions at Each Security Level

Item	Level
Read GP-Viewer Data	0
Read or Write GP-Viewer Data	0
View Web Server Contents	0
Read Web Server Data	1
Read or Write Web Server Data	15
Review files in FTP folder	0

36.11.3 Operating Procedure

- 1 Start Internet Explorer, and in the Address bar enter the IP address of the display unit.
(Example, 192.168.0.1)



- 2 Select a menu, such as [Device Menu], to display the [Input Network Password] dialog box.
Enter the password, which can be up to 8 single-byte characters long, and click [OK].
(Example, "5555" (Security level that enables viewing and operating GP data))

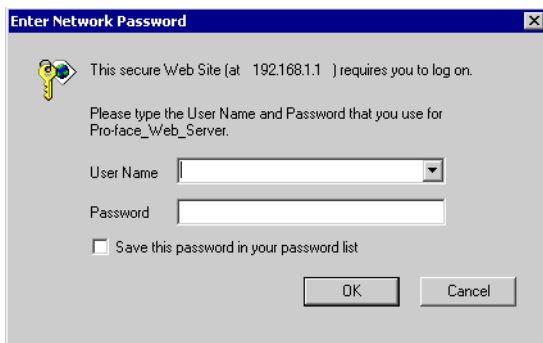

- 3 When you connect to the display unit's Web Server, the following [Welcome] screen appears.

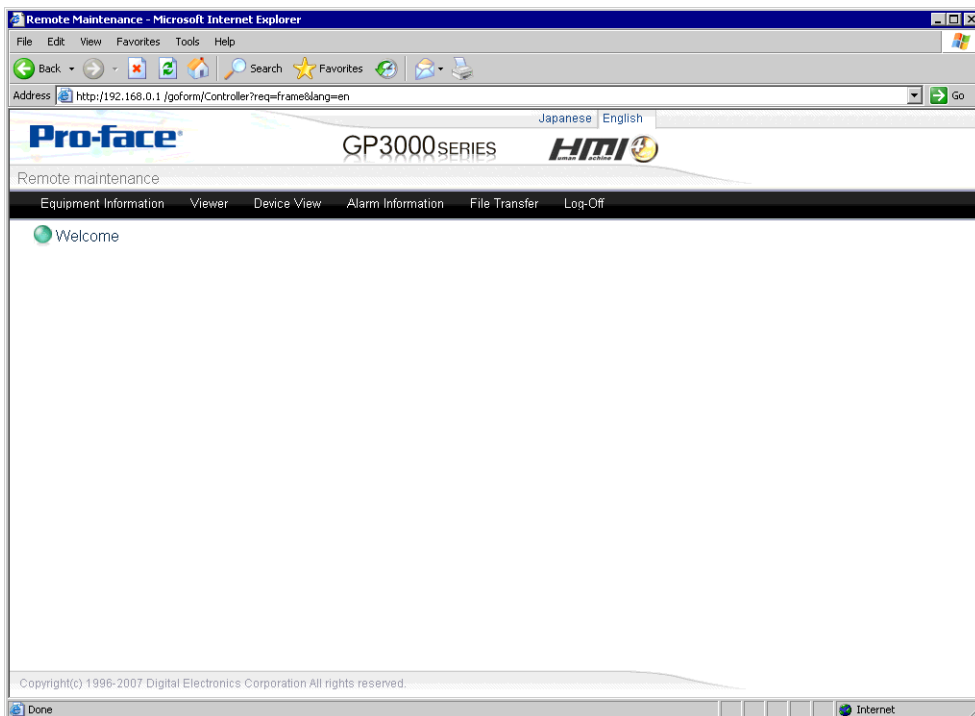

- 4 Select operations from the menu to interact with data on the display unit.

36.12 Settings Guide

36.12.1 Standard Template HTML Setting Guide

This section provides information about the standard HTML template Web pages installed with GP-Pro EX. The standard template Web page consists of three frames: the header, footer, and main frame. The standard HTML template is installed in the following location.
C:\Program Files\Pro-face\GP-Pro EX 2.1\HTMLContent

NOTE

- To use the Web Server: a) In the System Settings workspace, click [Display Unit], then in the [Remote Viewer] tab, select the [Enable Web Server] check box, and b) Transfer the standard HTML template to the display unit.

■ Header Frame

The header frame is common to all page headings, except when logged off. Using the buttons in this frame, you can jump to each page.

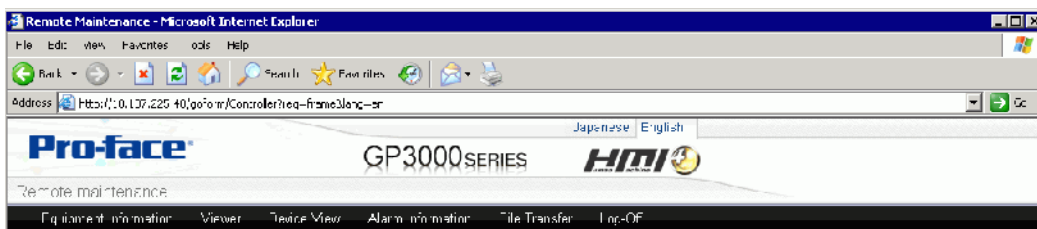

Setting	Description
Title	Displays the title of a Web page.
Equipment information	Displays GP-Pro EX project settings.
Viewer	When GP-Viewer EX is installed, starts the GP-Viewer EX application.
Device View	Monitors device addresses of devices or PLCs connected to the GP.
Alarm information	Displays alarm information accumulated in the GP.
File transfer	Using Internet Explorer, you can connect to the GP as a FTP client to access data in its CF card or USB storage.
Log off	Disconnects the GP and closes the window.
Japanese/English	Switches between the Japanese and English versions of the standard HTML template.

■ Footer Frame

The footer frame displays on the bottom of all pages.

Copyright(c) 1996-2007 Digital Electronics Corporation All rights reserved.

■ Main Frame

Changes to the page corresponding to the button selected in the [Header Frame].

◆ Log in

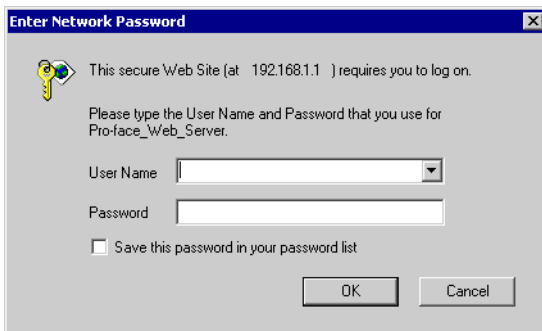

Setting	Description
User Name	Enter the user name with up to 8 single-byte characters, as set up in the GP-Pro EX security settings. If user names have not been set up, displays a blank.
Password	Enter the user name with up to 8 single-byte characters, as set up in the GP-Pro EX security settings.
Save password	Select the check box to save the password for the [User Name]. The next time you log in, after you enter the user name, all you have to do is click [OK] without entering a password.

◆ Welcome Page

Displays the login name for the computer.

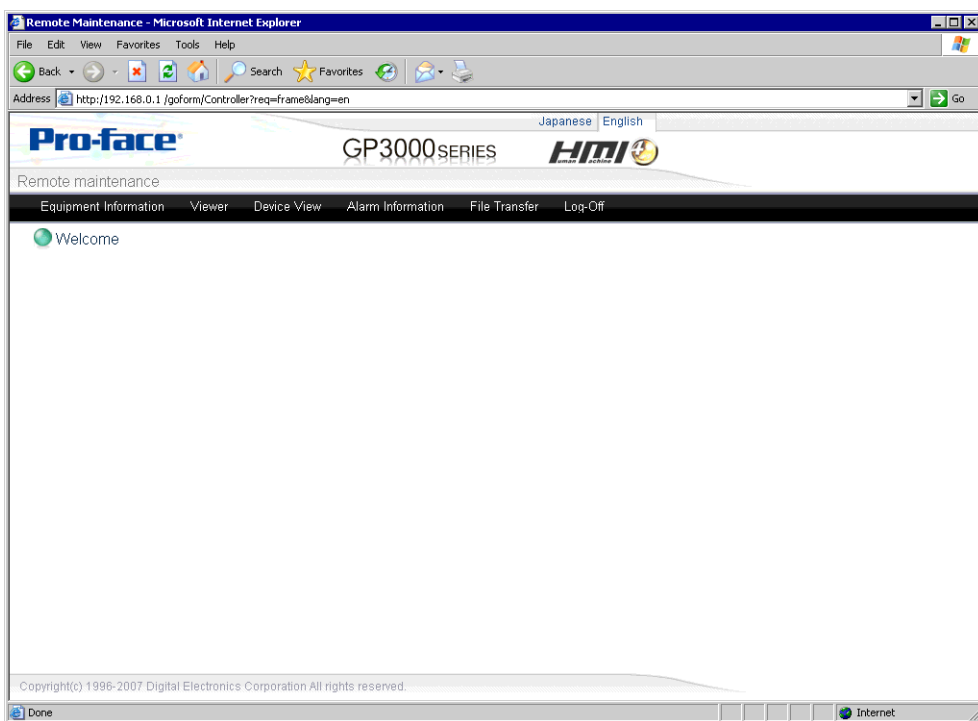

◆ **Device Information Page**

Displays the project and network project settings. You can view these settings, but you cannot change them.

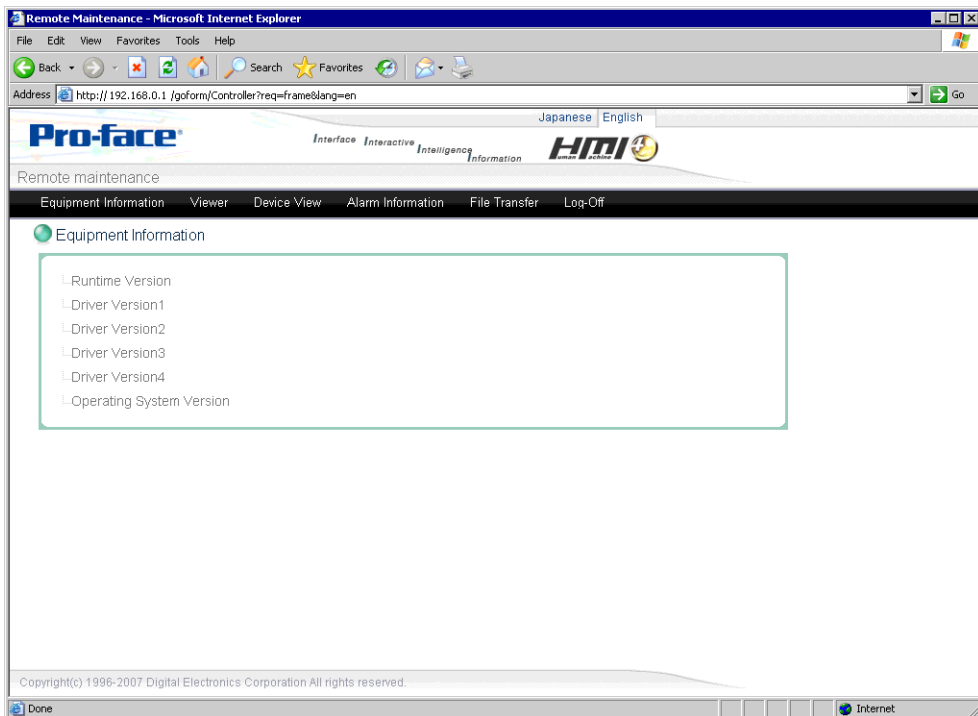

Setting	Description
Runtime Version	Displays the GP Runtime version.
Driver Version 1 to 4	Displays the protocol driver version. If you are connecting the maximum 4 drivers, the version of each driver is displayed.
Operating system version	Displays the GP operating system version.

◆ GP-Viewer EX Page

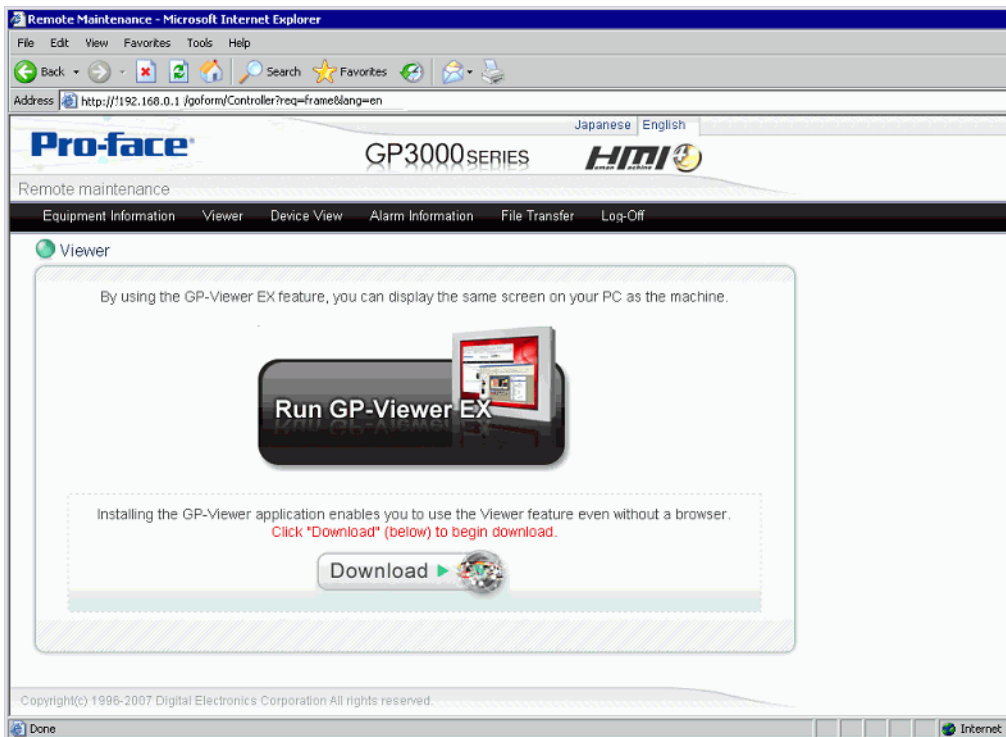

Setting	Description
Run GP-Viewer EX	On the computer where GP-Viewer EX is installed, this is a shortcut key to start up GP-Viewer EX.
Download	Downloads GP-Viewer EX.

◆ Device View Page

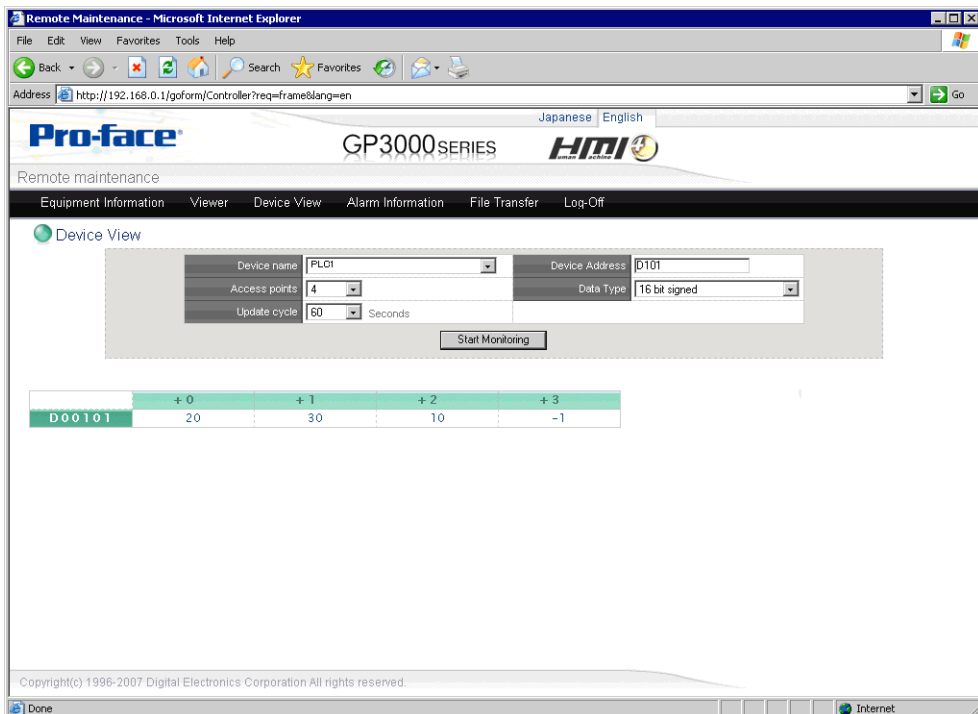

Setting	Description
Device/PLC Name	Selects devices/PLCs connected to GP.
Device Address	Sets up the start address of device addresses to monitor. You cannot specify Symbols.
Access points	Select the number of address points to display and access in one screen: [1], [2], [4], [8], [16], [32], [50], [100], or [200].
Data Type	Define the bit length and data type of addresses: [Bit], [16 Bit Signed], [16 Bit Unsigned], [16 Bit HEX], [32 Bit Signed], [32 Bit Unsigned], [32 Bit HEX], [Single-precision Floating Point], [Double-precision Floating Point], or [Text].
Update cycle	Select the monitoring frequency: [1], [2], [3], [4], [5], [10], [20], [60], [120], [180], or [300] seconds.
Start Monitoring	Starts monitoring device addresses at the defined frequency. Monitoring ends if you change the page or exit the browser.
Device Display Frame	Displays device addresses starting from the [Device Address] field, up to the number of addresses defined in the [Access Point] field.

◆ Alarm Information Page

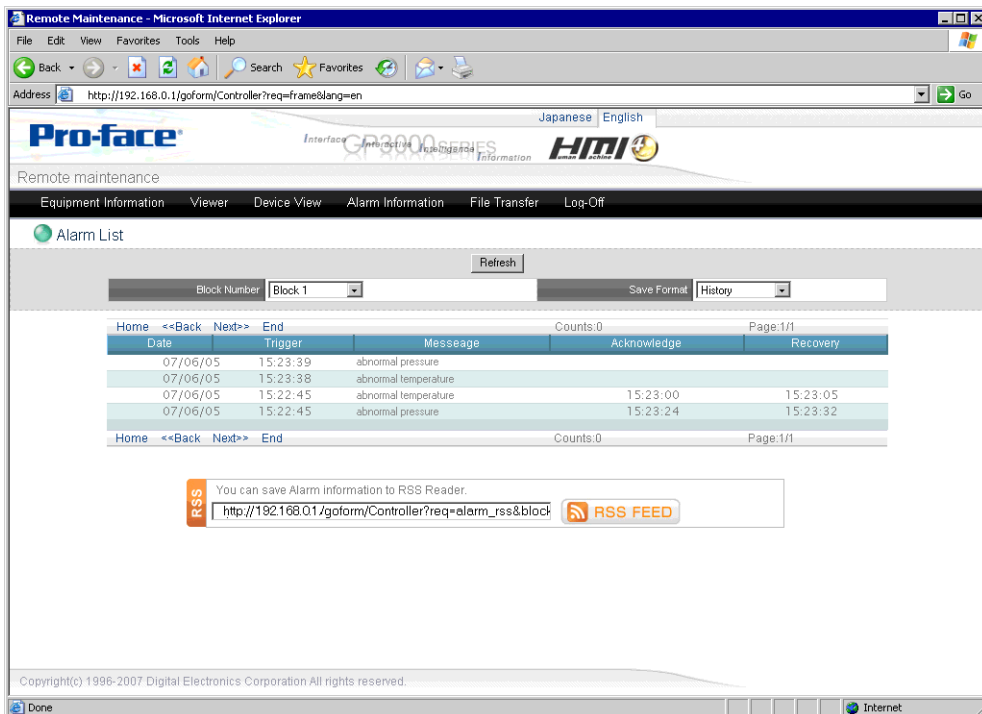

Setting	Description
Refresh	Updates alarm information and displays the latest information from the GP.
Block Number	Specifies the alarm block number (1 to 8) set up on the GP.
Save Format	Selects the alarm [Display Mode]: [History], [Log], or [Active].
Home	Displays the first line of the alarm.
Back	Moves back to the previous page.
Next	Moves to the next page.
End	Displays the last line of the alarm.
Alarm Display Frame	Displays alarm information.
Date	Displays the date and time when the alarm was triggered.
Trigger	Displays the time when an alarm is triggered.
Message	Displays the alarm message.
Acknowledge	Displays the time when an active alarm is acknowledged.
Recovery	Displays the time when an alarm is recovered.

Continued

Setting	Description
RSS	<p>Displays alarm information as RSS data. The RSS URL displays whenever changing the [Block Number] or [Save Format]. RSS data is displayed by inputting this URL into the address part of the RSS reader.</p> <p>NOTE</p> <ul style="list-style-type: none"> • Check the Pro-face support site "Otasuke Pro!" (http://www.pro-face.com/otasuke/) for RSS readers that have been confirmed to work with GP-Pro EX.
RSS FEED	You can register the URL of an RSS feed to the RSS reader. Operation of RSS feeds depend on your RSS Reader.

◆ **File Transfer Page**

Uses Internet Explorer as a FTP client and starts the Web page [File Transfer] operation. Using this operation, you can access the Destination folder, as defined in the System Settings workspace, [Display Unit] page, [Remote Viewer] tab. You can also access GP files on the FTP server.

NOTE

- Using FTP, you can interact with the CF Card or USB storage. You can get the file list, get files, delete files, change file attributes, and write files.

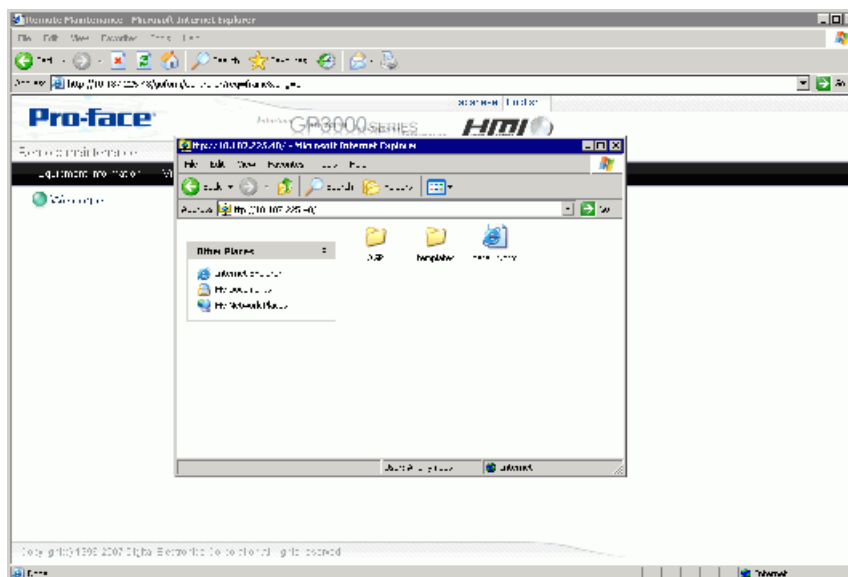

36.12.2 System Settings [Display Unit] - [Remote Viewer] Settings Guide

Display Unit
 Series GP3000 Series
 Model AGP-3500T
 Orientation Landscape

Display Unit

Display | Operation | Mode | Logic | System Area | Extended Settings | Remote Viewer

Remote Viewer

Enable Remote Viewer

Enable Screen Changes from Client

Web Server

Enable Web Server

Destination CF Card USB Storage

Folder

Default page when there is no file

HTTP Port Number

FTP

Enable FTP

Destination CF Card USB Storage

Folder

Reset

■ Viewer

Remote Viewer

Enable Remote Viewer

Enable Screen Changes from Client

Setting	Description
Enable	Sets up the GP-Viewer EX feature.
Enable Screen Changes from Client	Defines whether or not you can change the display screen from the GP-Viewer EX client. <div style="border: 1px solid black; padding: 5px; margin-top: 10px;"> <p>NOTE</p> <ul style="list-style-type: none"> • If this item is not selected, even users with read/write privilege (as defined in the security settings) cannot change the screen from GP-Viewer EX. </div>

■ Web Server

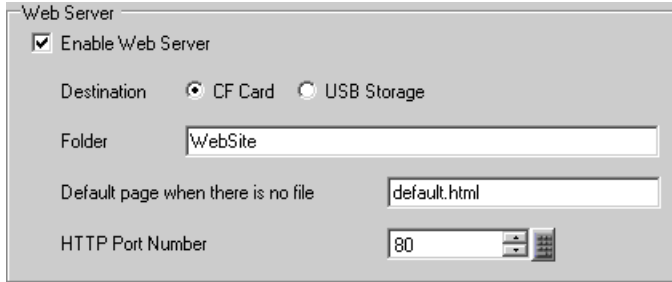

Setting	Description
Enable Web Server	Defines whether or not GP data is made available using a Web page.
Destination	Select either [CF Card] or [USB Storage] as the destination of the standard HTML template.
Folder	<p>Defines the folder path, up to 90 single-byte-characters long, to use as the Web Server on the CF card or USB storage.</p> <p>If you define the folder as "WebSite", and enter the address "http://ip_address/default.html" in Internet Explorer, it loads the Web page "WebSite\default.html" from the CF card or USB storage.</p> <p>Example: When referencing the "Website" folder on the CF card</p> <div style="text-align: center;"> </div> <p>NOTE</p> <ul style="list-style-type: none"> • As you can specify only a single folder as the Web Server's root folder, set up the destination to either USB storage or the CF card. • Slashes ("/" or "\") at the end of paths are automatically deleted when saving. Except in the case when the slash ("/" or "\") is the only character in the path.
Default page when there is no file name	<p>Defines the default file to display when no file name is defined in the http path. The maximum file name length is 90 single-byte characters.</p> <p>For example, when this property is set to "default.html", when you type "http://ip_address" into Internet Explorer's address bar, you are actually accessing "http://ip_address/default.html".</p> <p>NOTE</p> <ul style="list-style-type: none"> • When defining the [Folder] and [Default page when there is no file name] fields, when combined, do not exceed 90 single-byte characters.

Continued

Setting	Description
HTTP Port Number	<p>Set the Web-Server port number: 1 to 65535.</p> <p>NOTE</p> <ul style="list-style-type: none"> • For most applications, use port number 80. However, if 80 is not available because of the firewall or other issue, you may need to change the port number. • As the number of available ports is limited by the firewall, please confirm with your firewall settings.

■ FTP Settings



Setting	Description
Enable FTP	Select to use the FTP feature.
Destination	Select either [CF Card] or [USB Storage] as the location for the FTP server folder.
Folder	<p>Defines the CF card or USB storage folder path, up to 90 single-byte characters long, to share on the FTP server.</p> <p>If you define the folder as "FTPsite" and in Internet Explorer enter the address "ftp://ip_address/", the application displays the "WebSite" folder from the CF card or USB storage.</p> <p>Example:Referencing the CF Card's WebSite folder</p> <div style="text-align: center;"> </div> <p>NOTE</p> <ul style="list-style-type: none"> • As you can specify only a single folder as the Web Server's root folder, set up the destination to either USB storage or the CF card. • Slashes ("/" or "\") at the end of paths are automatically deleted when saving. Except in the case when the slash ("/" or "\") is the only character in the path.

■ Default Settings

Reset

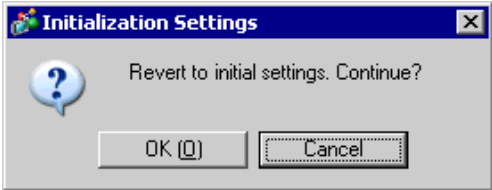
Setting	Description
Reset	<p>Resets all the settings in the [Remote Viewer], [Web Server], and [FTP] groups to their defaults.</p> <p>When you select the [Reset] button, the following confirmation message appears. Click [OK] to continue resetting properties to their defaults.</p> <div data-bbox="554 484 1044 672"></div>

36.13 Using Synchronous and Asynchronous Modes with GP-Viewer EX

36.13.1 Screen Mode

In screen mode, there are two methods of displaying GP-Viewer EX: Synchronous Mode and Asynchronous Mode. Synchronous mode shows the same screen data as the display unit. Asynchronous Mode shows screen data independent of screen changes on the display unit. The screen mode, the security level on the display unit, and the GP-Viewer EX login security level affect GP-Viewer EX operations. The following describes how the relationship between the screen mode and security level affects operations.

Screen mode	
Synchronous Mode	GP-Viewer EX displays the same screen as the display unit.
Asynchronous Mode	GP-Viewer EX can display a different screen than the display unit. Screen changes on the display unit do not affect the GP-Viewer EX screen.

36.13.2 On GP-Viewer EX Startup

The relationship between the screen mode and security level when starting up GP-Viewer EX is as follows.

Setting file	Screen mode when saving setting files	GP-Viewer EX operation
None	-	If you succeed in login at a security level of the screen displayed on the display and above, the screen of the display is displayed in [Synchronous Mode].
		As you do not have appropriate security access rights to view the current screen on the display unit, shows the display unit's initial screen in [Asynchronous Mode].
Enable	Synchronous Mode	If you succeed in login at a security level of the screen displayed on the display and above, the screen of the display is displayed in [Synchronous Mode].
		As you do not have appropriate security access rights to view the current screen on the display unit, shows the display unit's initial screen in [Asynchronous Mode].
	Asynchronous Mode	Shows the display unit's initial screen in [Asynchronous Mode].

36.13.3 When Changing Screens

(1) Synchronous Mode (When the display unit and GP-Viewer EX security levels are the same "1")

- Changing screens from the display unit

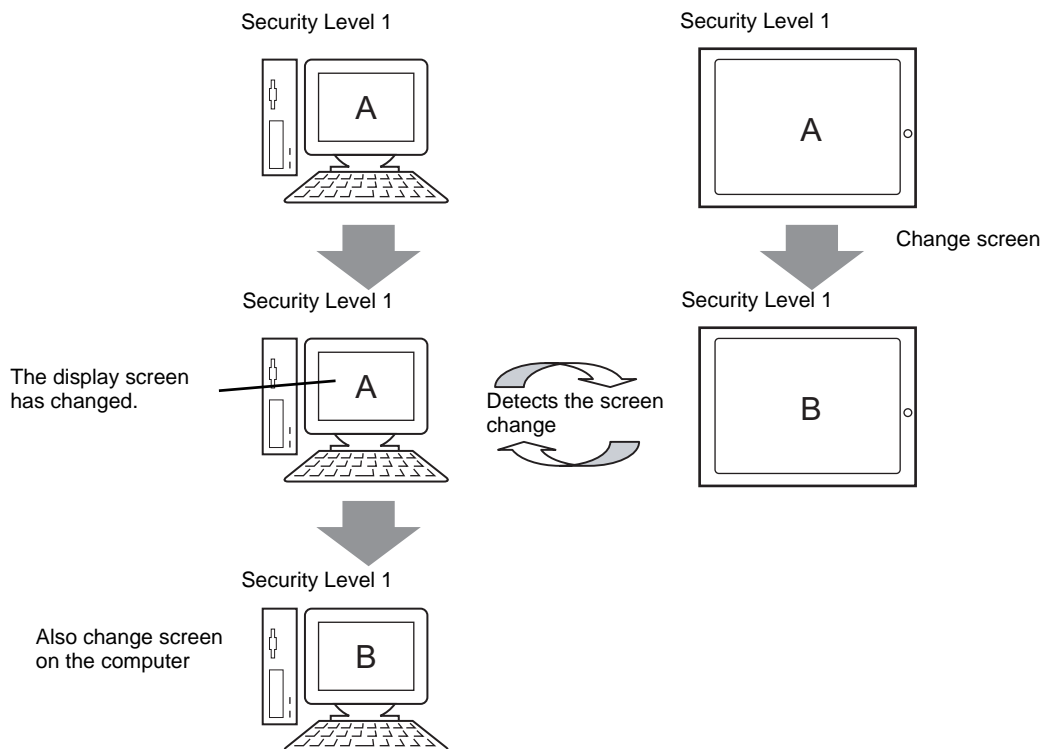

- Changing screens from GP-Viewer EX

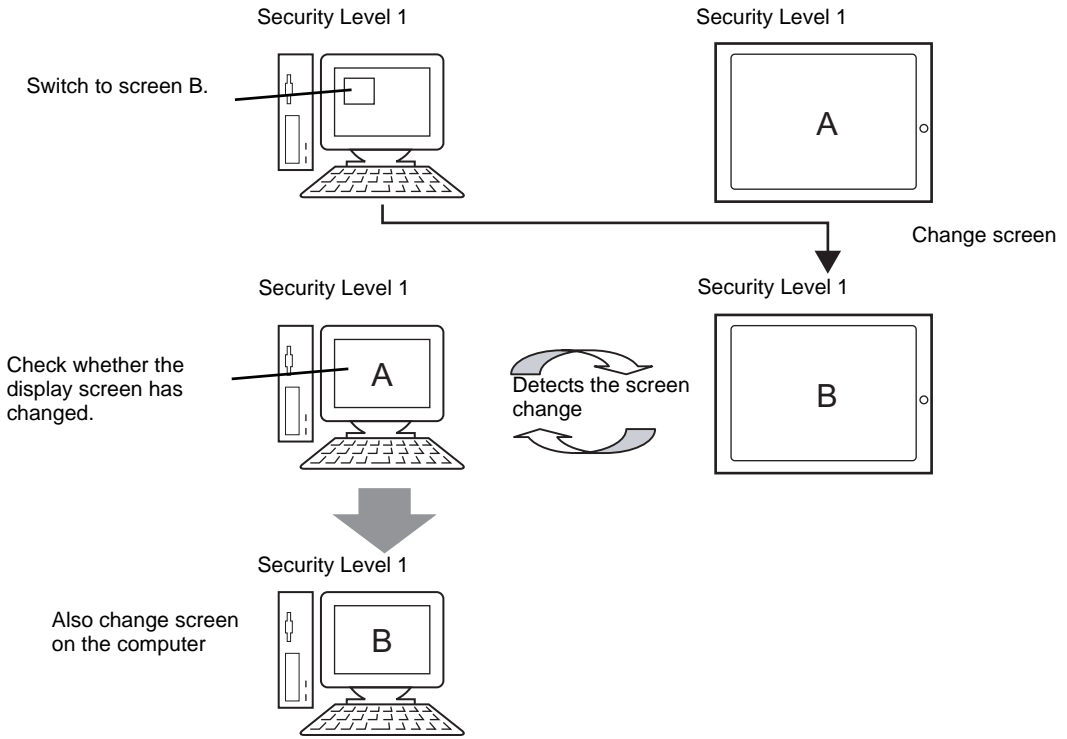

(2) Synchronous Mode (When the display unit security level is "10", and the GP-Viewer EX security level is "1")

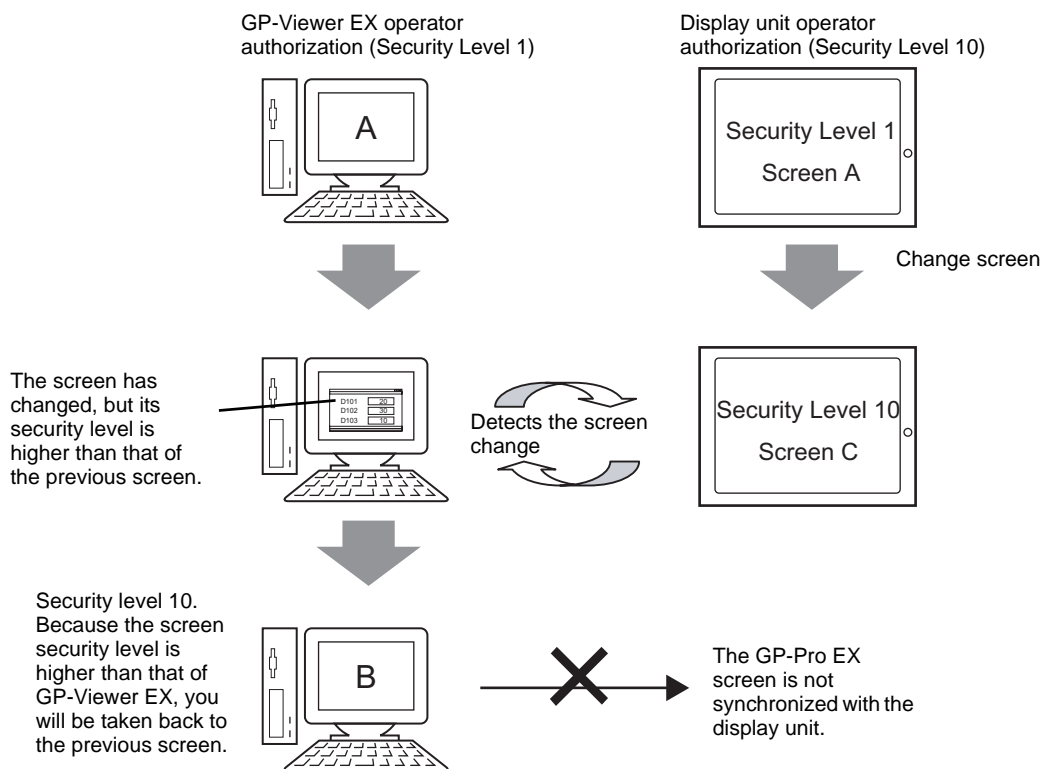

NOTE

- When GP-Viewer EX does not have access rights to security level 10, in the screen authentication dialog box click [Cancel] to return to the previous screen and enter [Asynchronous Mode].
- When GP-Viewer EX has access rights to security level 10, type the password to display the same screen as the display unit.
- If a popup window operation occurs at the same time as a screen change, even if authorization on the display unit is not at security level 10, the popup window operation may be forced through.

(3) Synchronous Mode (When the display unit security level is "1", and the GP-Viewer EX security level is "10")

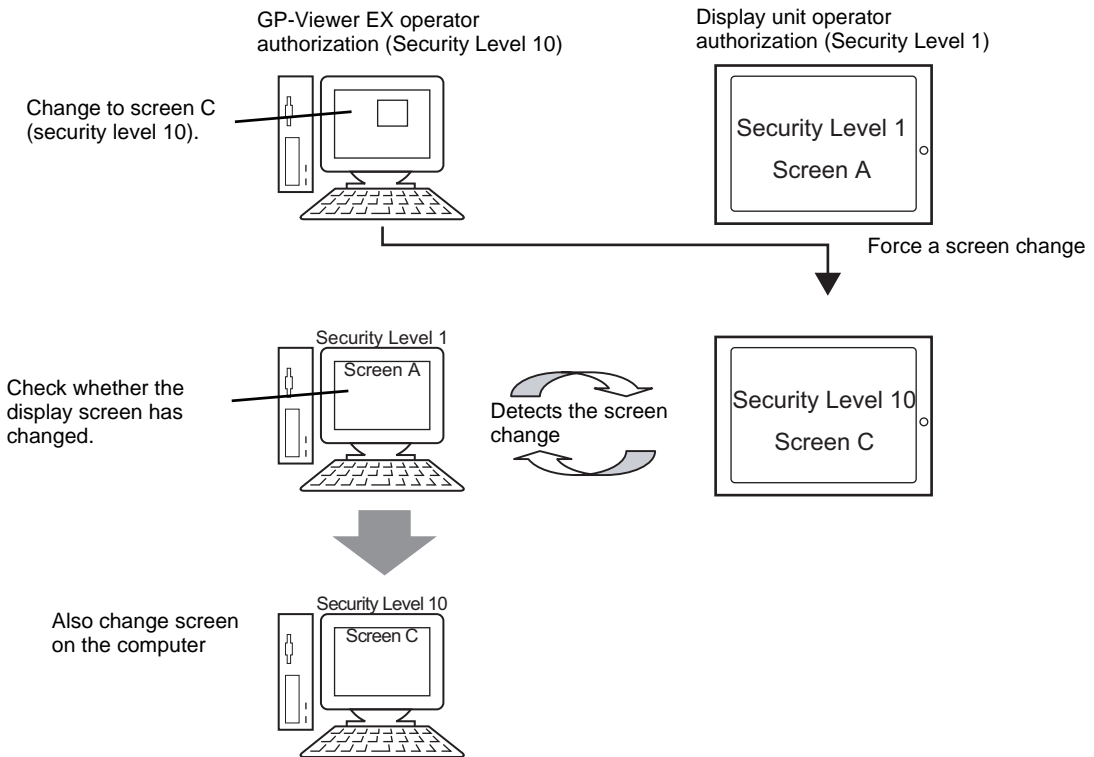

IMPORTANT

- When you use GP-Viewer EX to change the display unit to a higher security level screen, before terminating the GP-Viewer connection you should return the display unit to a screen with a security level that allows operations by the current panel operator. When you use GP-Viewer EX to temporarily change to a higher panel security level, the panel operator on the display unit logged in at a lower security level may not be able to run any operations. If you exit GP-Viewer EX with the display unit at a high security level, reconnect to the display unit using GP-Viewer EX then change to a lower security level screen.

(4) Asynchronous Mode (When the GP-Viewer EX security level is "1")

GP-Viewer EX does not synchronize its screen with the display unit. Even if a screen change occurs on the GP, GP-Viewer EX continues displaying the same screen.

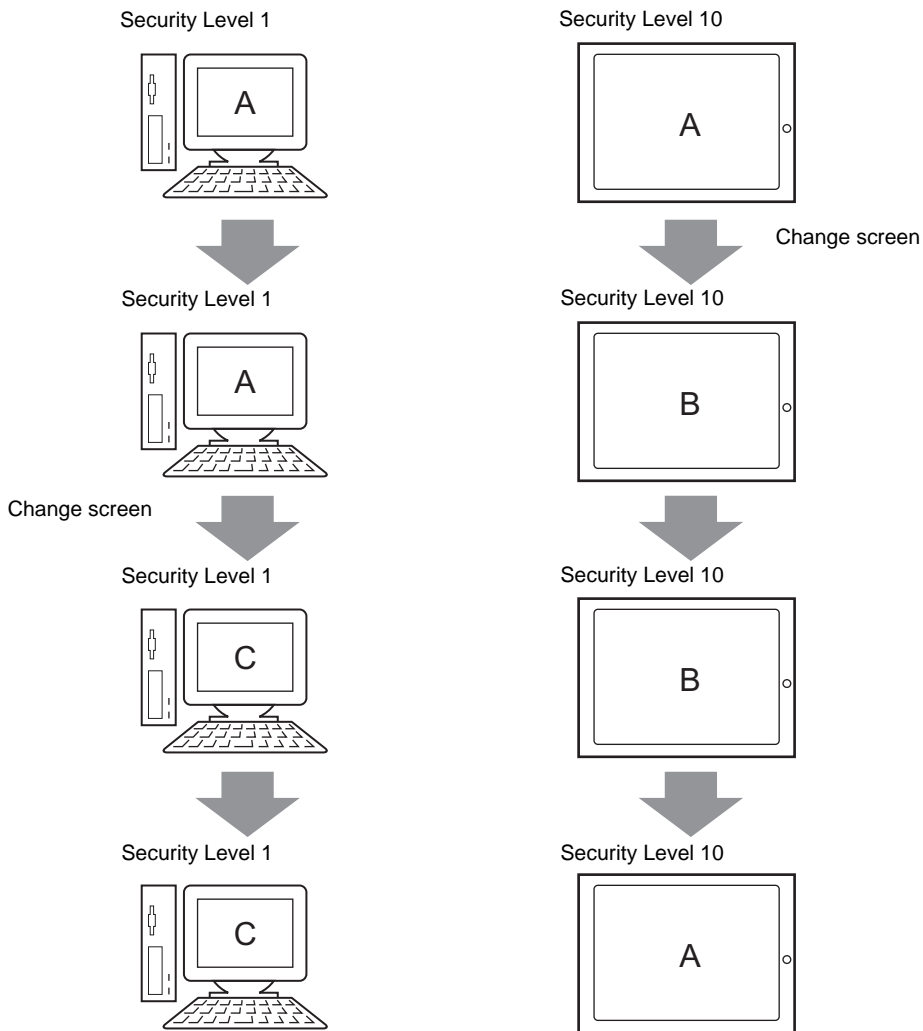

36.13.4 When Running Screen Operations

Screen mode	Change Screen (Enable/Disable)	Write from GP-Viewer EX	GP-Viewer EX operation
Synchronous Mode	O	O	Operations on GP-Viewer EX are reflected by the display unit. Note that only the displayed screen is the same, and that not all operations are synchronized. For example, for alarm display operations, the scroll position between the display unit and GP-Viewer EX may be different.
	X	O	You can view the current screen on the display unit and change device address values, but you cannot initiate screen change operations. However, if a change in a device address value triggers the screen change operation, then the display unit will change screens, and the GP-Viewer EX screen will follow suit.
	O	X	Remote display of the display unit screen. On screen change, an authentication screen displays. If authentication is successful, you can change screens from GP-Viewer EX. Successful authentication allows change screen operations with the connection, as well as write operations from GP-Viewer EX.
	X	X	Remote display of the display unit screen. Operations are not allowed. Changing screens on the display unit also changes screens in GP-Viewer EX.

Continued

Screen mode	Change Screen (Enable/Disable)	Write from GP-Viewer EX	GP-Viewer EX operation
Asynchronous Mode	O or X (Does not depend on the screen change settings)	O	You can use GP-Viewer EX to display a different screen from the display unit, to enable daily monitoring. If maintenance is required, login with the appropriate security level, and write values to device addresses.
	O or X (Does not depend on the screen change settings)	X	Always displays the defined screen. No operations are possible on the screen.

36.14 Restrictions

36.14.1 GP-Viewer EX Restrictions

- If the GP-Viewer EX installation path is longer than 80 single-byte characters, an error message displays indicating GP-Viewer EX cannot start because its install path is too long. Please reinstall GP-Viewer EX to an installation path less than 80 single-byte characters.
- You cannot install different versions of GP-Viewer EX on one computer.
- If you input the wrong key code, the key code will not be set. Input the correct key code.
- If you do not input key codes, the GP-Viewer EX trial version starts up.
- When connecting to the display unit without setting up key codes in GP-Viewer EX, the GP-Viewer EX trial version starts up.
- Regardless of the number of display units on the network, the maximum number of GP-Viewer EX windows you can display on one computer is 4. Conversely, the maximum number of GP-Viewer EX applications that can access the same display unit at the same time is 3.
- When starting GP-Viewer EX or clicking the update button, the display unit and GP-Viewer EX display the same alarm information. After that however, because the display unit and GP-Viewer EX monitor the alarm information independently, depending on the communication speed, the alarm summary displays may differ between the two.
- Because the display unit's external storage and GP-Viewer EX's virtual external storage are not directly synchronized, GP-Viewer EX cannot save alarm information.
- For errors that are automatically restored, such as communication errors with a connected device/PLC, the display unit may erase the error but the error remains in GP-Viewer EX. To remove the error, either change screens or click the Close button [x] in the system menu.
- When multiple errors are triggered at the same time, depending on the timing of when errors are received, all the errors may not display.

36.14.2 Web Server Restrictions

- The Web Server cannot be used without first being set up. In the System Settings workspace, [Display Unit] page, [Remote Viewer] tab, select the [Enable Web Server] check box. Please check this setting before transferring the project.
- Set up no more than 90 single-byte characters for the destination path of the standard HTML template and FTP server. To use the Web Server's standard HTML template, be sure to transfer the standard HTML template to the display unit. The Standard HTML template is installed in the following location.

C:\Program Files\Pro-face\GP-Pro EX 2.1\HTMLContents

For transfer methods, refer to the following.

☞ "32.10 Setting Up Transfer Tool" (page 32-56)

- You cannot transfer the standard HTML template when the GP has not been initialized. In any project, select the [Enable Web Server] check box and transfer it to the GP. Next, use the Transfer Tool's [Send Web site] command to transfer the standard HTML template.
- The system program on the display unit (Runtime) must be GP-Pro EX Ver2.10 or later, or you cannot transfer the standard HTML template to the display unit.
- The number of computers that can access the Web Server at the same time depends on the GP model. With the GP-3400, 3500, 3600, and 3700 Series, three computers can access at the same time. As for the GP-3200 and 3300 Series, as long as there are no memory issues, access is available only one computer at a time.
- You cannot customize the content in the [Device Information] main frame.
- The maximum number of alarms you can display on one [Alarm Information] page is 15.
- The maximum number of alarms you can display on RSS is 15.
- When Internet Explorer display settings are changed, such as the text size, the standard HTML may not display properly.
- When using the Web Server on GP-3200 and 3300 Series units, 1 MB from the User Screen Area is allocated to the Web Server. As a result, the Web Server adds 1 MB to the send data size.
- When using a RSS reader and the alarm records are either Active or History, recovery and acknowledge operations do not send update notifications to RSS reader. If you want to receive notification of recovery and acknowledge operations, use Log alarm records. However, note that the RSS reader has no way to distinguish between trigger, recovery, and acknowledge alarms.
- As the display unit does not identify the time zone, the Web Server's RSS information does not include time-zone information. As a result, different RSS readers might display different times.
- If a large number of browsers connect to the Web Server, too much load can be put on the Web Server, which could cause the Web Server to stop responding or break connections.
- When accessing the FTP server, the Internet Explorer folder display may not always update. If that happens, from the [View] menu, select [Refresh] or press the F5 function key.
- If you copy a folder with multiple subfolders on the FTP server, the login screen displays once for every file. Click [Cancel] to close the login screens.
- If you use the FTP server to overwrite read-only files, the [Login] dialog box displays. Click [Cancel] to close the dialog box.

- Connecting to the FTP server prevents screen and Web site transfers. Please logout before running screen or Web site transfer.
- When the following strings are used in alarm messages or in the device view, display is not possible because they match HTML tags. Please avoid using the following strings in alarm messages and in the device view.
<item>, <title>, <rdf>, <link>, <category>, <description>, <dc>, <channel>, <option>, </item>, </title>, </rdf>, </link>, </category>, </description>, </dc>, </channel>, </option> (Note: Brackets “<>” are included as part of the tag. Commas are not.)