



SIMATIC S7 MPI Direct Driver

1	System Configuration.....	3
2	Selection of External Device	5
3	Example of Communication Setting.....	6
4	Setup Items.....	12
5	Cable Diagram	17
6	Supported Device.....	20
7	Device Code and Address Code.....	22
8	Error Messages.....	23

Introduction

This manual describes how to connect the Display and the External Device (target PLC).

In this manual, the connection procedure will be described by following the below sections:

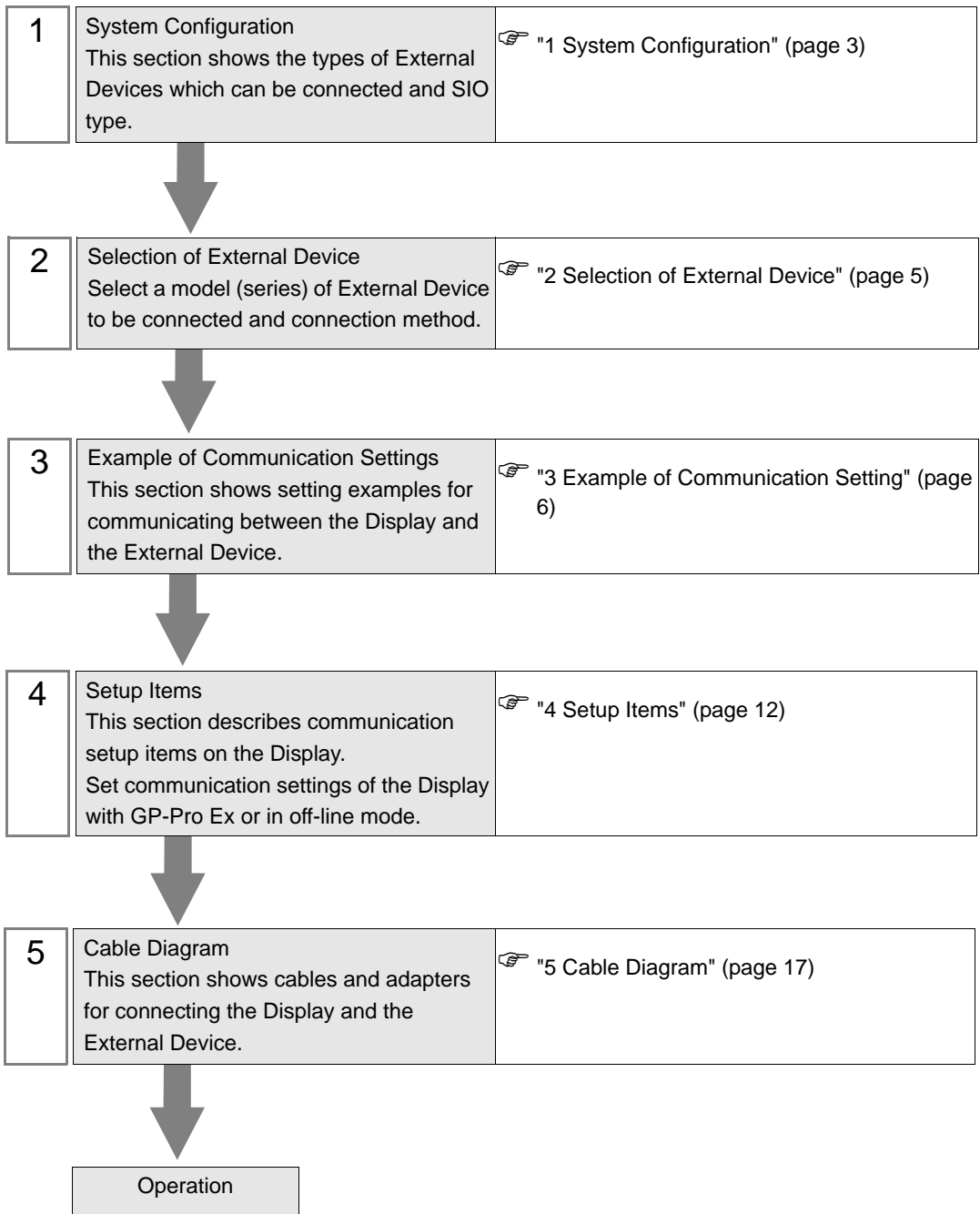

1 System Configuration

The system configuration in the case when the External Device of Siemens AG and the Display are connected is shown.

Series	CPU Module	Connection Port	SIO Type	Setting Example	Cable Diagram
SIMATIC S7-200 Series	CPU214 CPU215 CPU216 CPU221 CPU222 CPU224 CPU226	Port 0/1 on the CPU unit	RS422/485 (2wire)	Setting Example 1 (page 6)	Cable Diagram 1 (page 17)
SIMATIC S7-300 Series	CPU312IFM CPU313 CPU314 CPU314IFM CPU315 CPU315-2 DP CPU316 CPU316-2 DP CPU318-2	MPI port on the CPU unit	RS422/485 (2wire)	Setting Example 2 (page 9)	Cable Diagram 1 (page 17)
SIMATIC S7-400 Series	CPU412-1 CPU412-2 DP CPU413-1 CPU413-2 DP CPU414-1 CPU414-2 DP CPU414-3 DP CPU416-1 CPU416-2 DP CPU416-3 DP CPU417-4	MPI port on the CPU unit	RS422/485 (2wire)	Setting Example 2 (page 9)	Cable Diagram 1 (page 17)

IMPORTANT

- This manual is targeting at the SIMATIC S7 MPI Direct Driver (Ver.1.01.00 or higher).
- You can confirm the driver version in use within GP-Pro EX.
- Please confirm the driver version in use from the [Peripheral List] of the [System Setting window] in the work space.
- When a driver version is older than Ver.1.01.00, please download the latest driver from a support site "Otasuke Pro!".

Digital Electronics Corporation support site "Otasuke Pro!"
<http://www.pro-face.com/otasuke/>

■ Connection Configuration

MEMO

- You can mix the S7-300/400 Series and the S7-200 Series to use in one connection configuration.
- It is not recommended to mix the DP corresponding device and the MPI corresponding device for one connection constitution.
- When using more than one driver in a Display, you cannot use the DH-485 driver of Rockwell Automation, Inc and the MODBUS SLAVE of Schneider Electric Industries simultaneously. In addition, you cannot use SIMATIC S7 MPI Direct Driver in both COM1 and COM2.

- 1:1 Connection



- n:m Connection

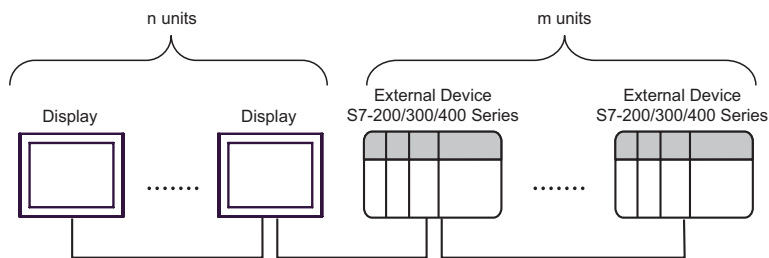

MEMO

- For n:m connection, the unit number of Display and External Device needs to be within the range which satisfies the conditions below.
 - You can connect max 16 units of the External Device to 1 unit of the Display.
 - Maximum unit number of the Display that can be connected to 1 unit of the External Device varies depending on the type of the External Device. Please refer to the manual of each External Device for checking.

2 Selection of External Device

Select the External Device to be connected to the Display.

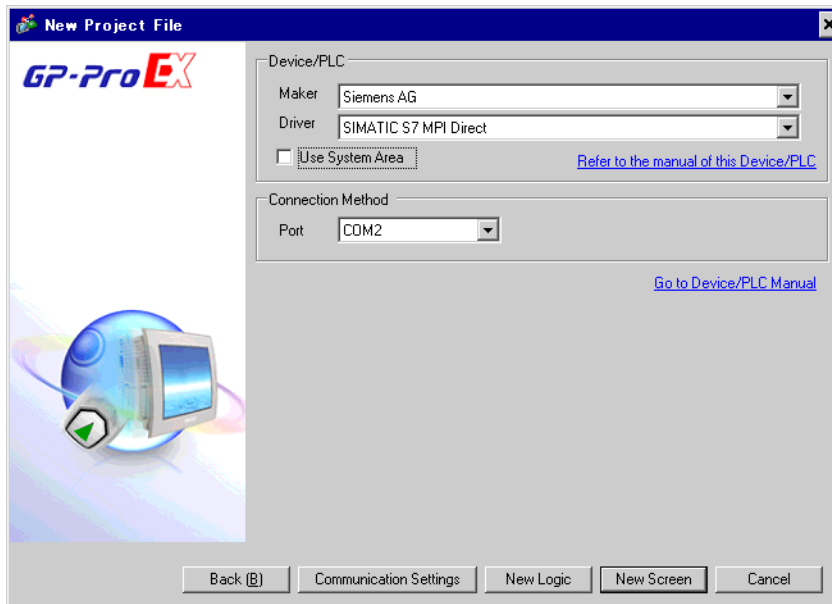

Setup Items	Setup Description
Maker	Select the maker of the External Device to be connected. Select "Siemens AG".
Driver	Select a model (series) of the External Device to be connected and connection method. Select "SIMATIC S7 MPI Direct". Check the External Device which can be connected in "SIMATIC S7 MPI Direct" in system configuration. ☞ "1 System Configuration" (page 3)
Use System Area	Check this option when you synchronize the system data area of the Display and the device (memory) of the External Device. When synchronized, you can use the ladder program of the External Device to switch the display or display the window on the Display Unit. Cf. GP-Pro EX Reference Manual "Appendix 1.4 LS Area (only for direct access method)" This can be also set with GP-Pro EX or in off-line mode of the Display. Cf. GP-Pro EX Reference Manual " 5.14.6 Setting Guide of [System Setting Window]■[Main Unit Settings] Settings Guide◆System Area Setting" Cf. Maintenance/Troubleshooting "2.14.1 Settings common to all Display models◆System Area Settings"
Port	Select the Display port to be connected to the External Device. MEMO • When connecting to S7-300/400 series, please use COM2.

3 Example of Communication Setting

Examples of communication settings of the Display and the External Device recommended by Pro-face, are shown as below.

3.1 Setting Example 1

■ Setting of GP-Pro EX

◆ Communication Settings

To display the setting screen, select [Device/PLC Settings] from [System setting window] in workspace.

The screenshot shows the 'Device/PLC 1' settings window. It is divided into several sections:

- Summary:** Includes fields for 'Maker' (Siemens AG), 'Driver' (SIMATIC S7 MPI Direct), and 'Port' (COM2). There is a 'Change Device/PLC' link.
- Text Data Mode:** Set to '1' with a 'Change' link.
- Communication Settings:**
 - SI0 Type:** Radio buttons for RS232C, RS422/485(2wire) (selected), and RS422/485(4wire).
 - Speed:** Dropdown menu set to 187500.
 - Data Length:** Radio buttons for 7 and 8 (selected).
 - Parity:** Radio buttons for NONE, EVEN (selected), and ODD.
 - Stop Bit:** Radio buttons for 1 (selected) and 2.
 - Flow Control:** Radio buttons for NONE (selected), ER(DTR/CTS), and XON/XOFF.
 - Timeout:** Spin box set to 3 (sec).
 - Retry:** Spin box set to 2.
 - Wait To Send:** Spin box set to 0 (ms).
- MPI Network:**
 - Local Node:** Spin box set to 1.
 - Highest Node Number:** Spin box set to 31.
 - Clock Synchronization on MPI (as Slave):** Checked checkbox.
- Device-Specific Settings:**
 - Allowable No. of Device/PLCs:** 16 Unit(s).
 - No. Device Name:** Table with 1 row: '1' | 'PLC1'.
 - Settings:** 'PLC Type=S7-200 Series (English Device Names), Target Node=2'.

A 'Default' button is located at the bottom right of the communication settings section.

◆ Device Setting

To display the setting screen, click  ([Setting]) of External Device you want to set from [Device-Specific Settings] of [Device/PLC Settings].

When [Allowable No. of Device/PLCs] is multiple, you can click  from [Device-Specific Settings] of [Device/PLC Settings] to add External Device which is available to set.

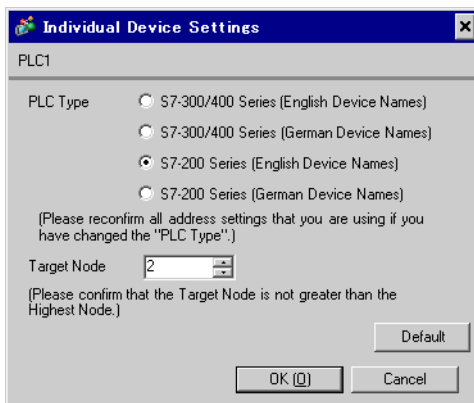

■ Settings of External Device

Use the ladder software "STEP 7 Micro/WIN 32" to perform the communication settings for the S7-200 Series.

- (1) Click [Communication] in the menu list. Check the connection among PLC (PORT0), the ladder cable (PC/PPI Cable) and the PC, and double-click [Double-Click to Refresh].
- (2) The [Search for Addresses] dialog box is displayed, and the software automatically scans the PLC. The dialog box is closed when the connection is checked.
- (3) Select [Type] from [PLC] on the menu bar.
- (4) The [PLC Type] dialog box is displayed. Select according to the connected PLC type, and click [OK].
- (5) Click [System Block] in the menu list, and set according to the port (Port0/Port1) to be actually connected to the Display as below.

Item	Setup Description
PLC Address	2
Highest Address	31
Baud Rate	19.2k
Retry Count	2
Gap Update Factor	10

- (6) When you finish setting, click [OK] and close the dialog box.
- (7) Click the [Down load] button in the command menu.
- (8) The [Download] dialog box is displayed. Click [OK].

◆ Restriction

- When using more than one driver in a Display, you cannot use the DH-485 driver of Rockwell Automation, Inc and the MODBUS SLAVE of Schneider Electric Industries simultaneously.
In addition, you cannot use SIMATIC S7 MPI Direct Driver in both COM1 and COM2.

3.2 Setting Example 2

■ Setting of GP-Pro EX

◆ Communication Settings

To display the setting screen, select [Device/PLC Settings] from [System setting window] in workspace.

The screenshot shows the 'Device/PLC 1' settings window. It is divided into several sections:

- Summary:** Includes fields for 'Maker' (Siemens AG), 'Driver' (SIMATIC S7 MPI Direct), and 'Port' (COM2). There is a 'Change Device/PLC' link.
- Text Data Mode:** Set to '1' with a 'Change' link.
- Communication Settings:**
 - SI0 Type:** Radio buttons for RS232C, RS422/485(2wire) (selected), and RS422/485(4wire).
 - Speed:** A dropdown menu set to 187500.
 - Data Length:** Radio buttons for 7 and 8.
 - Parity:** Radio buttons for NONE, EVEN (selected), and ODD.
 - Stop Bit:** Radio buttons for 1 (selected) and 2.
 - Flow Control:** Radio buttons for NONE (selected), ER(DTR/DS), and XON/XOFF.
 - Timeout:** A spin box set to 3 (sec).
 - Retry:** A spin box set to 2.
 - Wait To Send:** A spin box set to 0 (ms).
- MPI Network:**
 - Local Node:** A spin box set to 1.
 - Highest Node Number:** A spin box set to 31.
 - Clock Synchronization on MPI (as Slave):** A checked checkbox.
- Device-Specific Settings:**
 - Allowable No. of Device/PLCs:** 16 Unit(s).
 - No. Device Name:** A list showing '1 | PLC1'.
 - Settings:** A button to open the settings for the selected device.
 - Summary:** A bar at the bottom showing 'PLC Type=S7-300/400 Series (English Device Names),Target Node=2'.

◆ Device Setting

To display the setting screen, click  ([Setting]) of External Device you want to set from [Device-Specific Settings] of [Device/PLC Settings].

When [Allowable No. of Device/PLCs] is multiple, you can click  from [Device-Specific Settings] of [Device/PLC Settings] to add External Device which is available to set.

The screenshot shows the 'Individual Device Settings' dialog box for 'PLC1'. It contains the following settings:

- PLC Type:** Radio buttons for S7-300/400 Series (English Device Names) (selected), S7-300/400 Series (German Device Names), S7-200 Series (English Device Names), and S7-200 Series (German Device Names).
- Target Node:** A spin box set to 2.

There are two informational messages:

- “(Please reconfirm all address settings that you are using if you have changed the "PLC Type".)”
- “(Please confirm that the Target Node is not greater than the Highest Node.)”

Buttons at the bottom include 'Default', 'OK (O)', and 'Cancel'.

■ Settings of External Device

Use the ladder software "SIMATIC Manager" to perform the communication settings for the S7-300/400 Series. Set as below, following the steps.

Setup Items	Setup Description
Speed	187500 bps
Destination Node No.	2
Source Node No.	1 (Option: Set the smaller value than Max Value of Node No.)
Max Value of Node No.	31

- (1) Click the icon of [New Project].
- (2) Put the optional name and click [OK].
- (3) From the menu bar, select [Insert], [Station], [1 SIMATIC 400 Station] in this order.

MEMO • When using the S7-300 Series, select [2 SIMATIC 300 Station].

- (4) "SIMATIC 400(1)" is created in the project. Double-click [Hardware] in the CPU.
- (5) The "HW Config" screen is displayed. From the left tree, open [RACK- 400] from [SIMATIC 400], and select the base unit of the using model, then drag & drop to the upper right window.
- (6) Drag & drop the using power unit in the preset rack.
- (7) Similarly, drag & drop the using CPU unit.
- (8) Double-click the preset CPU unit "CPU xxx-xxx".
- (9) The dialog box for the MPI port setting is displayed. Open [Properties].
- (10) Check that "MPI(1)...187.5Kbps" is set as default. In addition, set [Address] which will be the destination node number (PLC Address) you set in GP-Pro EX (the default value "2" is used this time). Select "MPI(1)...187.5Kbps" and open [Properties].
- (11) Click the [Network Settings] tab.
- (12) You can change the transmission rate and the highest MPI address of the node No. in the dialog displayed (select [187.5Kbps] for the transmission rate). When you change the highest MPI address of the node No. (set to [31] this time), check the [Change] box to allow you to select the item. When you finish setting, click [OK].
- (13) Click [OK] in the dialog box displayed in step 12.
- (14) Click [OK] in the MPI port setting dialog box displayed in step 9.
- (15) Check the connection between the PLC and the ladder software. Open [Set PG/PC Interface] from [Options] in the menu bar.
- (16) The [Set PG/PC Interface] dialog box is displayed. Click [Properties].
- (17) Set [Transmission] to [187.5Kbps], and [Highest Node Address] to [31]. Click [OK].
- (18) Next click [Diagnostics].

(19)Click [Test] and [Read].

(20)If "OK" is displayed and other items than [0-0] of [Bus Nodes] are checked, the connection with the PLC is established. Click [OK] and close the dialog box.

(21)Open "Configure Network". Select the using CPU unit and click the [Download] button.

(22)When the "PLC Download Selected Stations" is displayed, click "Yes" and continue to download.

(23)When you finish downloading, the dialog box is closed.

(24)Close the [Configure Network] window. When the [Network Save and Compile] dialog box is displayed, click [Yes].

(25)When the [Save and Compile] dialog box is displayed, click [OK].

PLC setting is completed at above.

◆ Restriction

- When using more than one driver in a Display, you cannot use the DH-485 driver of Rockwell Automation, Inc and the MODBUS SLAVE of Schneider Electric Industries simultaneously.
In addition, you cannot use SIMATIC S7 MPI Direct Driver in both COM1 and COM2.

4 Setup Items

Set communication settings of the Display with GP-Pro EX or in off-line mode of the Display.

The setting of each parameter must be identical to that of External Device.

☞ "3 Example of Communication Setting" (page 6)

4.1 Setup Items in GP-Pro EX

■ Communication Settings

To display the setting screen, select [Device/PLC Settings] from [System setting window] in workspace.

Device/PLC 1

Summary [Change Device/PLC](#)

Maker Driver Port

Text Data Mode [Change](#)

Communication Settings

SIO Type RS232C RS422/485(2wire) RS422/485(4wire)

Speed

Data Length 7 8

Parity NONE EVEN ODD

Stop Bit 1 2

Flow Control NONE ER(DTR/DSR) XON/XOFF

Timeout (sec)

Retry

Wait To Send (ms)

MPI Network

Local Node Clock Synchronization on MPI (as Slave)

Highest Node Number

Device-Specific Settings

Allowable No. of Device/PLCs: 16 Unit(s)

No.	Device Name	Settings
1	PLC1	PLC Type=S7-300/400 Series (English Device Names),Target Node=2

Setup Items	Setup Description
SIO Type	Select the SIO type to communicate with the External Device.
Speed	Select speed between the External Device and the Display. IMPORTANT <ul style="list-style-type: none"> When connecting to the COM1 port of the Display, up to 19200bps is supported. When connecting to the COM2 port of the Display, 187500bps is supported.
Data Length	Select data length.
Parity	Select how to check parity.
Stop Bit	Select stop bit length.
Flow Control	Select the communication control method to prevent overflow of transmission and reception data.
Timeout	Use an integer from 1 to 127 to enter the time (s) for which the Display waits for the response from the External Device.
Retry	In case of no response from the External Device, use an integer from 0 to 255 to enter how many times the Display retransmits the command.

Setup Items	Setup Description
Wait To Send	Use an integer from 0 to 255 to enter standby time (ms) for the Display from receiving packets to transmitting next commands.
Local Node	Use an integer from 0 to 126 to enter the local node No. of the Display.
Highest Node Number	Select any of [15], [31], [63] and [126] for the highest value of the node No.
Clock Synchronization on MPI (as Slave)	Selecting (check mark) this checkbox enables the Time Master settings. When the Time Master is enabled with the Time Interval set via the External Device, the time data of Display Device will be overwritten by the Master External Device. Select the [H/W Configuration] → CPU menu's [Diagnostics Properties] → Diagnostics/Clock feature. For details, refer to your external device's Operation Manual

■ Device Setting

To display the setting screen, click  ([Setting]) of the External Device you want to set from [Device-Specific Settings] of [Device/PLC Settings].

When [Allowable No. of Device/PLCs] is multiple, you can click  from [Device-Specific Settings] of [Device/PLC Settings] to add the External Device which is available to set.

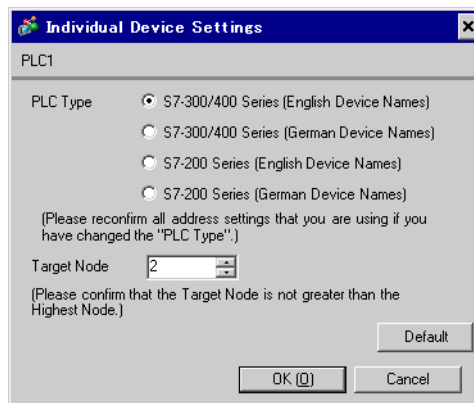

Setup Items	Setup Description
PLC Type	For the type of External Device to communicate, select any of [S-7-300/400 Series [English Device Names]], [S-7-300/400 Series [German Device Names]], [S-7-200 Series [English Device Names]] and [S-7-200 Series [German Device Names]]. Select [English Device Name] or [German Device Name] depending on whether the device name is described in English or German.
Target Node	Use an integer from 0 to 126 to enter the node No. of the External Device. Be sure to set the node No. within the range which does not exceed the value set in [Highest Node Number] of [Communication Settings].

4.2 Setup Items in Off-Line Mode

MEMO

- Please refer to Maintenance/Troubleshooting for more information on how to enter off-line mode or about operation.

Cf. Maintenance/Troubleshooting "2.2 Offline Mode"

■ Communication Settings

To display the setting screen, touch [Device/PLC Settings] from [Peripheral Settings] in off-line mode. Touch the External Device you want to set from the displayed list, and touch [Communication Settings].

(Page 1/2)

Comm.	Device			
SIMATIC S7 MPI Direct			[COM2]	Page 1/2
SIO Type		RS422/485(2wire)		
Speed		187500		
Data Length		8		
Parity		EVEN		
Stop Bit		1		
Flow Control		NONE		
Timeout(s)		3		
Retry		2		
Wait to Send(ms)		0		
(Maximum supported speed is 187500 for COM2 & 19200 for COM1 Please confirm that it is not greater than supported speed.)				
				➔
Exit		Back		2006/11/16 19:02:45

Setup Items	Setup Description
SIO Type	Select the SIO type to communicate with the External Device.
Speed	Select speed between the External Device and the Display.
Data Length	Select data length.
Parity	Select how to check parity.
Stop Bit	Select stop bit length.
Flow Control	Select the communication control method to prevent overflow of transmission and reception data.
Timeout	Use an integer from 1 to 127 to enter the time (s) for which the Display waits for the response from the External Device.
Retry	In case of no response from the External Device, use an integer from 0 to 255 to enter how many times the Display retransmits the command.
Wait To Send	Use an integer from 0 to 255 to enter standby time (ms) for the Display from receiving packets to transmitting next commands.

(Page 2/2)

Comm.	Device			
SIMATIC S7 MPI Direct		[COM2]	Page 2/2	
Local Node		1	▼	▲
Highest Node		31	▼	
Clock Synchronization		ON	▼	
(Please confirm that the Local Node is not greater than the Highest Node.)				
				←
Exit		Back		2006/11/16 19:02:53

Setup Items	Setup Description
Local Node	Use an integer from 0 to 126 to enter the local node No. of the Display.
Highest Node	Select any of [15], [31], [63] and [126] for the highest value of the node No.
Clock Synchronization	Selecting [ON] enables the Time Master settings. When the Time Master is enabled with the Time Interval set via the External Device, the time data of Display Device will be overwritten by the Master External Device. Select the [H/W Configuration] → CPU menu's [Diagnostics Properties] → Diagnostics/Clock feature. For details, refer to your external device's Operation Manual

■ Device Setting

To display the setting screen, touch [Device/PLC Settings] from [Peripheral Settings]. Touch the External Device you want to set from the displayed list, and touch [Device].

Comm.	Device			
SIMATIC S7 MPI Direct		[COM2]	Page 1/1	
Device/PLC Name <input type="text" value="PLC1"/>				
Series S7-300/400 English Device Names				
Target Node <input type="text" value="2"/>				
(Please confirm that the Target Node is not greater than the Highest Node.)				
Exit		Back		2006/11/16 19:02:56

Setup Items	Setup Description
Device/PLC Name	Select the External Device for device setting. Device name is a title of External Device set with GP-Pro EX.(Initial value [PLC1])
Series	Displays the PLC type selected in [Device Setting] of GP-Pro EX. You cannot change the PLC type in [Device Setting] in off-line mode. ☞ "4.1 Setup Items in GP-Pro EX ■Device Setting" (page 13)
Target Node	Use an integer from 0 to 126 to enter the node No. of the External Device. Be sure to set the node No. within the range which does not exceed the value set in [Highest Node] of [Communication Settings].

5 Cable Diagram

The cable diagram shown below may be different from the cable diagram recommended by Siemens AG. Please be assured there is no operational problem in applying the cable diagram shown in this manual.

- The FG pin of the External Device body must be D-class grounded. Please refer to the manual of the External Device for more details.
- SG and FG are connected inside the Display. When connecting SG to the External Device, design the system not to form short-circuit loop.
- Connect the isolation unit, when communication is not stabilized under the influence of a noise etc..

Cable Diagram 1

Display (Connection Port)	Cable		Notes
GP ^{*1} (COM1) AGP-3302B ^{*2} (COM2)	A	MPI cable by Pro-face ST03-A2B-MPI21-PFE (3.5m) ^{*3}	The cable length must be 50m or less in one segment.
GP ^{*4} (COM2)	B	Online adapter by Pro-face CA4-ADPONL-01 ^{*5} + MPI cable by Pro-face GP3000-MPI21-PFE (3.5m) ^{*4}	
	C	Siemens COM conversion adapter by Pro-face CA3-ADPSEI-01 + PROFIBUS cable ^{*6*7}	

*1 All GP models except AGP-3302B

*2 When use AGP-3302B, please install a ferrite core.

Recommended ferrite core: E04SR401938 (Seiwa Electric Mfg Co., Ltd.)

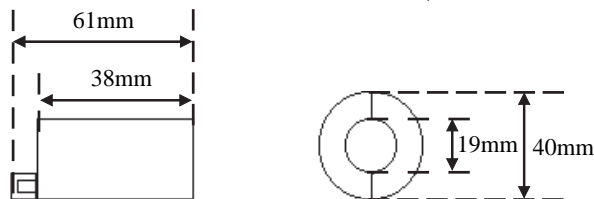

MEMO

If size is the same, you can use a ferrite core made by other companies.

- *3 There are Display side connector and the External Device side connector on the MPI cable. Check the Display side and the External Device side, and please connect correctly. When connecting Display side and External Device side adversely, it may be the reason for the destruction and the failure of the CPU unit.
- *4 All GP models except GP-3200 series and AGP-3302B
- *5 The online adapter is supplied with the MPI cable (GP3000-MPI21-PFE).
- *6 When using GP-3400/3500/3600 series, please use the PROFIBUS connector (straight type).
- *7 Please be aware that certain PROFIBUS cable have restriction on baudrate.

A) When using the MPI cable (ST03-A2B-MPI21-PFE (3.5m)) by Pro-face

- 1:1 Connection

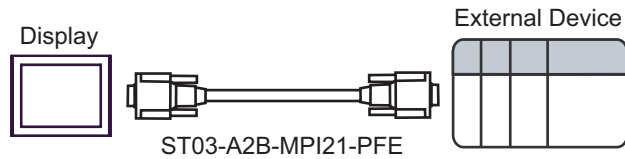

B) When using the online adapter (CA4-ADPONL-01) by Pro-face and MPI cable (GP3000-MPI21-PFE (3.5m)) by Pro-face

- 1:1 Connection

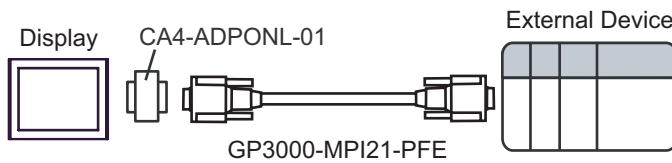

IMPORTANT

- Please do not connect online adapter and isolation unit to External Device side, as it may be the reason for destruction and the failure of the External Device.

C) When using the Siemens COM conversion adapter (CA3-ADPSEI-01) by Pro-face and PROFIBUS cable

- 1:1 Connection

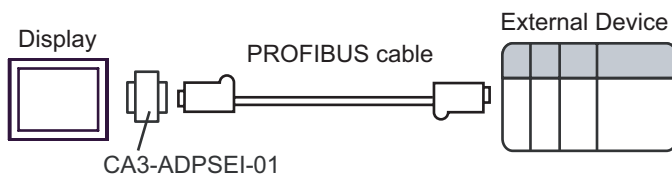

- 1:m Connection

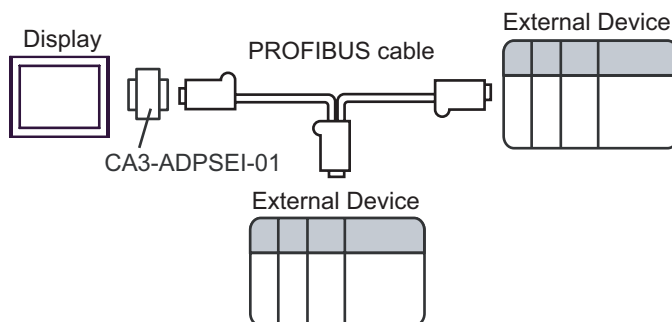

- n:1 Connection

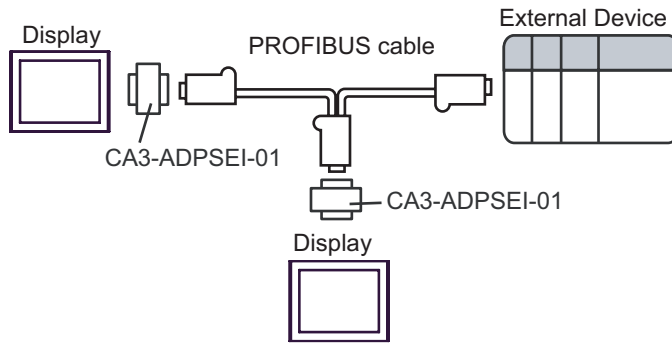
**IMPORTANT**

- Please turn ON the terminator switch on the connector of the PROFIBUS cable that becomes a terminal on the network.
- Please do not connect Siemens COM conversion adapter and isolation unit to External Device side, as it may be the reason for destruction and the failure of the External Device.

6 Supported Device

Range of supported device address is shown in the table below. Please note that the actually supported range of the devices varies depending on the External Device to be used. Please check the actual range in the manual of your External Device.

6.1 S7-200 Series

Device	Bit Address		Word Address		32 bits	Remarks	
	English	German	English	German			
Variables	-		VW00000-VW05118		H/L	± 2	
Input	I00000.0- I00015.7	E00000.0- E00015.7	IW00000- IW00014	EW00000- EW00014		± 2	*1
Output	Q00000.0- Q00015.7	A00000.0- A00015.7	QW00000- QW00014	AW00000- AW00014		± 2	*2
Internal Marker	M00000.0-M00031.7		MW00000-MW00030			± 2	
Timer	-		T00000-T00255				*3
Counter	-		C00000- C00255	Z00000- Z00255			*3

- *1 You cannot write to IW0 to IW2 depending on the CPU type. These addresses are reserved for onboard I/O. Please refer to the manual of your External Device for checking.
- *2 You can write in the QW and Q devices only when the External Device is in RUN mode. When the External Device moves to the STOP mode, the output will be reset.
- *3 Write disable

MEMO

- Please refer to the GP-Pro EX Reference Manual for system data area.
Cf. GP-Pro EX Reference Manual "Appendix 1.4 LS Area (only for direct access method)"
- Please refer to the precautions on manual notation for icons in the table.
☞ "Manual Symbols and Terminology"

6.2 S7-300/400 Series

Device	Bit Address		Word Address		32 bits	Remarks
	English	German	English	German		
Data Block	DB00001.DBX00000.0- DB65535.DBX65533.7		DB00001.DBW00000- DB65535.DBW65532		H/L	*1
Input	I00000.0- I00127.7	E00000.0- E00127.7	IW00000- IW00126	EW00000- EW00126		
Output	Q00000.0- Q00127.7	A00000.0- A00127.7	QW00000- QW00126	AW00000- AW00126		
Internal Marker	M00000.0-M00511.7		MW00000-MW00510			
Timer	-		T00000-T00255			*2
Counter	-		C00000-C00255	Z00000-Z00255		*2

*1 When you write the bit address, the Display reads the word address corresponding to that of the External Device first. Change only the target bit address among the word data once read, and write the word data to the External Device.

Note that the correct data may not be written if you change the word address value in the ladder program while the Display reads the data of the External Device and writes it to the External Device.

*2 Write disable

MEMO

- Please refer to the GP-Pro EX Reference Manual for system data area.
Cf. GP-Pro EX Reference Manual "Appendix 1.4 LS Area (only for direct access method)"
- Please refer to the precautions on manual notation for icons in the table.
 "Manual Symbols and Terminology"

7 Device Code and Address Code

Use device code and address code when you select "Device Type & Address" for the address type in data displays.

7.1 S7-200 Series

Device	Device Name		Device Code (HEX)	Address Code
	English	German		
Variables	V	V	0001	Value of word address divided by 2
Input	I	E	0080	Value of word address divided by 2
Output	Q	A	0081	Value of word address divided by 2
Internal Marker	M	M	0082	Value of word address divided by 2
Timer	T	T	0060	Word Address
Counter	C	Z	0061	Word Address

7.2 S7-300/400 Series

Device	Device Name		Device Code (HEX)	Address Code
	English	German		
Data Block	DB	DB	0000	(Data Block No. x 0x10000) + Value of (word address divided by 2)
Input	I	E	0080	Value of word address divided by 2
Output	Q	A	0081	Value of word address divided by 2
Internal Marker	M	M	0082	Value of word address divided by 2
Timer	T	T	0060	Word Address
Counter	C	Z	0061	Word Address

8 Error Messages

Error messages are displayed on the Display screen as follows: "No.: Device Name: Error Message (Error Occurrence Area)". Each description is shown below.

Item	Description
No.	Error No.
Device Name	Name of the External Device where error occurs. Device name is a title of the External Device set with GP-Pro EX. (Initial value [PLC1])
Error Message	Displays messages related to the error which occurs.
Error Occurrence Area	Displays IP address or device address of the External Device where error occurs, or error codes received from the External Device. MEMO <ul style="list-style-type: none"> • Received error codes are displayed such as "Decimal [Hex]". • IP address is displayed such as "IP address (Decimal): MAC address (Hex)".

Display Examples of Error Messages

"RHAA035: PLC1: Error has been responded for device write command (Error Code: 2 [02H])"

MEMO

- Please refer to the manual of the External Device for more detail of received error codes.
- Please refer to "When an error message is displayed (Error code list)" of "Maintenance/Troubleshooting" for a common error message to the driver.

■ Peculiar Error Message Displayed with GP-ProEX

Message	Description
This version does not support speed higher than 187500 bps. Speed is changed to 187500. Please save the project.	When the project is made with an older driver than Ver.1.01.00 and set transmission rate faster than 187500bps, this error is displayed. The error can be avoided by saving the project.

■ Peculiar Error Message to Driver

Error Code	Error Message	Description
RHxx130	No MPI Token ring detected* ¹	The display does not detect the presence of the token ring. Check Baud Rate settings and cable etc..
RHxx131	Target Node Not Found (PLC%d)	The requested target node is not in the token ring. Verify that the target node number is correct and that the target is connected to the network.
RHxx132	Connection refused	The target node refuses the connection request. The Target External Device resources are full. Too many nodes are connected to this External Device.
RHxx133	Duplicate Node Detected	A duplicated node has been detected on the network. Reassign the node numbers.
RHxx134	Illegal Highest Node	The Highest Node parameter is illegal. Change it to 15/31/63 or 126 numbers.
RHxx135	Illegal Node No.	A Node exists that exceeds the Highest Node Number. Fix the Node number of Highest Node parameter.
RHxx136	MPI Send Error	There was an error during sending data via the MPI H/W feature. Check SIO parameters and Cables etc..
RHxx137	MPI Receive Error	There was an error during the receive of data via the MPI H/W feature. Check the SIO parameters and Cables etc..
RHxx138	Speed setting is wrong(%s). Maximum possible speed is 187500. Please change it and restart the system.	When the old project with higher baud rates is downloaded to AGP, it can not be used with this version. User has to change the baud rate and download the project again. In addition, MPI network baud rates have to be changed (in all PLCs/Devices).
RHxx139	MPI driver can not be used with COM1 and COM2 at the same time	This version can not be used with COM1 and COM2. One of the port has to be removed from the project and download is required.
RHxx140	The driver(in COM%d) can not be used together with MPI.	The other driver used in COM 1 or COM2 can not be used together with MPI direct driver. Other driver has to be removed from the project and project download is required.

*1 When it connects with the S7-200 series in the network where there is not a master device besides Display, it may be displayed.
When this error is displayed more than three seconds, please reset the display device.