

# General Ethernet Driver

1	What is General Ethernet? .....	3
2	System Configuration .....	5
3	Selection of External Device .....	6
4	Example of Communication Setting .....	7
5	Setup Items .....	8
6	Supported Device .....	12
7	Device Code and Address Code .....	13
8	Error Messages .....	14
9	Direct Communication Function .....	16
10	Sample Program .....	25

## Introduction

This manual describes how to connect the Display and the External Device (target PLC).

In this manual, the connection procedure will be described by following the below sections:

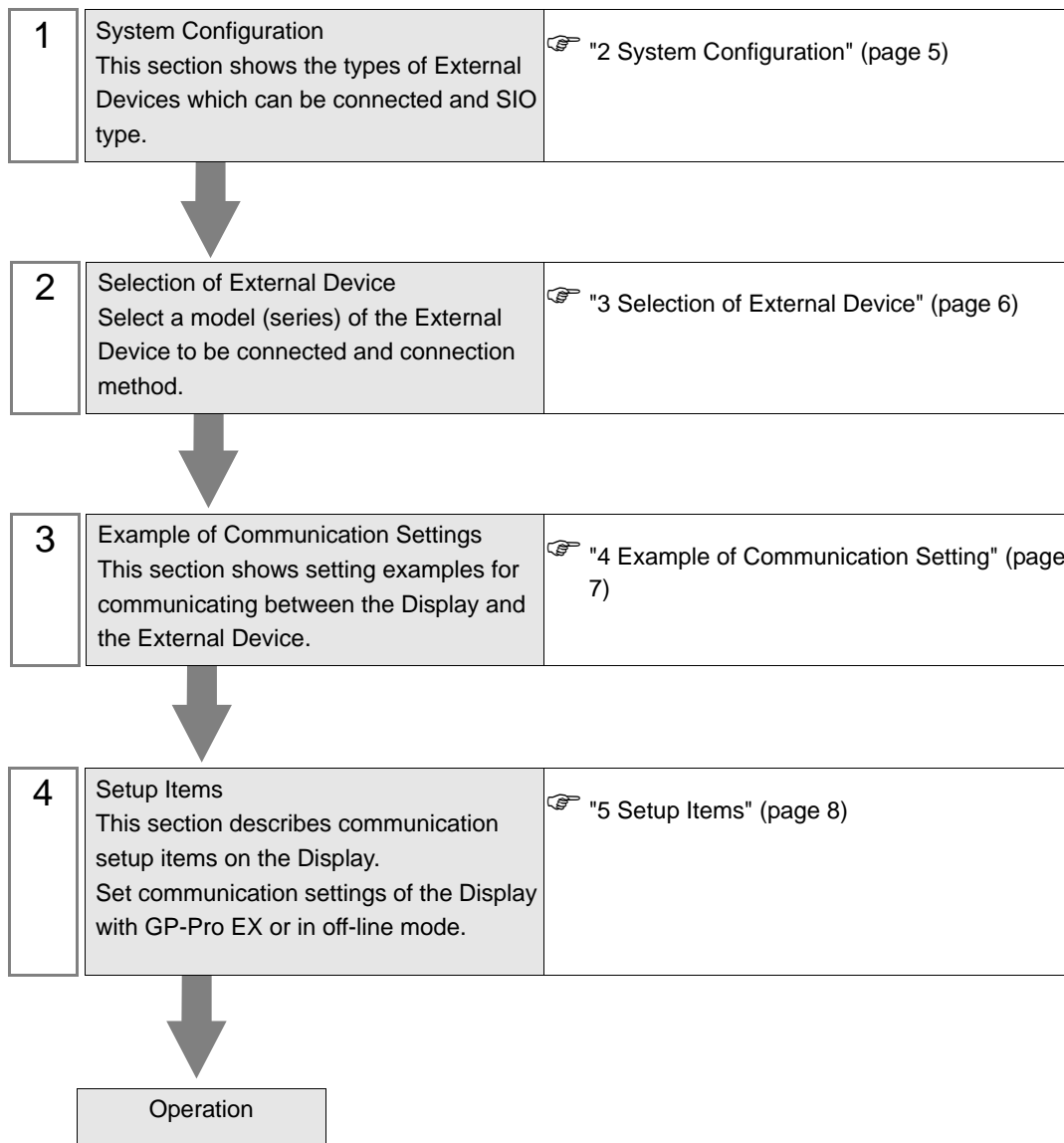

# 1 What is General Ethernet?

## 1.1 Overview

General Ethernet driver is not a special driver corresponding to only the specific Ethernet communications device connected with Display but generally a drivers available

The content of communication packet to be transmitted generates data on the memory table of Display by D script and the ladder program (Hereafter, it is expressed, "Script etc.") of Display. The driver transmits the data generated on the memory table from the Ethernet port of Display, and stores the data received to the Ethernet port of Display in the memory table.

The communication packet is made the Script etc. as above, and this driver enables the data sending and receiving with all the Ethernet communications equipments by mounting only the sending and receiving function to use the Ethernet port.

The communication protocol supports UDP/IP and TCP/IP.

The Ethernet communications device comes by maximum 8 connection in both UDP/IP and TCP/IP.

However, it is Script etc. as for the specification of the destination IP address and port No.. The connection with the communicated device is closed, and work to open the connection to the device at the following connection destination is needed when doing while changing. To close the connection in this method once when communicating with another device, connected the number is not limited.

---

**IMPORTANT** • When use plural driver in one Display, it cannot use with memory link driver by Digital Electronics Corporation.

---

## 1.2 Glossary

Term	Definition and Description
Memory table	Memory table of the Display inside. This driver reads and writes data on this memory table. The system area has a domain of 0000 to 9999 16 bits width.
Script etc.	It is called "Script etc." generically of the function to read and write data on the memory table in this manual. "D script" and "Ladder program" are concretely indicated.
Ring buffer	Ring buffer is a memory area where data is temporarily maintained by the FIFO form. It is called Ring buffer it is possible to read out data to the toroidal. It forms on the memory table of Display in this driver, and it uses it as receiving buffer. To manage the data position in receiving buffer, two pointer of GET pointer and PUT pointer is managed.
GET pointer	GET pointer is a pointer that indicates the place of data in which the Script etc. of the data that should be read next in Ring buffer. The offset value from the first address in the data area of Ring buffer is maintained in this driver. After the data of the area that peels off and , GET pointer indicates is read, GET pointer is advanced to the read position.
PUT pointer	PUT pointer is a pointer that indicates the place of data in which this driver should write the following receive data in Ring buffer. The offset value from the first address in the data area of Ring buffer is maintained in this driver. After writing receive data in the area that PUT pointer indicates, this driver advances PUT pointer to the written position.
Receive function control area	It defines it in a fixed area of the memory table of Display in the area where the administrative information of receiving buffer of this driver was consolidated.
Send function control area	It defines it in a fixed area of the memory table of Display in the area where the administrative information of sending buffer of this driver was consolidated.
System data area	It is an area where system information on Display in the memory table of Display is reflected. A display number of Display and various system information on calendar information etc. can be read and written. It is formed at fixed address (0000 to 0019) in the memory table.
Special relay	It is formed at fixed address (2032 to 2047) in the area in the memory table where Display system information was reflected as well as the system data area.
9000 area	Internal processing information etc. on the indicator like data and the communication scanning time etc. of the past of the line chart are stored. A part of area that can be set exists, too.
User area	They are the areas other than "System data area", "Special relay", and "9000 area" to reflect system information on Display in the memory table of Display. It is a memory area that the user can freely use.

## 2 System Configuration

General Ethernet driver doesn't so need the performance of the communication such as the order terminals, and make device that the communication procedure is easy a target.

### ■ Connection Configuration

- 1:1 Connection

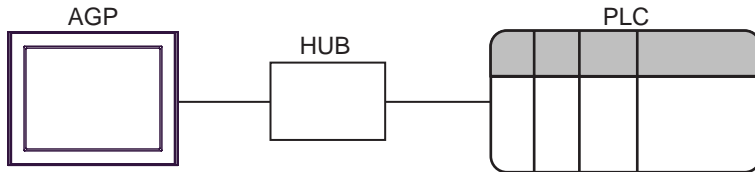

- 1:n Connection

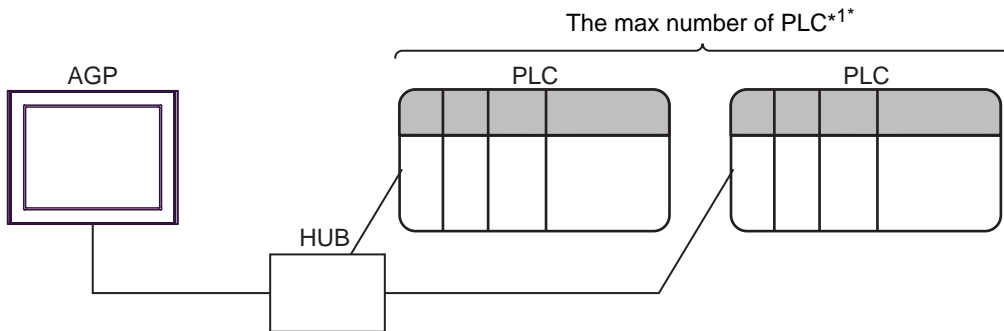

\*1 The Ethernet communications device comes by maximum 8 connection in both UDP/IP and TCP/IP. However, it is Script etc. as for the specification of the destination IP address and port No.. The connection with the communicated device is closed, and work to open the connection to the device at the following connection destination is needed when doing while changing. To close the connection in this method once when communicating with another device, connected the number is not limited.

- n:m Connection

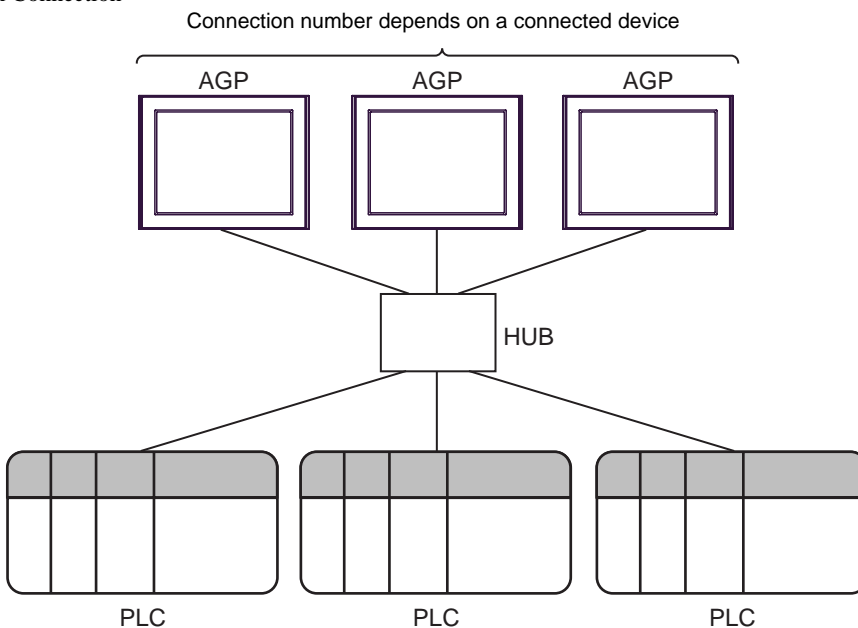

### 3 Selection of External Device

Select the External Device to be connected to the Display.

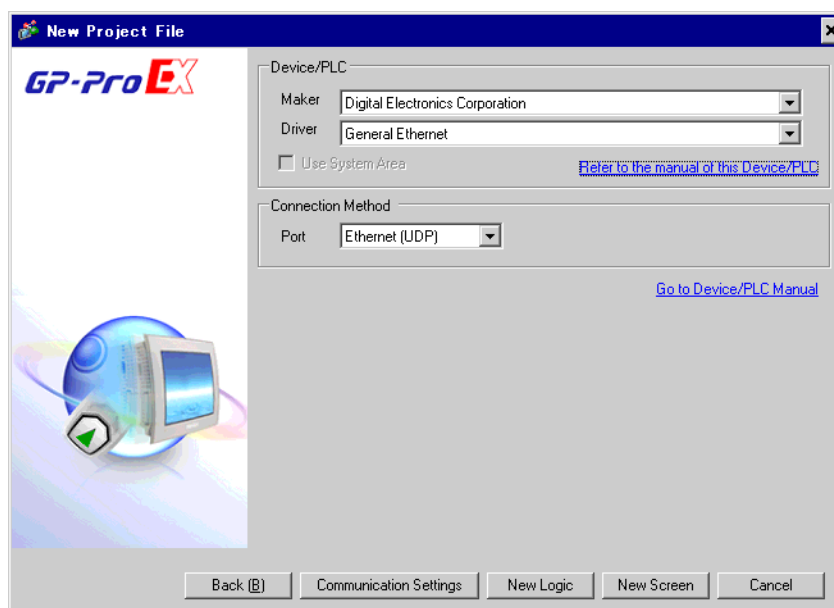

Setup Items	Setup Description
Maker	Select the maker of the External Device to be connected. Select "Digital Electronics Corporation".
Driver	Select a model (series) of the External Device to be connected and connection method. Select "General Ethernet". Check the External Device which can be connected in "General Ethernet" in system configuration. ☞ "2 System Configuration" (page 5)
Port	Select the Display port to be connected to the External Device.

## 4 Example of Communication Setting

Examples of communication settings of the Display and the External Device, recommended by Pro-face, are shown.

### ■ Settings of GP-Pro EX

#### ◆ Communication Settings

To display the setting screen, select [Device/PLC Settings] from [System setting window] in workspace.

#### ◆ Control Area Detail Settings

To display the setting screen, click [Detail] from "No. of Control Area" of [Communication settings window].

**NOTE** • Please refer to "9 Direct Communication Function" about "No. of Control Area" and "Control Area Address".

☞ "9 Direct Communication Function" (page 16)

### ■ Settings of External Device

Communication settings of external device is different by external device to use.

Please refer to the manual of external device for more detail.

#### ◆ Procedure

1 Setup the communication settings of external device as follows.

Setup Items	Setup Description
IP Address	IP Address of External Device
Port No.	Port No. of External Device

## 5 Setup Items

Set communication settings of the Display with GP-Pro EX or in off-line mode of the Display.

The setting of each parameter must be identical to that of External Device.

☞ "4 Example of Communication Setting" (page 7)

- 
- IMPORTANT** • You need to set IP address on the display in the off-line mode of the display.  
Cf. Maintenance/Troubleshooting "2.5 Ethernet Setting"
- 

### 5.1 Setup Items in GP-Pro EX

#### ■ Communication Settings

To display the setting screen, select [Device/PLC Settings] from [System setting window] in workspace.

Setup Items	Setup Description
Port No.	Use an integer from 1024 to 65535 to enter the port No. of the Display. When you check the option of [Auto Assign], the port No. will be automatically set. <b>NOTE</b> • [Auto Assign] option is available to set only when you select "Ethernet (TCP)" in [Connecting Method].
Timeout	Use an integer from 1 to 127 to enter the time (s) for which the Display waits for the response from the External Device.
Wait To Send	Use an integer from 0 to 255 to enter standby time (ms) for the Display from receiving packets to transmitting next commands.
No. of Control Area	Use an integer from 1 to 8 to enter No. of control area.



## ■ Control Area Detail Settings

To display the setting screen, click [Detail] from "No. of Control Area" of [Communication settings window].

The setting item is shown only the number that input in [No. of Control Area] of communication settings.

Setup Items	Setup Description
Control Area Address	Use an integer 20 to 1992 or 2096 to 8152 to enter the address of the control area. <b>NOTE</b> <ul style="list-style-type: none"> <li>Do not set the duplicate address.</li> </ul>
Auto	When the check is put in Auto and the first control area address is input, the control area address since the second is automatically set. When the number of control areas is two or more, Auto is displayed.
IP Address	Set IP address of the External Device. <b>NOTE</b> <ul style="list-style-type: none"> <li>Check with a network administrator about IP address. Do not set the duplicate IP address.</li> </ul>
Port No.	Use an integer 1 to 65535 to enter the port No. of the External Device.

### IMPORTANT

- When "Memory table specification" is specified with "Attribute" of Sending area control area, neither IP address nor the port number set here are used.

☞ " ■ Details of Sending Function Control Area" (page 23)

## 5.2 Setup Items in Off-Line Mode

**NOTE**

- Please refer to Maintenance/Troubleshooting for more information on how to enter off-line mode or about operation.

Cf. Maintenance/Troubleshooting "2.2 Offline Mode"

### ■ Communication Settings

To display the setting screen, touch [Device/PLC Settings] from [Peripheral Settings] in off-line mode. Touch the External Device you want to set from the displayed list.

(First page)

Comm.				
General Ethernet		[UDP]	Page 1/3	
Port No.	<input checked="" type="radio"/> Fixed <input type="radio"/> Auto	<input type="text" value="1024"/> ▼ ▲		
Timeout(s)		<input type="text" value="3"/> ▼ ▲		
Wait To Send(ms)		<input type="text" value="0"/> ▼ ▲		
No. of Control Area		<input type="text" value="2"/> ▼ ▲		
				➔
Exit		Back		2006/11/08 14:35:56

Setup Items	Setup Description
Port No.	Set the Port No. of the Display. In UDP connection, entered port No. will be assigned regardless of whether you select [Fixed] or [Auto]. In TCP connection, select either of [Fixed] or [Auto]. When you select [Fixed], use an integer from 1024 to 65535 to enter the port No. of the Display. When you select [Auto], the port No. will be automatically assigned regardless of the entered value.
Timeout	Use an integer from 1 to 127 to enter the time (s) for which the Display waits for the response from the External Device.
Wait To Send	Use an integer from 0 to 255 to enter standby time (ms) for the Display from receiving packets to transmitting next commands.
No. of Control Area	Use an integer from 1 to 8 to enter No. of control area.

(Since the second page)

Only the number input to the number of control areas sets the first address, IP address, and the port number. Because the control area is allocated from the first, a set content that inputs a number that is larger than the number of control areas is not used.

Comm.				
General Ethernet			[UDP]	Page 2/3
Control Area Address 1		20	▼ ▲	
IP Address	192	168	0 1	
Port No.		2001	▼ ▲	
Control Area Address 2		60	▼ ▲	
IP Address	192	168	0 2	
Port No.		2002	▼ ▲	
Control Area Address 3		100	▼ ▲	
IP Address	0	0	0 0	
Port No.		1024	▼ ▲	
Control Area Address 4		140	▼ ▲	
IP Address	0	0	0 0	
Port No.		1024	▼ ▲	
			← →	
Exit		Back		2006/11/08 14:36:00

Setup Items	Setup Description
Control Area Address	Use an integer 20 to 1992 or 2096 to 8152 to enter the address of the control area. <b>NOTE</b> • Do not set the duplicate address.
IP Address	Set IP address of the External Device. <b>NOTE</b> • Check with a network administrator about IP address. Do not set the duplicate IP address.
Port No.	Use an integer 1 to 65535 to enter the port No. of the External Device.

**IMPORTANT** • When "Memory table specification" is specified with "Attribute" of Sending area control area, neither IP address nor the port number set here are used.  
☞ " ■ Details of Sending Function Control Area" (page 23)

## 6 Supported Device

Range of supported device address is shown in the table below. Please note that the actually supported range of the devices varies depending on the External Device to be used. Please check the actual range in the manual of your connecting equipment.

Device	Bit Address	Word Address	32 bits	Notes
Internal Device	000000 - 999915	0000 - 9999	<b>H/L</b>	

---

**IMPORTANT**

- This driver corresponds only to an internal device.
  - The system data area becomes a memory link method.
  - The range that can be used in the control area is 20-2031 and 2096-8191.
- 

**NOTE**

- Please refer to the precautions on manual notation for icons in the table.

 "Manual Symbols and Terminology"

---

## 7 Device Code and Address Code

Use device code and address code when you select "Device Type & Address" for the address type in data displays.

Device	Device Name	Device Code (HEX)	Address Code
Internal Device	-	0000	Word address

## 8 Error Messages

Error messages are displayed on the screen of Display as follows: "No. : Device Name: Error Message (Error Occurrence Area)". Each description is shown below.

Item	Description
No.	Error No.
Device Name	Name of External Device where error occurs. Device name is a title of External Device set with GP-Pro EX.((Initial value [PLC1])
Error Message	Displays messages related to the error which occurs.
Error Occurrence Area	Displays IP address or device address of External Device where error occurs, or error codes received from External Device. <div style="border: 1px solid black; padding: 2px; display: inline-block;"><b>NOTE</b></div> <ul style="list-style-type: none"> <li>• IP address is displayed such as "IP address (Decimal): MAC address (Hex)".</li> <li>• Device address is displayed such as "Address: Device address".</li> <li>• Received error codes are displayed such as "Decimal [Hex]".</li> </ul>

Display Examples of Error Messages

"RHAA035: PLC1: Error has been responded for device write command (Error Code: 2 [02])"

**NOTE**

- Please refer to the manual of External Device for more detail of received error codes.
- Please refer to "When an error message is displayed (Error code list)" of "Maintenance/Troubleshooting" for a common error message to the driver.

### ■ Error Messages Peculiar to Driver

The error code peculiar to this driver is as follows.

Message ID	Error Message	Description
RHxx128	(Node Name):UDP/IP:It is not completed to open the socket	It is displayed that data is transmitted before the socket is opened.
RHxx129	(Node Name):TCP/IP:It is not completed to open the connection	It is displayed that data is transmitted before the connection is opened.
RHxx130	(Node Name):TCP/IP: Cannot open passive connection with PortAuto setting	When the exchange number title was set with TCP automatically, it opened passively.
RHxx131	(Node Name): An error occurred in protocol stack(Code:%02XH)	When the error occurs by the protocol stack, it is displayed.
RHxx014	(Driver Name):The driver Memory Link and General Ethernet can not be used at the same time	When General Ethernet driver and Memory Link driver are used at the same time, it is displayed.

## ■ Error Code of Protocol Stack

Error Code of Protocol Stack is shown below. As for the error code for the internal setting stored in each control area, the value in which 0x1000 is done to the error code for the following display in OR is set.

Error code for display	Error code for internal setting	Description
<No display>	0000	Normal (It is not displayed to a screen in normalcy.)
00	1000	It is IP address setting error in the initialization
05	1005	It failed initialization
06	1006	It failed in the communication discontinuance processing.
07	1007	It tried to establish the connection with initialization had not ended normally
08	1008	Source port No. error
09	1009	Destination port No. error
0A	100A	Destination IP address error
0B	100B	The same port number has already been used in UDP/IP
0C	100C	The connection has already been established in TCP/IP by the same number as the same destination
0D	100D	Protocol stack refused open processing
0E	100E	Protocol stack failed in open processing
0F	100F	Connection was cut off
10	1010	All connections are used, and there is not a space connection
13	1013	It was aborted by the destination
30	1030	There is not an answer from a protocol stack
32	1032	There is not an answer from the destination
F0	10F0	Undefined error

## 9 Direct Communication Function











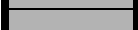

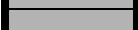

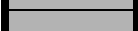

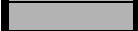

This driver supports the function to communicate by way of Ethernet by making data for the memory table of Display with Script etc. of Display. This is called "Direct Communication Function".

### 9.1 Memory Table

The map of Memory Table of Display is shown below.

 : It is an area that this protocol uses. To support two or more connections at the same time, this eight areas or less are maintained.

a: Initial address of control area

0		: System data area
19		Cf. GP-Pro EX Reference Manual "Appendix 1.5 System Area (Memory Link Area)"
20		: User area
a+0		Receive function control area
a+1		 "9.2 Receive Function Control Area" (page 17)
a+2		
a+3		
a+4		
a+5		
a+6		
a+19		
a+20		Send function control area
a+21		 "9.3 Send Function Control Area" (page 21)
a+22		
a+23		
a+24		
a+25		
a+26		
a+27		
a+28		
a+29		
a+39		
		: User area
2031		
2032		: Special relay
		Cf. GP-Pro EX Reference Manual "Appendix 1.5 System Area (Memory Link Area)"
2047		
2048		: Reservation area
2095		
2096		: User area
8999		
9000		: 9000 area
		Cf. GP-Pro EX Reference Manual "Appendix 1.5 System Area (Memory Link Area)"
9999		



## 9.2 Receive Function Control Area

This driver receives data from the Ethernet communications device, and stores data in receiving buffer.

This receiving buffer can be formed with an arbitrary size at an arbitrary address in the Display memory table.

These receiving buffer is defined, and the area to handle the received data is called "Receive Function Control Area". This Receive Function Control Area is formed at the specific address position (a+9 to a+19) of the memory table address of Display shown in the following fixing.

a: Initial address of control area

☞ " ■ Details of Receive Function Control Area" (page 19)

a+0		: Receive function control (0: Function stop, 1: Processing execution)
a+1		: Receiving result (0: Normal, 1: Error)
a+2		: Receiving ring buffer initial memory table address
a+3		: Number of receiving ring buffer words
a+4		: GET pointer (Offset value from buffer head)
a+5		: PUT pointer (Offset value from buffer head)
a+6		
a+19		

Receiving buffer that stores receive data is defined by using this Receive Function Control Area. In general, Display sets this definition immediately after the start.

GET pointer (a+4) shows the first address of the memory table to write the data that Display received in receiving buffer. PUT pointer (a+5) shows the first address of the memory table to write the data that Display received in receiving buffer. When offset value (0 to) from the first address of receiving buffer formed with the above-mentioned is maintained, and it reaches the size defined as receiving buffer, the GET pointer and the PUT pointer are set to 0 again.

Receive function control word (a+0) is the one that taking data from receiving buffer of Display to receiving ring buffer is controlled. When receive function control word is a+0, the reception processing is stopped, and it is not processed to receiving ring buffer from receiving buffer of Display to take it of data. When receive function control word is a+1, the content of data that Display received is taken into receiving ring buffer.

## ■ Receiving Buffer

The PUT pointer shows the writing position of the following receive data with the pointer that the Display side controls.

Receiving buffer is formed to the following, and the state to have received the data is shown. The ring buffer is formed from a+50 in the memory table address with six words, and the state to receive two bytes ("A", "B") is shown in the figure below.

The receive function of Display stores receive data at the PUT pointer position every time one byte is received. Script etc. reads out data from the position of the GET pointer, and advances the GET pointer to the extent that it reads it. Receive data is stored in the subordinate position byte of each address of the memory table (Word: 16bit length) every one byte.

The PUT pointer shows the writing position of the following receive data with the pointer that the Display side controls.

After it reaches final address (a+55) of receiving buffer, storage at first address (a+50) is tried again. However, the position of the GET pointer is never exceeded (There is not overwriting data in the place where reading is not completed). Therefore, the received data is Script etc. Therefore, after it reads it with Script etc., the received data should appropriately advance the GET pointer. When the state that receive data cannot be written in receiving buffer without renewing the GET pointer continues, the receiving buffer overflow of Display might be generated.

Example) When assume the initial address in the control area to be 1900

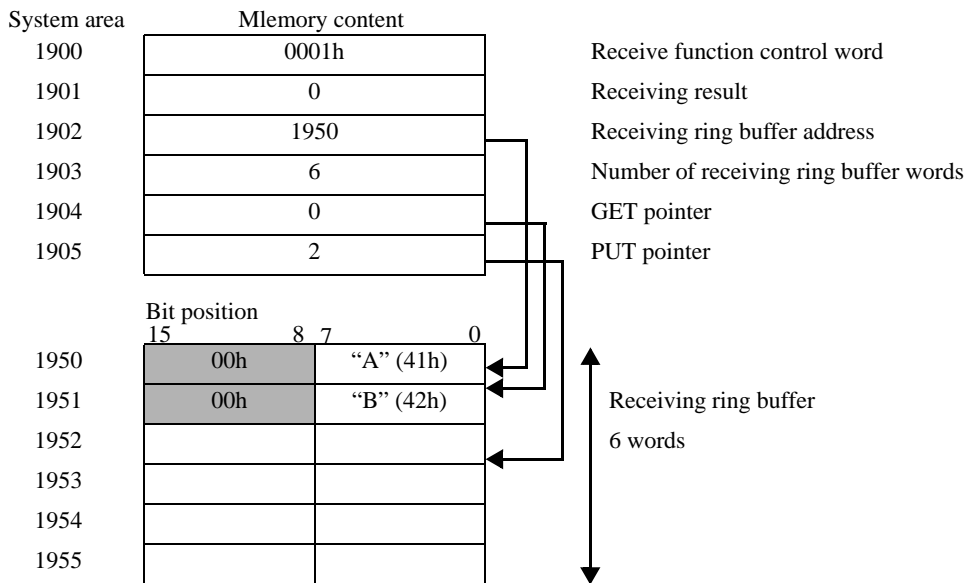

\*Receive data is stored by the subordinate position byte of each address of the memory table (word) in one byte.

## ■ Details of Receive Function Control Area

a: Initial address of control area

System area address	Name	Update responsibility*1 (Trigger)	Description
a+00	Receive function control word	Script etc.	0: Function stop The reception function is stopped. 1: Reception permission Data is stored from receiving buffer of Display to receiving ring buffer. It updates it with Script etc.
a+01	Receiving result	Display	The error code of the protocol stack generated by each processing of the opening, the close, and the reception is reflected. 0: Normal end Excluding 0: Error Script etc. writes 0 in this area after the error is confirmed, and receives the following data. ☞ " ■ Error Code of Protocol Stack" (page 15)
a+02	Receiving ring buffer initial memory table address	Script etc.	The first memory table address of receiving ring buffer is set. It sets it to user's areas except a system data area, a special relay, and 9000 area, etc. though it is possible to set on an arbitrary memory table address.
a+03	Number of receiving ring buffer words	Script etc.	The number of words for receiving buffer is set. (It agrees to the number of bytes that can be received with it with the number of words set here.) A number of words consecutive from the above-mentioned first address is specified.
a+04	GET pointer	Script etc.	Next, the address position of the receive data that should be read is pointed at, and offset value (0 to) from the first address of receiving ring buffer is maintained. Script etc. acquires data from the position of this pointer, and updates the position of this pointer afterwards.
a+05	PUT pointer	Display	The position in which the data that Display received to receiving buffer is written is pointed at, and offset value (0 to) from the first address of receiving ring buffer is maintained. Whenever Display receives the data, this pointer is automatically renewed.
a+06	Reception former IP address	Script etc.	Reception former IP address (Upper 16 bits). It uses it to specify the passive opening, and the connection destination.
a+07	Reception former IP address	Script etc.	Reception former IP address (Lower 16 bits). It uses it to specify the passive opening, and the connection destination.
a+08	Reception former port No.	Script etc.	Reception former port No. It uses it to specify the passive opening, and the connection destination.
a+09	Reserved		
:	Reserved		
a+19	Reserved		

- \*1 To operate this function appropriately, the sharing of responsibility of the data update is shown.  
Display: Display does.  
Script etc.: It is necessary to do with Script etc. that uses this function.

---

**IMPORTANT**

- Sending buffer, other Display system data areas, etc. and the definition areas must note not coming in succession about receiving buffer. It causes the defective operation when defining it with the area came in succession.
-

### 9.3 Send Function Control Area

To transmit data to the Ethernet telecommunications equipment, this driver has sending buffer that temporarily stores transmission packet. This sending buffer can be formed with an arbitrary size at an arbitrary address in the Display memory table. These sending buffer is defined, and the area to handle the transmitted data is called "Send Function Control Area". This Send Function Control Area is formed at specific address position (a+20 to a+39) of the memory table address of Display shown in the following fixing.

a: Initial address of control area

 " ■ Details of Sending Function Control Area" (page 23)

a+20		: Send function control word (0: Function stop, 1: Processing execution)
a+21		: Sending result (0: Normal, 1: Error)
a+22		: Sending buffer initial memory table address
a+23		: Number of sending data bits
a+24		: Attribute
a+25		: Reserved
a+26		: Destination IP address (Upper 16 bits)
a+27		: Destination IP address (Lower 16 bits)
a+28		: Destination port No.
a+29		
a+39		

The transmission data that tries to be transmitted to Ethernet is stored in sending buffer once. Afterwards, the content of data in the buffer is transmitted from Ethernet by executing the transmission.

After the first address of sending buffer is set to sending buffer first memory table address (a+22), and the transmission data is stored in the set buffer, number (a+23) of transmission databytes is set. When one is written in send function control word (a+20) after making transmission packet is completed, transmission packet is transmitted by way of Ethernet.

After executing each processing, send function control word automatically becomes 0.

#### IMPORTANT

- Even if one is written in send function control word when it is the following, packet is not transmitted.
- When the range in the control area exceeds address 8192
- When excess of address 8192 by "Number of words for receiving ring buffer first address + receiving ring buffer".
- When excess of address 8192 by "Sending buffer first address + number of transmission databytes".
- When the GET pointer or the PUT pointer exceeds receiving ring buffer end.

## ■ Sending Buffer

Sending buffer is formed to the following, and the state to transmit data is shown.

It is a in the memory table address as for sending buffer + It forms with 60, and the state to transmit three bytes ("A", "B", "C") is shown in the figure below.

Sending buffer stores data from the specified first address, and specifies bite-sized that stores the data length (occupation memory table area size). To store data in every one byte in the subordinate position byte of one word of the memory table, byte size becomes the number of occupation words of memory tables.

Example) When assume the initial address in the control area to be 1900

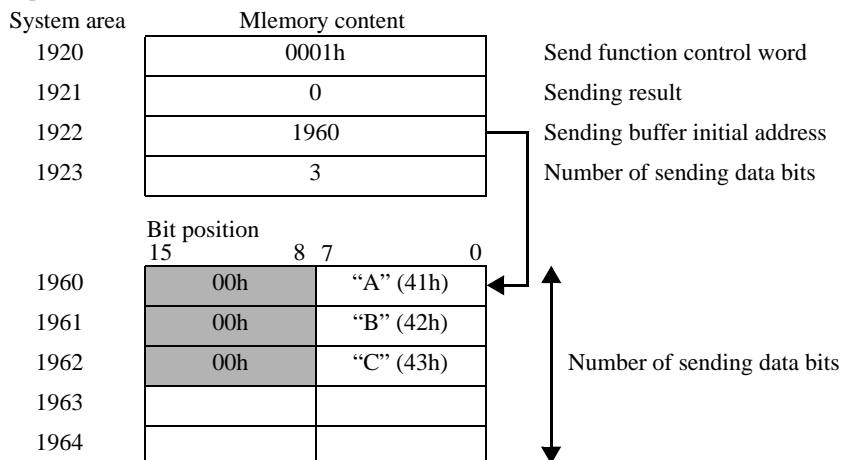

\*Please store the transmission data in the subordinate position byte of each address of the memory table (word) in one byte.

## ■ Details of Sending Function Control Area

a: Initial address of control area

System area address	Name	Update responsibility *1 (Trigger)	Description
a+20	Send function control word	Script etc.	<p>0: Function stop (or processing completion) The send function is stopped. After completing the following processing, Display resets this area value in 0.</p> <p>0x0001: The content of the sending buffer is transmitted by way of Ethernet.</p> <p>0x0002: The port is opened to specified destination IP address according to the setting of attribute (a+24). TCP: Open the TCP connection. UDP: Open the UDP socket.</p> <p>0x0004: Open the connection TCP: Close the TCP connection. UDP: Close the UDP socket.</p> <p>*Transmission procedure</p> <ol style="list-style-type: none"> <li>Setting the 0x0002, and open the connection/socket.</li> <li>Setting the 0x0001, and the content of sending buffer is transmitted.</li> <li>Setting the 0x0002, and close the connection/socket.</li> </ol>
a+21	Sending result	Display	<p>The error code of the protocol stack generated by the transmission processing is reflected.</p> <p>0: Normal end</p> <p>Excluding 0: Error 0 is written in this area after the error is confirmed, and Script is assumed that the following data is transmitted.</p> <p> " ■ Error Code of Protocol Stack" (page 15)</p>
a+22	Sending buffer initial memory table address	Script etc.	<p>The first memory table address of sending buffer is set. Please set it to user's areas except system data area and a special relay, etc. though it is possible to set to the memory table of arbitrary Display.</p>
a+23	Number of sending data bits	Script etc.	<p>The number of words for sending buffer is set. (Please set the number of bytes stored in sending buffer to the value set here. )</p>

System area address	Name	Update responsibility *1 (Trigger)	Description
a+24	Attribute	Script etc.	Setting the communication style. <ul style="list-style-type: none"> <li>• Bit 0: Destination IP designation settings 0: U/I designation 1: Memory table designation</li> <li>• Bit 1: Destination port No. designation settings 0: U/I designation 1: Memory table designation</li> <li>• Bit 2: Connection method designation settings 0: U/I designation 1: Memory table designation (Refer to Bit 3)</li> <li>• Bit 3: Connection method 0: TCP/IP 1: UDP/IP</li> <li>• Bit 4: Open form 0: Active opening 1: Passive opening</li> <li>• Bit 5: Automatic opening 0: No automatic opening. 1: Automatic opening</li> <li>• Bit 6 to 15: Undefined</li> </ul>
a+25	Reserved		Reserved
a+26	Destination IP address	Script etc.	Destination IP address (Upper 16 bits)
a+27	Destination IP address	Script etc.	Destination IP address (Lower 16 bits)
a+28	Destination port No.	Script etc.	Destination port No.
a+29	Reserved		
:	Reserved		
a+39	Reserved		

\*1 To operate this function appropriately, the sharing of responsibility of the data update is shown.  
 Display: Display does.  
 Script etc.: It is necessary to do with Script etc. that uses this function.

**IMPORTANT**

- Receiving buffer, other Display system data areas, etc. and the definition areas must note not coming in succession about sending buffer. It causes the defective operation when defining it with the area came in succession.
- When check “automatic allocation” of the port number, TCP passive opening cannot be used.



## 10 Sample Program

The example of the sending and receiving procedure and the sample script are shown as follows.

<System configuration>

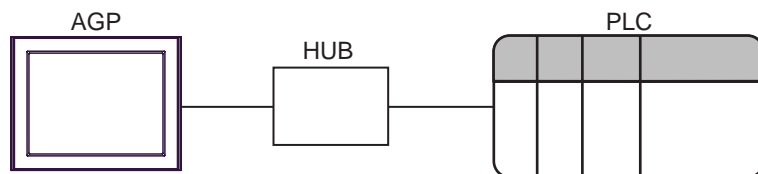

<Program overview>

It communicates in the sample program as follows.

1. Data (ABC) of three bytes is transmitted to connected equipment.
2. Two bytes of the transmitted data are received.

<Example of transmission and reception procedure>

The example of the procedure when the command is transmitted from AGP to External Device, and the response is received from connected equipment is shown below.

1. Receive function control area settings
  - (1) Receiving result clear
  - (2) Receiving ring buffer initial address settings
  - (3) Number of receiving ring buffer words settings
  - (4) The gap of GET pointer and PUT pointer is corrected. (Because it becomes garbage data.)
  - (5) Receive function control word settings (0x0001: Reception permission)
2. Send function control area settings
  - (1) Sending result clear
  - (2) Sending buffer initial address settings
  - (3) Attribution settings (IP address, port No. and transmission system settings)
  - (4) Send function control word settings (0x0002: Connection open of TCP or socket open of UDP)<sup>\*1</sup>
3. Creation and transmission of sending data
  - (1) Create the sending data
  - (2) Number of sending data bite setting
  - (3) Send function control word settings (0x0001: Transmission of command)
4. Reception processing of data
  - (1) The reception data is removed from the receiving ring buffer. (advancing the GET pointer)
5. Send function control area settings
  - (1) Send function control word settings (0x0004: Connection close of TCP or socket close of UDP)

\*1 When it has made automatic operation opening with setting of attribute (a+24), this procedure is unnecessary.

<Sample script>

Below, " ■ Receiving Buffer" (page 18) and " ■ Sending Buffer" (page 22) being similar, it shows the sample script which it makes on the basis of a state where you have listed.

Control area first address is designated as 1900, the memory map which has been used is listed below.

Address	Memory content	
1900	0001h	Receive function control word
1901	0	Receiving result
1902	1950	Receiving ring buffer initial address
1903	6	Number of receiving ring buffer words
1904	0	GET pointer
1905	2	PUT pointer
:	:	
1920	0000h	Send function control word
1921	0	Sending result
1922	1960	Sending buffer initial address
1923	3	Number of sending data bite
1924	0x07	Attribution (Active Open / TCP / Other Script etc. setting)
1925		
1926	0xC0A8	Destination IP address (Upper 16 bits: 192.168)
1927	0x0101	Destination IP address (Lower 16 bits: 1.1)
1928	1025	Destination port No. (1025)
:	:	
	Bit position	
	15 8 7 0	
1950	00h "A"(41h)	Receiving ring buffer
1951	00h "B"(42h)	6 Words
1952		
1953		
1954		
1955		
:	:	
	15 8 7 0	
1960	00h	Sending buffer
1961	00h	
1962	00h	
1963		
1964		
:	:	
2000	0	Processing state storage memory
2001	0	Number of receiving bite storage memory
2002		
2003		
2004		

## 1. Open process (Receive function control area settings)

- Trigger condition

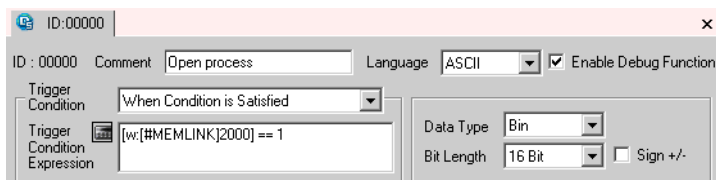

- Execution formula

```
// Initialize the control area, connection open process

// Receive function control area settings -----
[w:[#MEMLINK]1901] = 0           // Receiving result clear
[w:[#MEMLINK]1902] = 1950       // Receiving buffer initial address
[w:[#MEMLINK]1903] = 6          // Number of receiving buffer words
[w:[#MEMLINK]1904] = 0          // GET pointer clear
[w:[#MEMLINK]1905] = 0          // PUT point clear

// Reception permission
[w:[#MEMLINK]1900] = 1          // Receive control word reception permission

// Send function control area settings -----
[w:[#MEMLINK]1921] = 0          // Sending result clear
[w:[#MEMLINK]1922] = 1960       // Sending buffer initial address

// Attribution settings
[w:[#MEMLINK]1924] = 0x07       // b4:0(Active open) b3:0(TCP communication) b2:1(Transmission
                                // system)
                                // b1:1(Destination port No.) b0:1(Destination IP address)

// Destination IP address and port No. settings
[w:[#MEMLINK]1926] = 0xC0A8     // 192.168
[w:[#MEMLINK]1927] = 0x0101     // 1.1
[w:[#MEMLINK]1928] = 1025       // port No.

// Connection open-----
[w:[#MEMLINK]1920] = 2          // Sending control word connection open

// Completion of opening is set to memory -----
[w:[#MEMLINK]2000] = 2          // Complete the open
[w:[#MEMLINK]2001] = 0          // Receiving data storage point clear
```

## 2. Send process (Creation and transmission of sending data)

- Trigger condition

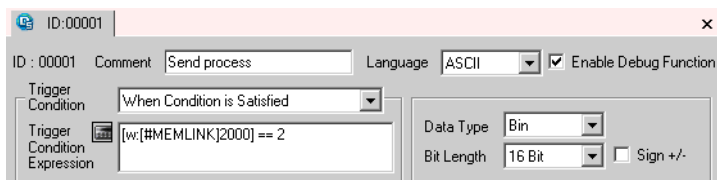

- Execution formula

```
// Packet compilation and transmission processing

//Compilation of packet -----
[w:[#MEMLINK]1960] = 0x41      // 'A'
[w:[#MEMLINK]1961] = 0x42      // 'B'
[w:[#MEMLINK]1962] = 0x43      // 'C'

// Setting the number of transmission bytes
[w:[#MEMLINK]1923] = 3          // 3 byte transmission

// Transmission of packet -----
[w:[#MEMLINK]1920] = 1          // Send control word data transmission

// Completion of transmission is set to memory -----
[w:[#MEMLINK]2000] = 3          // Completion of transmission
```

## 3. Receive process (Reception processing of data)

- Trigger condition

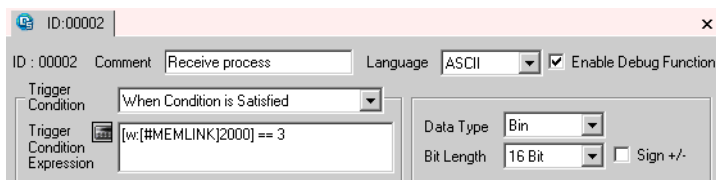

- Execution formula

```
// Reception processing

if( [w:[#MEMLINK]1904] <> [w:[#MEMLINK]1905] )
{ // Check the GET pointer and PUT pointer. If it differs, there is a reception data.
[t:0000] = [w:[#MEMLINK]1903] // Reception buffer size amount loop
[t:0001] = [w:[#MEMLINK]2001] // Receiving data storage point clear

loop([t:0000])
{
// Check the GET pointer and PUT pointer. If it is the same, completion of acquisition.
if( [w:[#MEMLINK]1904] == [w:[#MEMLINK]1905] ) {
break
}endif
[t:0002] = [w:[#MEMLINK]1904] // GET pointer acquisition

// Acquiring the data
[w:[#MEMLINK]3000]#[t:0001] = [w:[#MEMLINK]1950]#[t:0002]

// The position where store/acquire the data the increment
[t:0001] = [t:0001] + 1
[w:[#MEMLINK]1904] = [w:[#MEMLINK]1904] + 1
if( [w:[#MEMLINK]1904] >= [w:[#MEMLINK]1903] ) {
[w:[#MEMLINK]1904] = 0
}endif
}
endloop

// Check the acquire data of expected bytes (2 bytes)
if( [t:0001] >= 2 ) {
// Completion of reception is set to memory -----
[w:[#MEMLINK]2000] = 4 // Completion of reception
[w:[#MEMLINK]2001] = 0 // Reception data storage position clearing
} else {
// It meaning that the data inside receiving buffer midway, it turns to next processing -----
[w:[#MEMLINK]2001] = [t:0001]
}endif
}
endif
```

## 4. Close process (Reception processing of data)

- Trigger condition

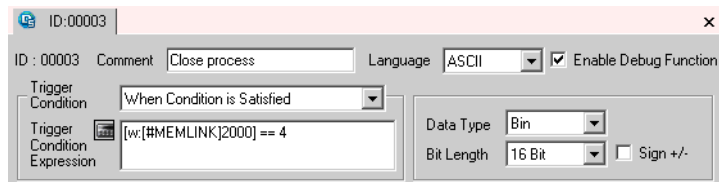

- Execution formula

```
// Connection close process

// Close the connection -----
[w:[#MEMLINK]1920] = 4 // Sending control word close

// Completion of close processing is set to memory -----
[w:[#MEMLINK]2000] = 0 // Cpmplete the close
```