

**Digital**  
*Human Machine Interface* —

**Pro-face®**

# GP-H70 Series User Manual

**Digital**  
Digital Electronics Corporation

---

## Preface

---

Thank you for purchasing the Pro-face® GP-H70, one of the Digital Electronics Corporation's series of Graphic Control Panels (hereafter referred to as the GP-H70 unit).

Please read this manual carefully as it explains, step by step, how to use the GP's functions and features correctly.

- The Digital Electric Corporation's GP-H70 series of display panels includes the following devices.

GPH70-SC11-24V, GPH70-LG11-24V (Standard Units)

GPH70-SC41-24V, GPH70-LG41-24V (Comply with CE/UL regulations)

- Digital's GPH70-LG41-24V and GPH70-SC41-24V panels are CE-marked products that conform to EMC Directives, EN55022 Class A and EN50082-2.



1. It is forbidden to copy the contents of this manual, either in whole or in part, except for the purpose of the user's personal use, without the express written permission of the Digital Electronics Corporation of Japan.
2. The information provided in this manual is subject to change without notice.
3. This manual has been written with care, however, should the user discover any errors or omissions, please contact the Digital Electronics Corporation and inform them of your findings.
4. Please be aware that the Digital Electronics Corporation is not responsible for any damages resulting from the use of its products, regardless of article 3 above.

All company or manufacturer names used in this manual are the registered trademarks of their respective companies.

© Copyright 1998, Digital Electronics Corporation

MS-DOS® and Windows®95 are registered trademarks of the Microsoft Corporation.

IBM® DOS® are registered trademarks of IBM.

This CE-marked unit's Push-Lock switch's design differs from that of the standard model.

---

## **Safe Product Usage**

---

This manual contains a variety of safety markings to help you safely and correctly operate Digital's GP-H70 Graphic Control Panel.

Be sure to keep this manual handy for future reference.

### **■ Safety Icons**

This manual uses the two icons below to call attention to information important for the safe and correct use of the GP. Please pay attention to these icons and follow all instructions given by them.

#### **The safety icons and their meanings are:**



Indicates a potentially hazardous situation which could result in serious injury or even death, if the instructions are not followed.



Indicates a potentially hazardous situation which could result in minor injury or equipment damage if the instructions are not followed.



## Essential Safety Precautions

For the safe and correct use of this unit, be sure to follow the guidelines stated below:

- Due to the possibility of an electrical shock, be sure the Power Cord is not plugged in to a power supply when first connecting the Power Cord's power terminals to the GP-H70.
- Because the GP-H70 contains high voltage parts, an electrical shock can occur if the user tries to disassemble the unit. The GP-H70 should be disassembled only by an authorized serviceman.
- Do not use power which is outside of the specified voltage range. Doing so may cause a fire or an electric shock.
- Do not attempt to modify or alter the GP-H70 unit. Doing so may cause a fire or an electric shock.
- Do not use the GP-H70 in an environment that contains flammable gases, since it may cause explosion.
- The GP-H70 uses a lithium battery to back up its internal clock data. If this battery is incorrectly replaced, however, it may explode. To prevent this, be sure to consult with your local GP-H70 distributor before changing this battery.
- Do not use this unit's touch panel keys to perform any life-threatening or accident-prevention operations (i.e. as an Emergency Stop switch, etc.) Be sure to use separate hardware switches for such operations.
- Please design your machine's control system so that it will not malfunction due to a communication fault between the GP-H70 and the host controller (PLC).

If this is not done, there is a danger of either personal injury or machinery/material damage.



## **General Safety Precautions**

---

To Avoid Damaging the GP-H70:

- Do not strike or hit the touch panel with either hard or heavy objects, or push the touch panel's face with too much force.
- Storing or operating the GP-H70 in environments with temperatures outside the specified allowable ranges may cause the unit to break down.
- Do not allow water, liquids, or metal particles to enter the GP-H70's case, since it can cause a malfunction or electrical shock.
- Avoid operating the GP-H70 in locations where sudden temperature changes can cause condensation to form inside the unit, since this can cause the unit to malfunction.
- Avoid restricting the GP-H70's naturally occurring ventilation, or storing or operating the GP-H70 in an environment that will cause it to become overheated.
- Avoid storing or operating the GP-H70 in either direct sunlight or in excessively dusty or dirty environments.
- Because the GP-H70 is a precision instrument, do not store or use it in locations where excessive jolting or vibration can occur.
- Do not store or operate the GP-H70 where chemicals and acids are either stored or where high concentrations of fumes are present. The GP-H70 may either malfunction or be damaged as a result.
- Do not use paint thinner or organic solvents to clean the GP-H70's case or display.
- Due to the danger of unforeseen accidents, be sure to back up all screen data regularly.

---

## Notes on the GP-H70 Display

---

- The type of display data shown on the GP-H70's screen and the unit's current contrast level may affect the intensity of Contouring. (i.e. when certain parts of the screen are brighter than others, creating a wave-like pattern)
- The small grid-points on the Display Panel surface are the panel's normal design and are not a defect.
- Shadows may appear at the top of the LCD's border.
- A color will look different when viewed from an angle outside the screen's specified view angle. This is normal.
- Displaying a single image for long periods can cause an afterimage to remain after changing to another screen.
- To prevent these afterimages, follow the instructions below:



- When the same screen will be displayed for a long period of time, use the Display OFF function (for further information about this function, refer to *Chapter 5, "INITIALIZE"*).
- Do not display any single screen for a long period of time. Change the screen display periodically.

---

## Notes on UL Applications

---

The GPH70-LG41-24V and GPH70-SC41-24V are (c)UL 1950 (+ D3) recognized products. (UL File No. E171486). Please pay special attention to the following instructions when applying for UL approval for machinery which includes one of these GP units.

- GP conforms as a component to the following standards:
  - UL 1950 (+ D3), Second Edition, dated February 26, 1993 (Standard for Safety of Information Technology Equipment, including Electrical Business Equipment)
  - CAN/CSA-C22.2 No. 950-M89 (+D3) (Standard for Safety of Information Technology Equipment, including Electrical Business Equipment)The D3 deviations are: SC1.3.4, SC1.3.8, SC2.1, SC2.9, and SC5.3. These deviations will lose effect on March 15, 2000.

GPH70-LG41-24V (UL Registration Model: 0980011-02)

GPH70-SC41-24V (UL Registration Model: 0980011-01)

- Machinery with a GP mounted in it requires UL inspection for the combination of the GP and the machinery.
- GP mounted machinery will also be treated as having the D3 deviations.
- The electric power must be supplied by ELV circuit that complies with Sub-clause 1.3.8 in the UL1950 Standard, or from a limited power source which fulfills condition C1 and 2.11.
- If the GP is installed so as to cool itself naturally, be sure to install the GP in a vertical position. Also, be sure that the GP is installed so that it is at least 100mm away from any adjacent structures or devices. If these requirements are not met, the heat generated by the GP's internal components may cause the unit to fail to meet UL standard requirements.

---

# Table of Contents

## Preface

Preface .....	v
Safe Product Usage.....	i
Essential Safety Precautions .....	ii
General Safety Precautions .....	iii
Notes on UL Applications .....	vi
Table of Contents .....	vii
Package Contents .....	x
Symbols .....	xi

## Chapter 1 Introduction

1-1 Prior to Operating the GP-H70 .....	1-1
1-2 System Design .....	1-2
1-3 Optional Equipment .....	1-3

## Chapter 2 Specifications

2-1 General Specifications .....	2-1
2-1-1 Electrical Specifications .....	2-1
2-1-2 Environmental Specifications .....	2-1
2-1-3 Other Items .....	2-2
2-2 Functional Specifications .....	2-3
2-2-1 Display Features .....	2-3
2-2-2 Screen Memory .....	2-3
2-2-3 Touch-Panel/Switches.....	2-4
2-2-4 External Interface .....	2-4
2-3 Interface Specifications .....	2-5
2-3-1 Serial Interface .....	2-5
2-4 Names and Functions of GP Parts .....	2-9
2-5 GP Dimensions .....	2-12
2-5-1 GP-H70 External Dimensions .....	2-12
2-5-2 GP-H70 Installation Bracket (Created by User) .....	2-13
2-5-3 Hanging the GP-H70 on a Wall .....	2-14



---

## **Chapter 3 Installation and Wiring**

3-1	Wiring .....	3-1
3-1-1	Connecting the GP-H70's Power Cable .....	3-1
3-1-2	Precautions: Grounding .....	3-1
3-2	Tool Connector .....	3-2

## **Chapter 4 OFFLINE Mode**

4-1	Using OFFLINE Mode .....	4-1
4-1-1	Entering OFFLINE Mode - After Start-Up .....	4-1
4-1-2	Entering OFFLINE Mode - From Forced Reset Screen .....	4-2
4-2	Main Menu Screen .....	4-4
4-3	INITIALIZE Functions .....	4-5
4-4	SELF-DIAGNOSIS Functions .....	4-7
4-5	Transferring Screen Data .....	4-9

## **Chapter 5 INITIALIZE**

5-1	Prior To Entering Initial Data .....	5-1
5-2	INITIALIZE Menu Items .....	5-2
5-3	SYSTEM ENVIRONMENT SETUP .....	5-3
5-3-1	SYSTEM SET UP .....	5-3
5-3-2	SYSTEM AREA SETUP .....	5-4
5-3-2	GLOBAL WINDOW SETUP .....	5-6
5-3-3	CHARACTER STRING DATA SETUP .....	5-7
5-4	SET UP I/O .....	5-10
5-4-1	SET UP SIO .....	5-10
5-4-2	SET UP I/O .....	5-11
5-4-3	COMMUNICATION SETUP .....	5-13
5-4-4	FUNCTION SETUP .....	5-14
5-5	PLC SETUP .....	5-16
5-5-1	SET UP OPERATION SURROUNDINGS (1:1) .....	5-16
5-5-2	SET UP OPERATION SURROUNDINGS (n:1) .....	5-17
5-5-3	STATION SETUP .....	5-18
5-5-4	CUSTOMIZE SETUP .....	5-21
5-6	INITIALIZE INTERNAL MEMORY .....	5-23
5-7	SET UP TIME .....	5-24
5-8	SET UP SCREEN .....	5-25
5-9	FONT SETTING .....	5-26

---

## Chapter 6 RUN and Errors

6-1	GP RUN Mode .....	6-1
6-1-1	After Powering Up .....	6-1
6-1-2	OFFLINE Mode .....	6-2
6-2	Troubleshooting .....	6-3
6-2-1	GP Problems .....	6-3
6-2-2	No Display .....	6-4
6-2-3	Can Not Communicate With Host (PLC) .....	6-7
6-2-4	When Touch Panel/Function Keys Do Not Work .....	6-9
6-3	SELF-DIAGNOSIS .....	6-10
6-3-1	SELF-DIAGNOSIS Features .....	6-10
6-3-2	SELF-DIAGNOSIS - Detailed Explanation .....	6-11
6-4	Error Messages .....	6-13
6-4-1	Error Message List .....	6-13
6-4-2	Error Message - Details .....	6-14

## Chapter 7 Maintenance

7-1	Regular Cleaning .....	7-1
7-2	Periodic Check-up .....	7-2

## Index

---

## Package Contents

---

The GP-H70's packing box contains the items listed below. Please confirm that everything illustrated here has been included.

■ **GP-H70 Unit**

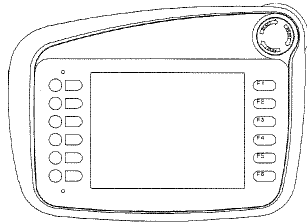

■ **Strap (1 pc.)**



■ **GP-H70 User's Manual**  
(sold separately)

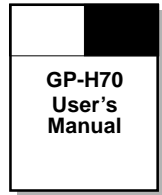

■ **Operation Instructions**  
(Included)

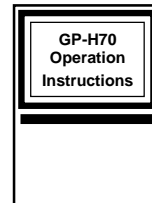

This unit has been carefully packed, however, should you find any item to be either damaged or missing, please contact your local GP-H70 distributor immediately for service.

---

## Information Symbols

---

The list below describes the symbols and abbreviations used in this manual.



Indicates a potentially hazardous situation which could result in serious injury or even death, if the instructions are not followed.



Indicates a potentially hazardous situation which could result in minor injury or equipment damage if the instructions are not followed.



Explains a situation that requires a moderate amount of user caution.

GP-H70  
Screen Editor

Refers to the “GP-PRO/PBIII for Windows®95” software.

PLC

Abbreviation for “Programmable Logic Controller”

\*1

Indicates supplemental explanatory information is located nearby, usually at the bottom of the page.



Indicates additional, relevant information.



Reference pages of related sections and topics.

The Tag Reference, Operation, Software Operation, PLC Connection, and Parts List Manuals referred to here are those included in the GP-PRO/PBIII for Windows®95 software package.

n:1

n:1 (multi-link) connection setup.

---

# *Memo*

# Chapter 1

## 1-1 Prior to Operating the GP-H70

### 1-2 System Design

### 1-3 Optional Equipment

# Introduction

## 1-1 Prior to Operating the GP-H70

Prior to operating the GP, be sure to perform the following steps.

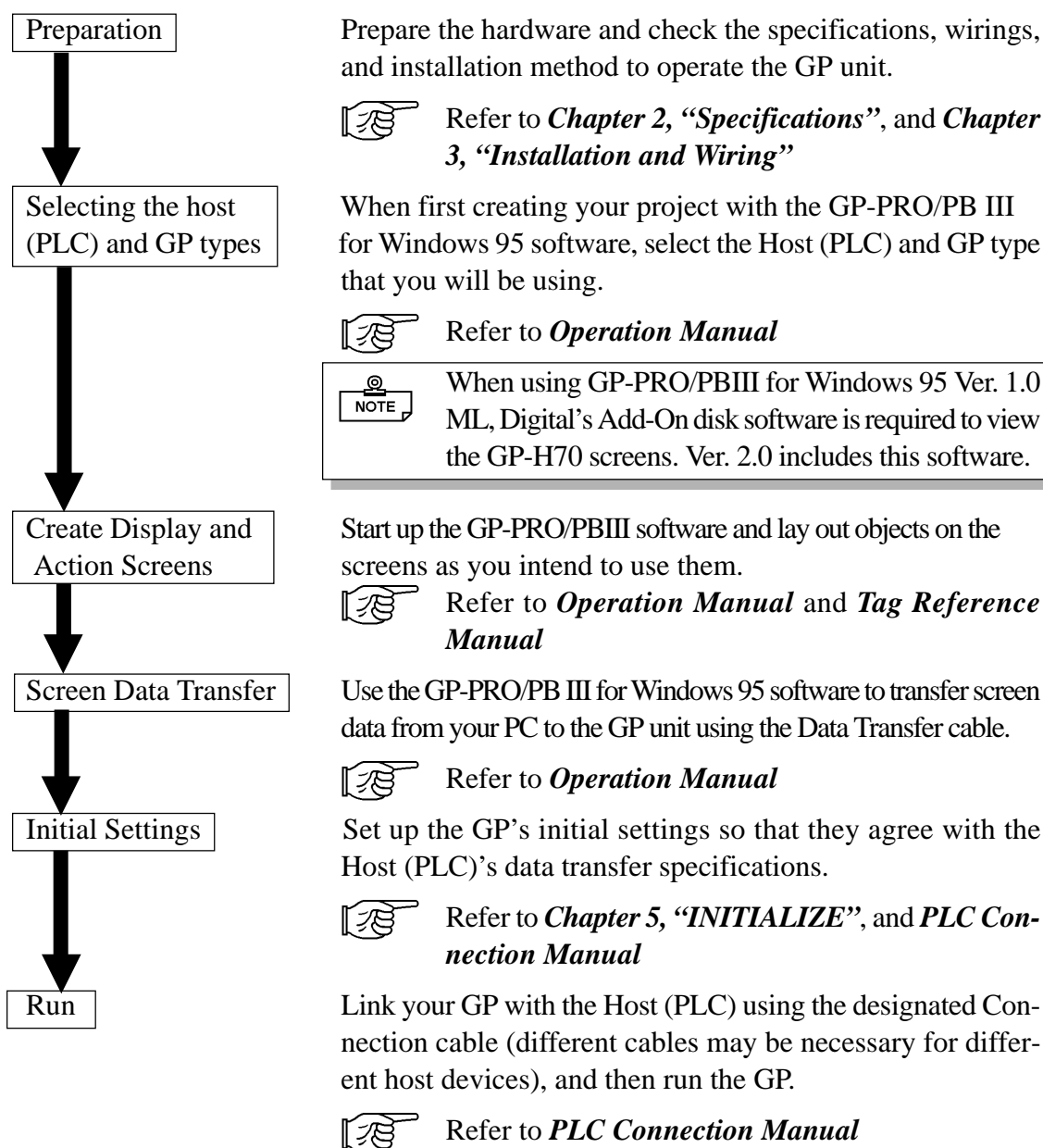

# 1-2 System Design

The diagram below shows the GP unit's peripheral equipment.

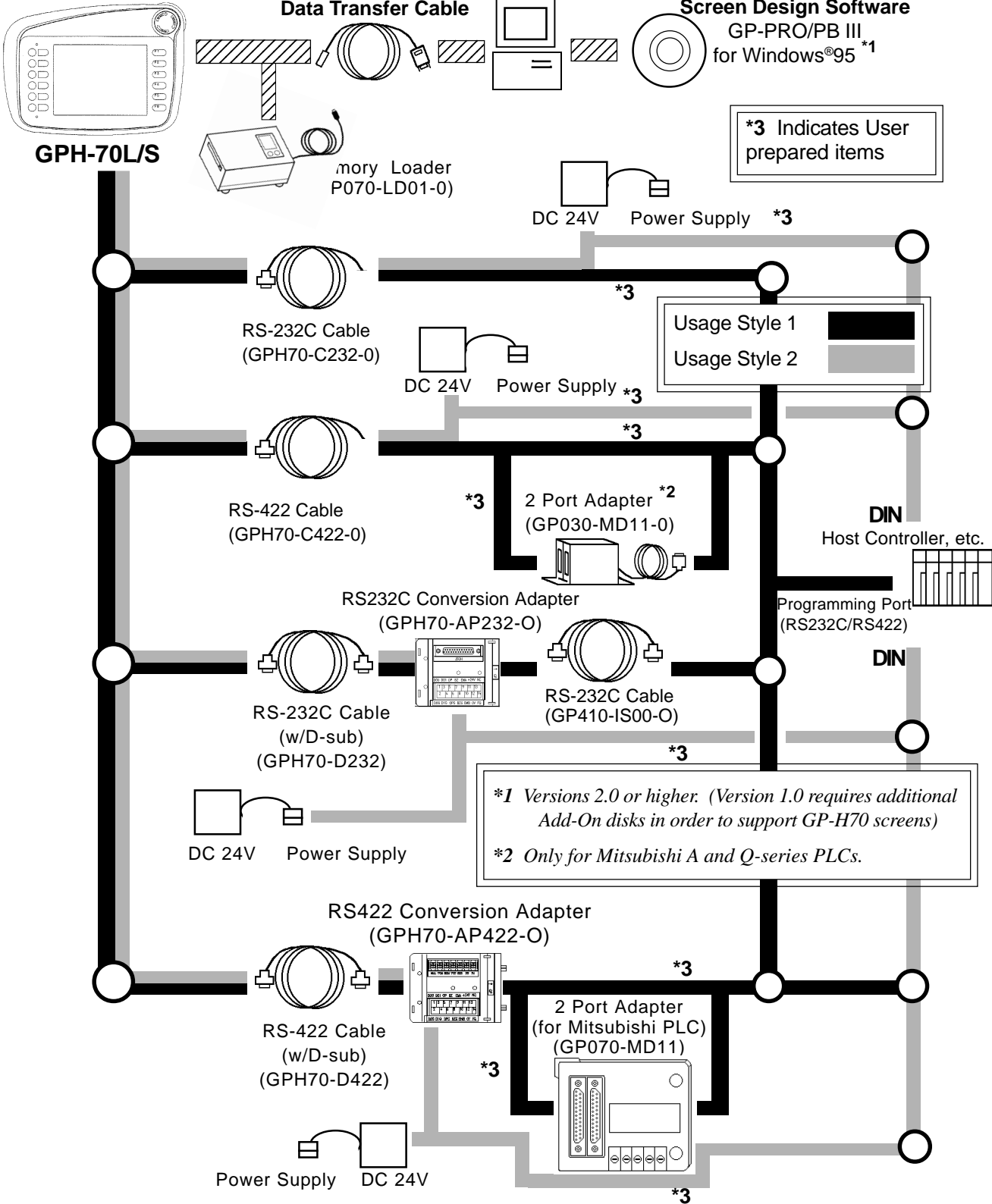

# 1-3 Optional Equipment

All optional items listed below are Digital Electronics Corporation products.

	ITEM	DESCRIPTION
<b>Screen Creation/Editing Software</b>	<b>GP-PRO/PB III for Windows 95</b> (GPW-PB01ML-V*<CD-ROM>) (GPW-PB02ML-V*<Floppy disk>)	<b>GP-PRO/PB III for Windows 95</b> PC based screen design software for GP display screens.
<b>Tool</b>	<b>Data Transfer Cable</b> (GPW-CB-SET)	Connects your PC to the GP, allowing screen data to be transferred between the two.
	<b>Memory Loader</b> (GP070-LD01-O)	Copies data at high speed from one GP to another. (Both system and screen data)
<b>Optional Parts</b>	<b>Cover Sheet</b> (GPH70-DF10-O)	Disposable sheets provide protection from a variety of elements. The GP's touch panel can be used with this cover sheet attached.
	<b>GP-H70 Optional Cable</b> [RS-232C type] (3 meters) (GPH70-C232-O)	Included in this cable are the power line to the GP-H70; the communications lines (RS-232C) used with various Host (PLC)s; the GP-H70's DOUT signal line, as well as other lines. This cable has no PLC connector attached so the user can set up the cable's PLC side wires to suit any type of PLC connector.
	<b>GP-H70 Optional Cable</b> [RS-422 type] (3 meters) (GPH70-C422-O)	Included in this cable are the power line to the GP-H70; the communications lines (RS-422) used with various Host (PLC)s; the GP-H70's DOUT signal line, as well as other lines. This cable has no PLC connector attached so the user can set up the cable's PLC side wires to suit any type of PLC connector.
	<b>GP-H70 Option Cable</b> [RS232C, with D-sub connector] (GPH70-D232) (3 meters)	Included in this cable are the power line to the GP-H70; the communications lines (RS-232C) used with various Host (PLC)s; the GP-H70's DOUT signal line, as well as other lines. This cable's PLC side connector is a standard DSUB25 pin type.
	<b>GP-H70 Option Cable</b> [RS422, with D-sub connector] (GPH70-D232) (3 meters)	Included in this cable are the power line to the GP-H70; the communications lines (RS-422) used with various Host (PLC)s; the GP-H70's DOUT signal line, as well as other lines. This cable's PLC side connector is a standard DSUB25 pin type.
	<b>GP-H70 Conversion Adapter</b> [RS232-C] (GPH70-AP232-O)	This adapter is used to convert the wiring from the GP-H70 to either a D-sub25 or standard a terminal block connector. Digital's RS232C cable (GP410-IS00-O) can be connected to the D-sub25 connector, and Digital's GPH70-D232 cable can be used to connect the adapter to the GP-H70 unit.
	<b>GP-H70 Conversion Adapter</b> [RS-422] (GPH70-AP422-O)	This adapter is used to convert the wiring from the GP-H70 to either a D-sub25 or standard a terminal block connector. Digital's GPH70-D422 cable can be used to connect the adapter to the GP-H70 unit.
<b>Maintenance Parts</b>	<b>GP-H70 Hand Strap</b> (H70-HS00-MS)	Replacement hand strap for the GP-H70.
	<b>GP-H70 Cable Guard</b> (H70-CG-MS):	This guard is used to protect the cables connected to the GP-H70. Each optional GP-H70 cable includes one.



# *Memo*

This page intentionally left blank.

# 2

2-1 General Specifications

2-2 Functional Specifications

2-3 Interface Specifications

2-4 Names and Functions of  
GP Parts

2-5 GP Dimensions

## Specifications

This chapter provides the specifications for the GP-H70's general features, performance, and interface equipment. It also describes the names and dimensions of this unit's parts.

### 2-1 General Specifications

#### 1 Electrical Specifications

	GP-H70L / GP-H70S
<b>Operating Voltage</b>	20.4 to 27.6 VDC
<b>Power Consumption</b>	Under 12W (TYP 10W)
<b>Voltage Endurance</b>	1000VAC 10 mA 1 minute (between the live wire and grounding terminals)
<b>Isolation Resistance</b>	Above 20M $\Omega$ at 500VDC (between the live wire and grounding terminals)

#### 2 Environmental Specifications

	GP-H70L / GP-H70S
<b>Operating Temperature</b>	0 to 40° Celsius
<b>Storage Temperature</b>	-20 to 60 degrees Celsius
<b>Ambient Humidity</b>	20 to 85%RH (no condensation)
<b>Vibration Endurance</b>	10 to 25 Hz (X,Y,Z directions 30 minutes 2G)
<b>Noise Endurance</b>	Noise Voltage: 1000 Vp-p
	Pulse length: 1 microsecond
	Arise time (rise/fall): 1 nanosecond
<b>Atmosphere</b>	Free of corrosive gas
<b>Protective Structure</b>	Equivalent to IP63

Conditions: Using GP-H70 optional cables



If the cable and its water resistant packing are not securely fit together, there is a danger that water may leak into the GP-H70's case.

### 3 Other Items

Weight	Under 870g (GP unit only)
Cooling Method	Natural air circulation

## 2-2 Functional Specifications

### 1 Display Features

	GP-H70L	GP-H70S
<b>Display Type</b>	Monochrome LCD	STN Color LCD
<b>Display Colors</b>	White, Black	8 colors (white, red, blue, green, yellow, magenta, cyan, black) Frame thinning used to produce half-tones.
<b>Backlight</b>	CFL (at normal temperatures and humidity [25°C +/-3°C], lifespan of 25,000 hours)	
<b>Resolution</b>	320 x 240 pixels	
<b>Display Area</b>	115W x 86H (mm)	
<b>Attributes</b>	Blink/Reverse Video	
<b>Brightness Control</b>	Not available	
<b>Contrast Adjustment</b>	8 levels available	
<b>Characters</b>	Korean: (KSC5601-1992 codes) Hangul fonts (including Kanji)	
	Chinese: (GB2321-80 codes) simplified Chinese fonts	
	Taiwanese (Big 5 codes) traditional Chinese fonts	
	ASCII: (Code Page850) Alphanumeric (including European fonts)	
	Japanese: ANK 158 type, Kanji:6349 (includes non-kanji:453, and Standard JIS Type 1 and 2)	
<b>Char. Disp. #</b>	8 x 8 dot font: 40 Char. per row, 30 rows 8 x 16 dot font: 40 Char. per row, 15 rows 16 x 16 dot font: 20 Char. per row, 15 rows 32 x 32 dot or larger font: Japanese JIS Class 1 level	
<b>Character Size</b>	1, 2, 4, or 8-times size (both height and width) (Double size and larger characters can be displayed in high-quality fonts)	

### 2 Screen Memory

	GP-H70L / GP-H70S
<b>Internal Memory</b>	FLASH EPROM 1 Mbytes (holds up to 320 screens, assuming a standard screen size of 3.2 Kbytes)

### 3 Touch-Panel/Switches

	GP-H70L / GP-H70S
<b>Touch-Panel</b>	12 x 16 "squares" per screen; either single or double-touch activation can be selected.
<b>Function Keys</b>	12
<b>Operation Switches</b>	One is located on the back of the case; the other is the front face's function switch (OP.) key
<b>Push Button switch</b>	Push-Lock (E-Stop) type switch

### 4 External Interface

	GP-H70L / GP-H70S
<b>Serial Interface</b>	Asynchronous Transmission Method: RS-232C/RS-422 Data Length: 7 or 8 bits Stop Bit: 1 or 2 bits Parity: None, Odd or Even Data Transmission Rate: 2400 to 38400 bps
<b>Tool Connector</b>	Asynchronous Transmission TTL level non-procedural command interface (During Development) use this I/F to download screen data files (During RUN mode) use this I/F for the BarCode Reader
<b>External Output</b>	<b>DOUT</b> Two-Point Open Collector: 5 to 24V DC, 50 mA max.
	<b>OP.</b> One-Point Open Collector: 5 to 24V DC, 50 mA max.
	<b>Buzzer</b> One-Point Open Collector: 5 to 24V DC, 0.1 to 0.3 A
	<b>Push-Lock switch</b> Single B-contact, rated 30V DC, 0.3 A



Since the external signal line runs through the same cable as the GP's power supply, these signals may be affected by power supply noise. Be sure to take appropriate measures where any (external) devices are connected (i.e. connect a noise filter, etc.).

## 2-3 Interface Specifications

This section describes the specifications of interface which can be connected to the GP-H70.

### 1 Serial Interface

The RS-232C or RS-422 (serial) ports are used for connecting to the Host (PLC).

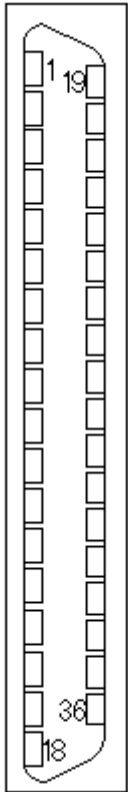
Pin Connection	Pin #	Signal Name	Condition
	Case	FG	Frame ground
	1	RS	Request To Send (RS-232C)
	2	CS	Clear To Send (RS-232C)
	3	CD	Carrier Detect (RS-232C)
	4	VCC	5V output, Max. 0.1 A
	5	TRMX	Termination (RS-422)
	6	RDA	Receive Data A (RS-422C)
	7	SDA	Transmit Data A (RS-422)
	8	CSA	Clear To Send A (RS-232C)
	9	ERA	Enable To Receive A (RS-422)
	10	DOUT1C	DOUT1 Output
	11	DOUT0C	DOUT0 Output
	12	OP.C	OP Output
	13	BUZZ OUT	External Buzzer Output
	14	EMG A	Push-Lock Switch A
	15	NC	Not Connected
	16	+24V	Power input +24 V (all three pins should be connected)
	17	+24V	
	18	+24V	
	19	SD	Transmit Data (RS-232C)
	20	RD	Receive Data (RS-232C)
	21	ER	Enable To Receive (RS-232C)
	22	SG	Signal Ground
	23	NC	Not Connected
	24	RDB	Receive Data B (RS-422)
	25	SDB	Transmit Data B (RS-422)
	26	CSB	Clear To Send B (RS-422)
	27	ERB	Enable To Receive B (RS-422)
	28	DOUT1GND	DOUT1 Ground
	29	DOUT0GND	DOUT0 Ground
	30	OP.GND	OP Ground
	31	BUZZ GND	External Buzzer Ground
	32	EMG B	Push-Lock Switch B
	33	NC	Not Connected
	34	0V	Power Input 0 V (all three pins should be connected)
	35	0V	
36	0V		

- Recommended connector: PCR-E36FS  
[by Honda Communications Industry Co., Ltd.]
- Recommended guard: PCS-E36LA  
[by Honda Communications Industry Co., Ltd.]
- Recommended cable: NHSCKF [by Kaneko Cord Co., Ltd.]



When connecting to a manufacturer's PLC, be sure to refer to *PLC Connection Manual*.

### ■ Connection Methods

Every optional cable will require some preparation before it can be used. Digital's PLC Connection Manual includes the connection diagram(s) of the wiring connections used between the GP and PLC, however, the pin assignments used from the connector to the GP-H70's interface will differ from those used for the GP. Therefore, be sure to use the following connector pin comparison tables 1 (RS-232C) and 2 (RS-422) when connecting a cable between the GP-H70 and the PLC.

**Comparison Table 1**

(RS-232C)

GP-H70	Signal Name	GP
1	RS	4
2	CS	5
3	CD	8
19	SD	2
20	RD	3
21	ER	20
22	SG	7

**Comparison Table 2**

(RS-422)

GP-H70	Signal Name	GP
5	TRMX	9
6	RDA	10
7	SDA	11
8	CSA	21
9	ERA	22
24	RDB	16
25	SDB	15
26	CSB	18
27	ERB	19
22	SG	7



**When connecting the PLC, refer to the PLC Connection Manual (which comes with the GP-PRO/PBIII FOR WINDOWS 95 software).**

## Specifications



- When connecting the Host (PLC) side of an optional cable, be aware of the following points:

<For RS-422 connections>

- Be sure to short pins 26 (CSB) and 27 (ERB), as well as 8 (CSA) and 9 (ERA).
- Connecting No. 5 (TRMX) to No. 6 (RDA) provides a terminating resistance of 100Ω between RDA and RDB.
- When creating an RS-422 cable and “Memory Link” connection has been selected, be sure to choose the four (4) wire type of cable.

### ■ 2-Port Adapter Connection Diagram (with Digital’s GPH70-C422-O cable)

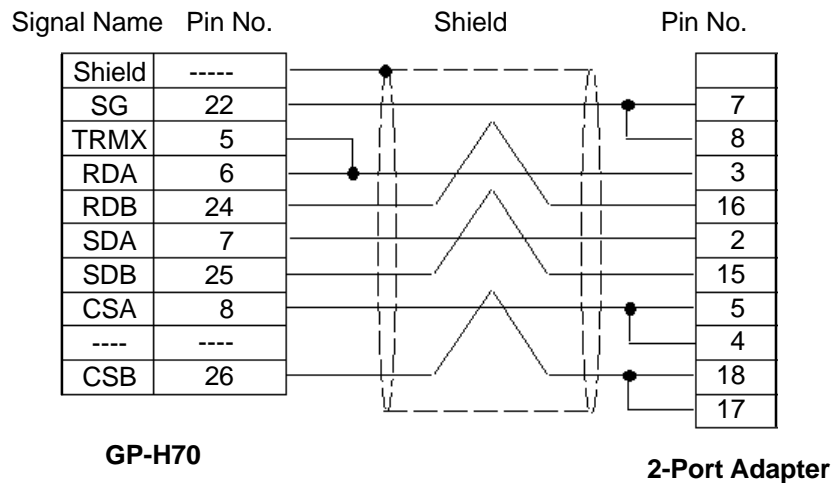

#### [GP-H70 series]

- Pin numbers are for the GP-H70 unit’s connector.
- Line colors are the optional cable’s colors (GPH70-C422-O).

#### [2-Port Adapter]

- Pin numbers are those for the 2-port adapter’s connector (GP030-MD11-O), made by the Digital Electronics Corporation.



◆ Connection Drawing for Mitsubishi PLC 2 Port Adapter (GP070-MD11)

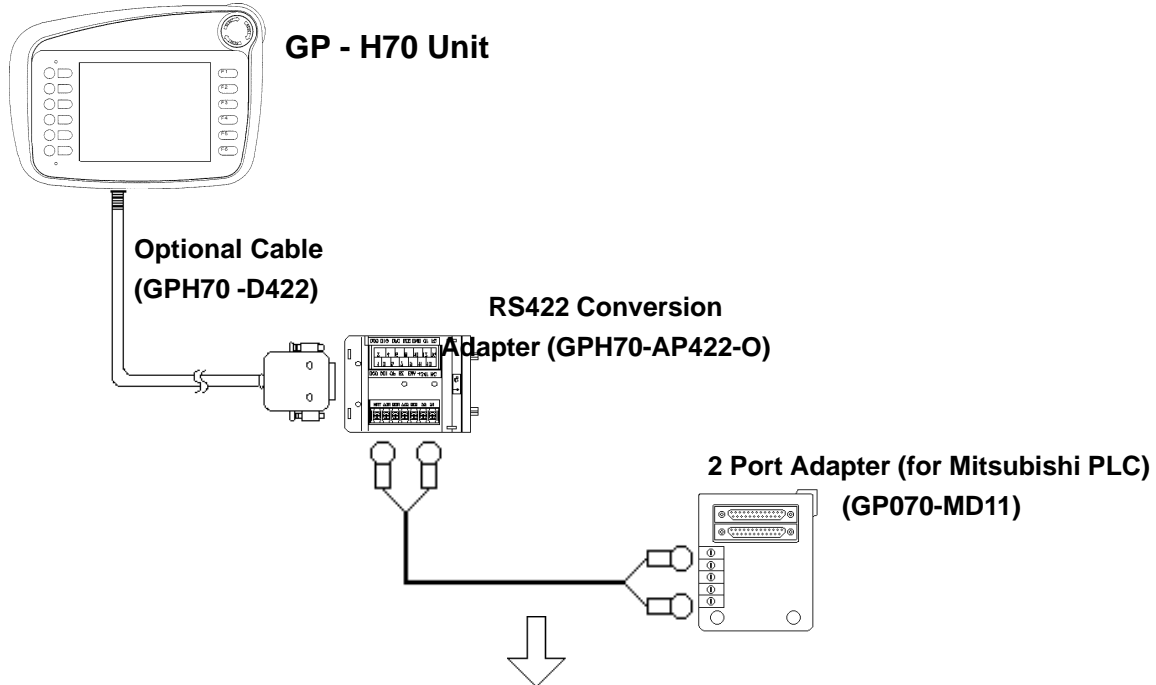

Signal Names for RS422 Conversion Adapter's Terminal Block

Pin No.	Signal No.	Shield
1	FG	
2	SG	
3	SDB	
4	SDA	
5	RDB	
6	RDA	
7	TRMX	

2-Port Adapter Signal Names (for Mitsubishi PLC)

Pin No.	Signal No.
5	SG
4	RDB
3	RDA
2	SDB
1	SDA

NOTE

When using this Conversion Adapter for the Mitsubishi PLC, without using the TRMX terminal, 330 Ω of resistance is automatically created between the RDB and RDA terminals.

# Specifications

## External Buzzer Output

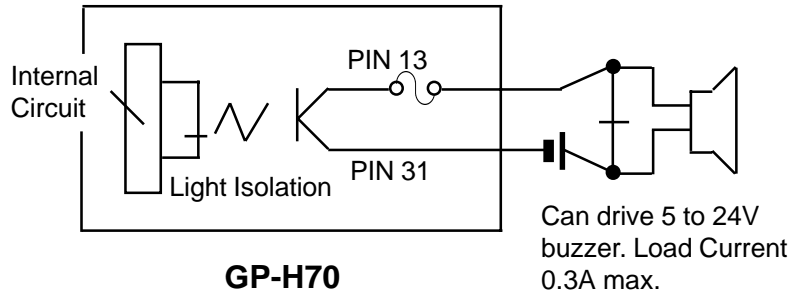

## Operation Switch and DOUT Switch Output Specifications

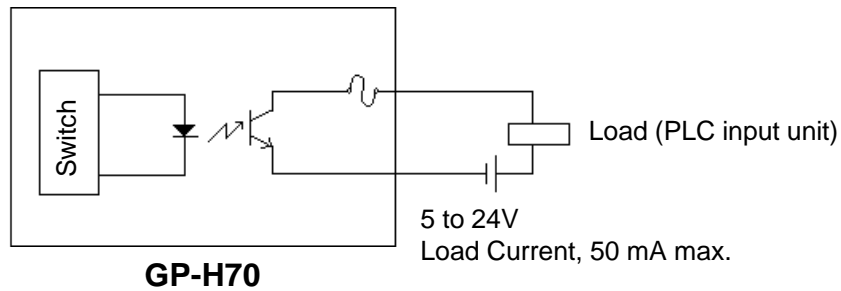

If the current level becomes higher than the rated value, the internal fuse will blow (melt). When connecting a load, be careful that the current flow is not excessive.

## Push-Lock Switch Output

Do not connect a load that exceeds the rated value. Connecting such a load may cause the GP-H70 to malfunction.

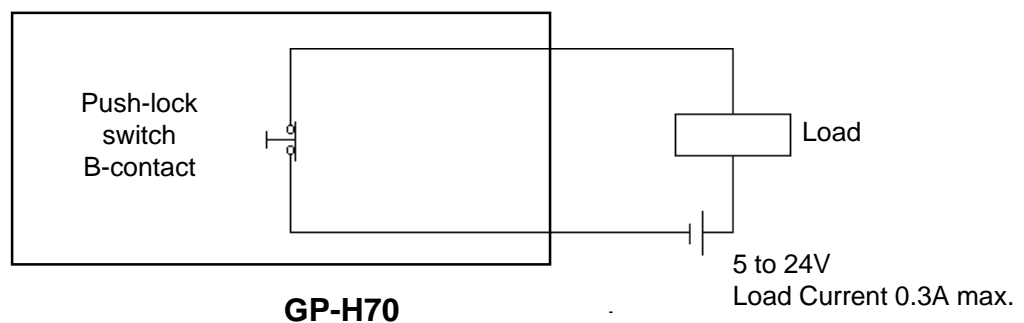

## 2-4 Names and Functions of GP Parts

This section shows the names of the various parts of the GP-H70 and describes their functions.

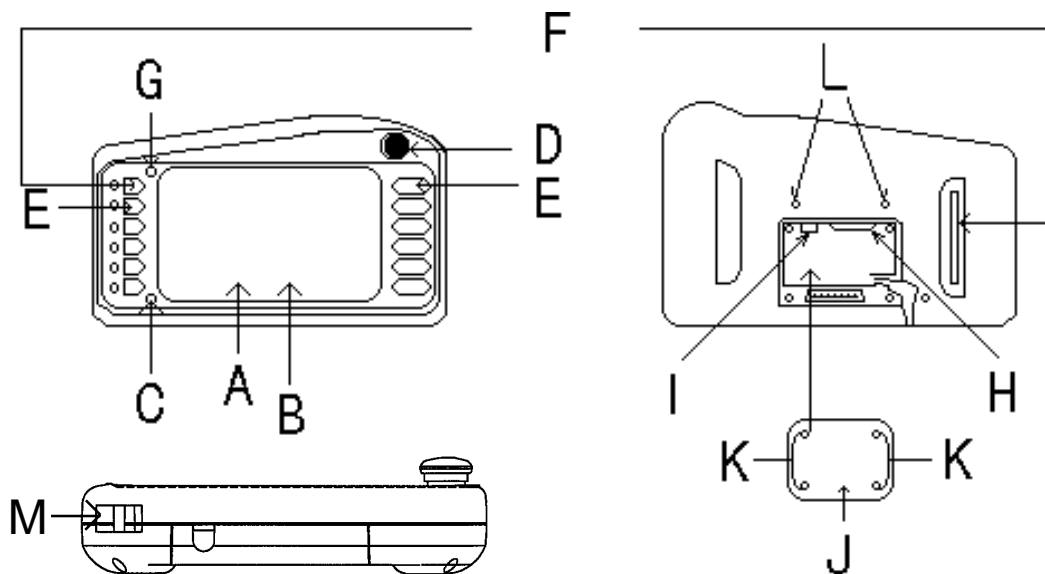

### A. Display

Shows both User-created screens and data from the Host (PLC).

GPH70-LG\*\*-24V: Monochrome LCD

GPH70-SC\*\*-24V: STN color LCD

### B. Touch Panel

Touching the panel face can change screens, activate screen items and write data to the Host (PLC).

### C. Power Lamp

Lights when the power is turned ON (green LED).

### D. Push-Lock switch

Uses a B-contact type signal. Since this contact's signal is output directly from the GP's I/F connector, this switch can be used as an emergency stop switch (pins 14 and 32).

## Specifications

---

### E. Function Keys

The GP-H70 has 12 function keys: the front face's OP. and F1 through F11 keys.

The OP. key is dual-purpose and can be used either as an operation switch or as a function key. Also, the F1 and F2 switches provide DOUT (Direct Output), in addition to the same T-tag, t-tag, and k-tag functionality provided by the other function keys.

These tag functions can all be easily assigned via the GP-PRO/PBIII for WINDOWS® 95 screen creation software.

### F. Operation Switches

The GP-H70 is equipped with two operation switches, one located on the front face of the unit, the other in the rear. The XOR logic of both switches is output from the GP-H70's I/F connector (pins 12 and 30).

### G. Operation Lamp (Green LED)

This lamp lights when either the front or rear operation switch is pressed.

### H. GP-H70 I/F Connector

This connector is used when performing wiring on the GP-H70, for either the 24 VDC power supply, the RS-232C or RS-422 connectors, the operation switches, the DOUT output, or the Push-Lock switch.

### I. Tool Connector

This connector is for the data transfer cable.

### J. Rear Connector Cover

This cover(s) protects the rear face connector(s) from moisture.

### K. Rear Connector Cover Screws

These screws attach the connector cover to the GP-H70 connector.

### L. Wall Mount Bracket Attachment Screws

These screws are used to connect the GP-H70's wall mount bracket to the rear of the GP-H70 unit.

### M. Hand Strap Attachment Slot

This slot is used to attach the hand strap.



For further information concerning the setting of the function keys, refer to the *GP-PRO/PBIII for WINDOWS®95 Operation Manual or Tag Reference Manual*.

## 2-5 GP Dimensions

### 1 GP-H70 External Dimensions

Unit: mm

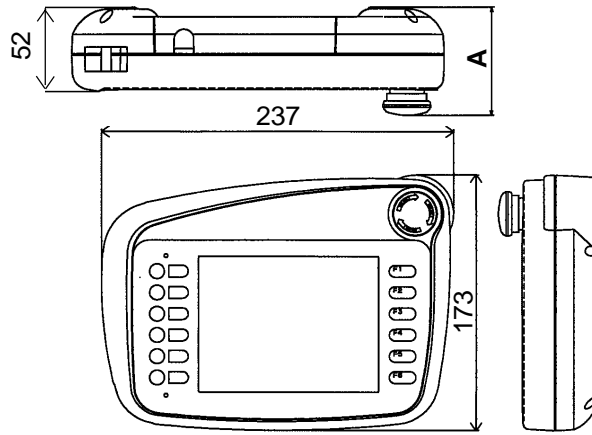

The above drawing's "A" dimension has been changed as follows:

Unit Revision	Standard Unit GPH70-LG11-24V GPH70-SC11-24V	Unit Revision	UL/CE Approved Unit GPH70-LG41-24VP GPH70-SC41-24VP
I or earlier	MAX68	G or earlier	MAX76
J or after	MAX71	H or after	MAX71

#### Checking the GP-H70 Revision Seal

Please check the GP-H70's rear face Revision Seal to determine its revision code. The code is indicated by the "\*" mark. In the following example, the revision code is "I".



Specifications

**2 GP-H70 Installation Bracket (Created by User)**

Unit: mm

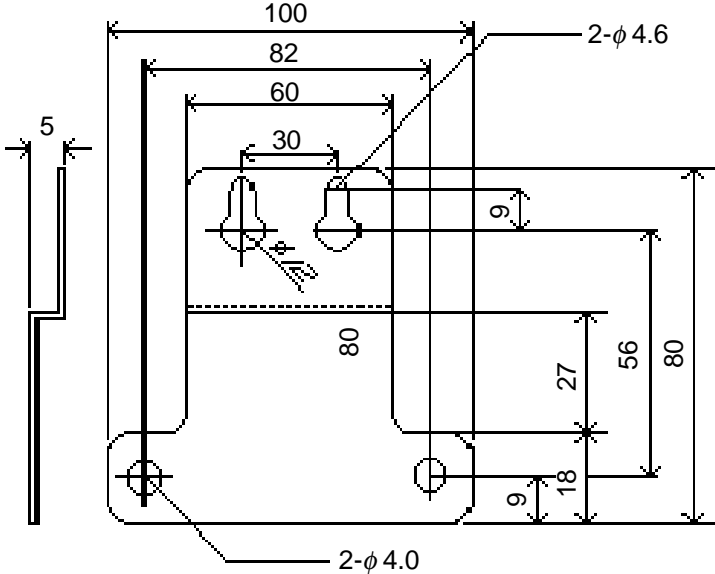

 The user should create the wall mount bracket according to the above illustration.

### 3 Hanging the GP-H70 on a Wall

To hang the GP-H70 on a wall, see the illustration below:

1. Secure the User prepared wall mount bracket to the rear of the GP-H70.

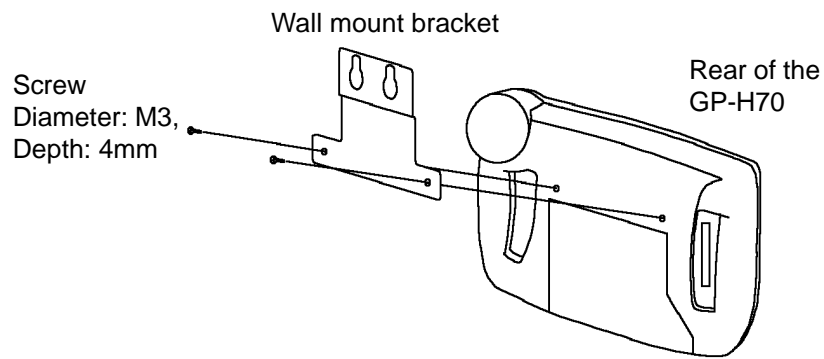

2. Screw the GP-H70 bracket's placement screws (shown) into the wall.

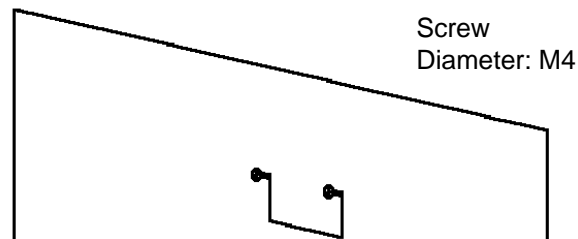

3. Hang the GP-H70 on the placement screws.

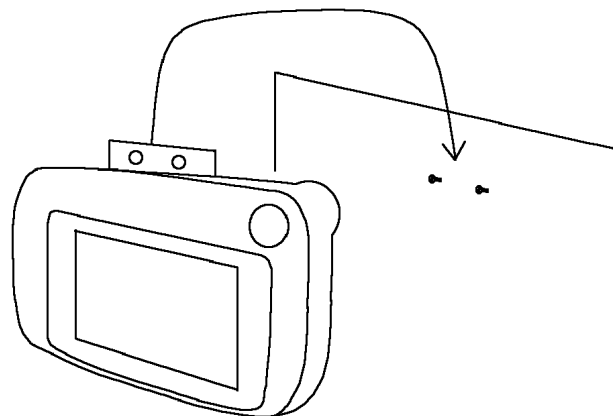

- Use only special purpose flange-type screws when hanging the GP on a wall.
- The screws used to attach the bracket to the GP unit should be as follows:  
diameter: M3, depth: 4 mm

# Installation and Wiring

## 3-1 Wiring

This section describes how to connect the GP-H70 power cable, and related precautions.

### 1 Connecting the GP-H70's Power Cable



#### WARNINGS

- **To avoid an electric shock, be sure the GP's power cable is unplugged from the power outlet before connecting the power cable's terminals to the GP.**
- The GP-H70 can only use 24V DC power. If you use other than 24V DC power, you will damage the GP's power supply and the GP unit.
- There is no ON/OFF power switch on the GP unit, so please be sure to connect a breaker type switch.



- When the FG terminal is connected, be sure the power cable is grounded. Not grounding the GP unit's power cable will result in excessive noise being created.
- If the GP-H70 will be used where it may be significantly affected by noise, it is recommended that a noise filter (PBW-1201-33, Nemic-Lambda Co.) be attached to the GP-H70's power line.

### 2 Precautions: Grounding

The I/F connector case of the GP-H70 should be grounded (FG). Be sure to use the cable's shielded line, and make sure it is grounded to a proper ground connection.

(Class 3 grounding, with a maximum resistance of 100Ω).



## 3-2 Tool Connector

Both the GP's Data Transfer Cable and Memory Loader Unit connectors (plugs) are connected to the GP's Tool Connector's socket. This tool connector is located on the back of GP-H70.

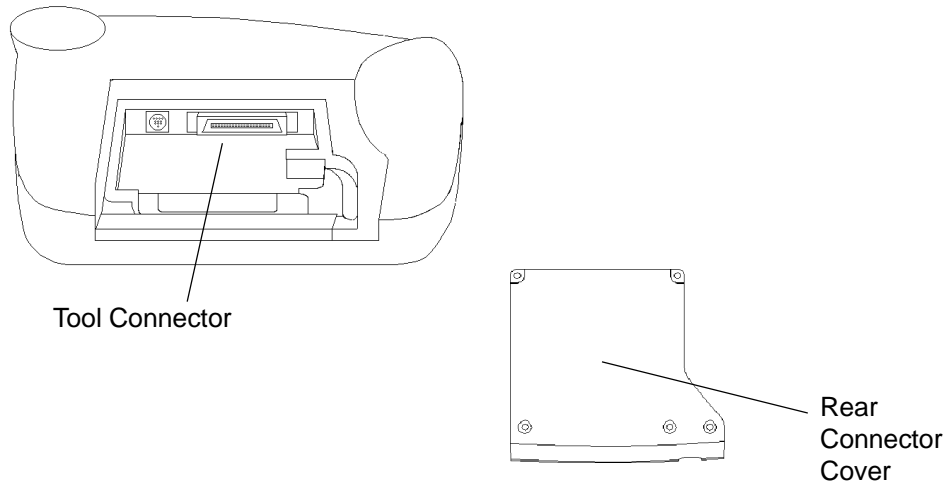

Remove the GP-H70's rear connector cover.



- Be sure to turn the GP OFF before inserting or removing a connector from the Tool Connector socket. (i.e. the power cord has been unplugged).
- Never attach or detach a connector while the GP unit is turned ON.

# 4

4-1 Using OFFLINE Mode

4-2 Main Menu Screen

4-4 SELF-DIAGNOSIS Functions

4-3 INITIALIZE Functions

4-5 Transferring Screen Data

## OFFLINE Mode

OFFLINE mode refers to the Initialize, Self-Diagnosis, and other setup information contained in the GP. You will need place the GP unit in OFFLINE mode before changing any of these settings or using any of these features.



The first time you use the GP-H70, system program data must be sent to the GP-H70 from the GP-PRO/PBIII for WINDOWS®95 program. Otherwise, you will not be able to enter the GP's OFFLINE mode (initial setting screens).

To transfer system program data to the GP-H70, be sure its power cord is plugged in. Once screen data is transferred from your PC's GP-PRO/PBIII for WINDOWS®95 software to the GP-H70, system program data will also be automatically be sent together with it.

### 4-1 Using OFFLINE Mode

To INITIALIZE the GP's setup data or to run any of the SELF DIAGNOSIS programs, the user must first enter OFFLINE mode. There are two ways to enter OFFLINE mode: first, after plugging the GP in, and second, from the Forced Reset screen.

#### 1 Entering OFFLINE Mode - After Start-Up

Touch the top left corner of the GP screen with your fingertip within 10 seconds of plugging in the power cord.

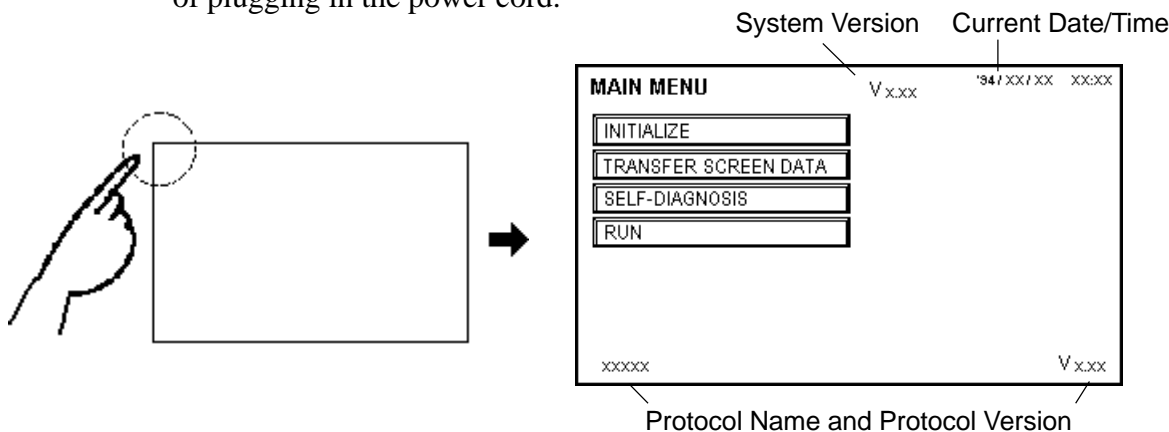

## 2 Entering OFFLINE Mode - From Forced Reset Screen

After calling up the Forced Reset screen, touch the OFFLINE button.



For more information about the Forced Reset Screen, refer to 5-4-2, “SET UP I/O”.

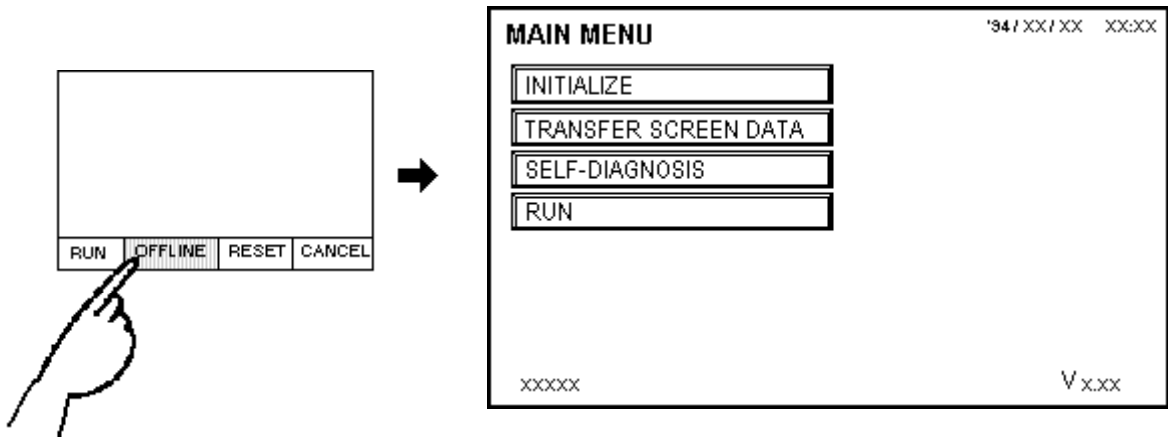

If the GP-H70 has the device monitor function, the following screen will appear.

Refer to Appendix 3 “Device Monitor”, in the *GP-PRO/PB III for Windows®95 PLC Connection Manual*.



Of all of Digital’s screen creation software, the GP-PRO/PB III for Windows®95 version is the only software that will allow you to utilize the device monitor function.

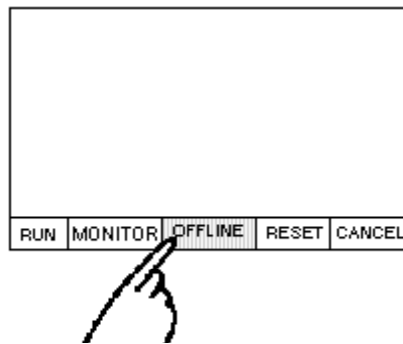

## OFFLINE Mode

---

If a Password has been designated in the Initialize/Set Up System screen, the following password input screen will appear prior to entering OFFLINE mode.

Enter the password, and then touch [SET] to enter OFFLINE mode.

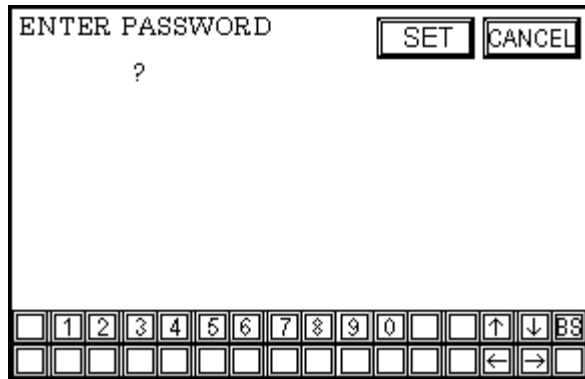

The screenshot shows a rectangular dialog box with a black border. At the top left, the text "ENTER PASSWORD" is displayed. In the center, a question mark "?" is shown. At the top right, there are two buttons labeled "SET" and "CANCEL". At the bottom, there is a numeric keypad with two rows of buttons. The first row contains buttons for digits 1 through 0, followed by an up arrow, a down arrow, and a backspace key labeled "BS". The second row contains buttons for left and right arrows, and a space key.



For more information on entering the Password, refer to 5-3-1, “*SYSTEM SET UP*”.



For more information on password input, refer to 4-3, “*INITIALIZE Functions/ Inputting Numbers*”.

## 4-2 Main Menu Screen

The Main Menu consists of the following four items: INITIALIZE, TRANSFER SCREEN DATA, SELF-DIAGNOSIS, and RUN. Each menu item in this screen has its own unique setup data that must be set so as to agree with the designated PLC in order for the GP to communicate properly.

- In OFFLINE mode, the following four areas are displayed. Select the desired menu item by touching that item's selection box.

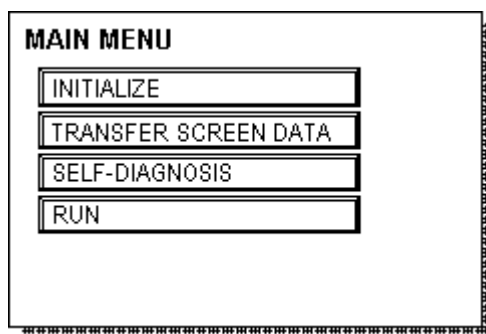

### INITIALIZE

This area's data is used for the operation of the GP unit.

### TRANSFER SCREEN DATA

This area's functions are used to either transfer screen data to, or receive data from the screen editing software in the user's PC.

### SELF-DIAGNOSIS

These functions are used to diagnose GP System and Interface (I/F) problems.

### RUN

Starts the GP unit (begins communication with the Host (PLC)).



For more information about:

- INITIALIZE area, refer to *Chapter 5, "INITIALIZE"*.
- TRANSFERRING SCREEN DATA area, refer to *Operation Manual*.
- SELF-DIAGNOSIS and RUN areas, refer to *Chapter 6, "RUN and Errors"*.

## 4-3 INITIALIZE Functions

This section describes the basic operations used to enter INITIALIZE setting data.

### ■ Selecting Menu Items

Touch INITIALIZE to call up the INITIALIZE area's sub-menu.

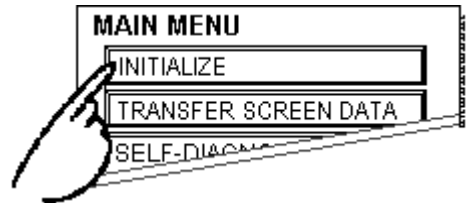

Use the arrow keys to select the menu item you want to use, or touch its entry field.

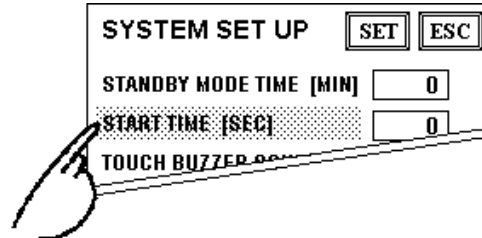

### ■ Inputting Numbers

When you select a menu item or touch its entry field, a keyboard will appear on the screen allowing you to enter a value. After entering that value, touch the [SET] key to register the value.

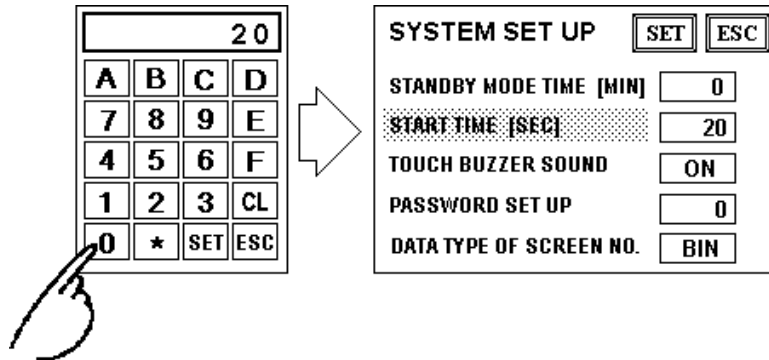

### ■ Selecting Setup Conditions

When a menu item is selected, its options will appear. Touching the entry field for that item will toggle the available options. Use this feature to choose a specific parameter.

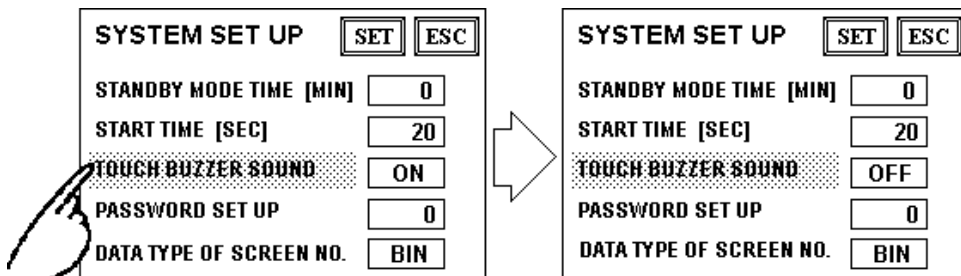

■ **Completing Data Entry**

To enter a screen's setting data, touch the top-right corner's "SET" button.

If, however, you wish to exit the screen without registering any data changes, touch the ESC button.

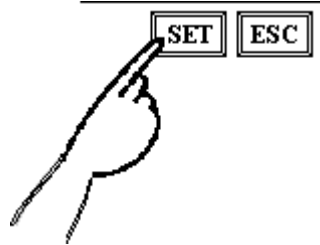

- Touching the SET key writes the current Setup data to the GP's internal FEPRAM. This operation may take some time to perform. Please do not touch the screen until the previous menu display reappears.
- Touching the ESC key cancels the writing of the SETUP data and returns to the previous menu.

■ **Moving (Returning) to Screens**

Touch the tab (title bar) of the screen you would like to move to.

E.g. To return to the MAIN MENU from the SYSTEM ENVIRONMENT SETUP screen, simply touch the MAIN MENU tab (title bar).

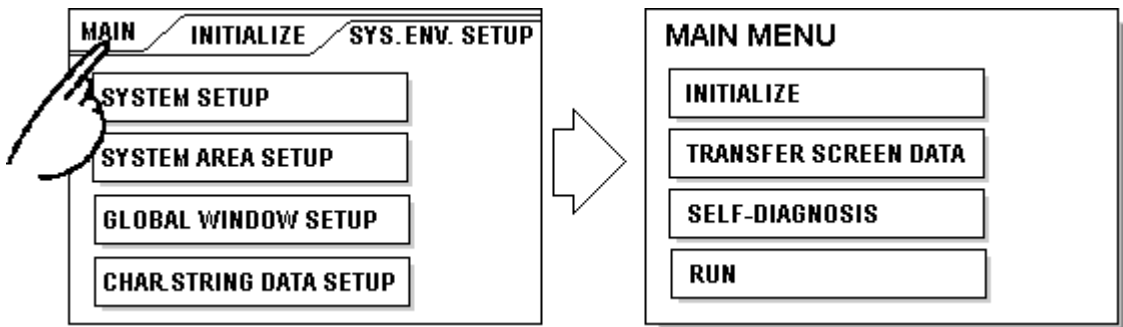

## 4-4 SELF-DIAGNOSIS Functions

This section describes how to utilize the GP's self-diagnosis function.

### ■ Selecting A Menu Item

Touch the desired menu item.

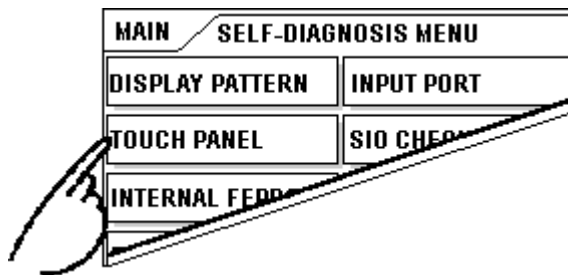

### ■ SET, ESC Keys

After selecting a SELF-DIAGNOSIS menu item, the SET and ESC keys will appear at different times at the top right corner of the screen.

E.g.

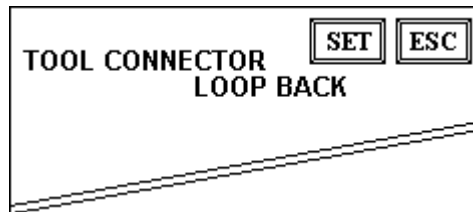

#### SET Key

Use this key to register the value(s) entered.

#### ESC Key

Touching this key cancels any changes made to Self-Diagnosis area settings and returns the user to the main Self-Diagnosis menu.



■ **Diagnosis Completed - Check OK**

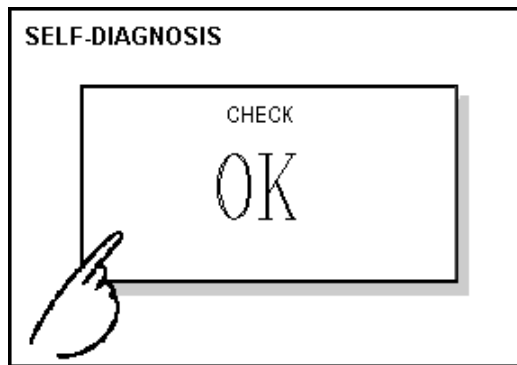

When the words “OK” appear, touching once anywhere on the screen returns you to the previous Self-Diagnosis area menu.

■ **Diagnosis Completed - Error**

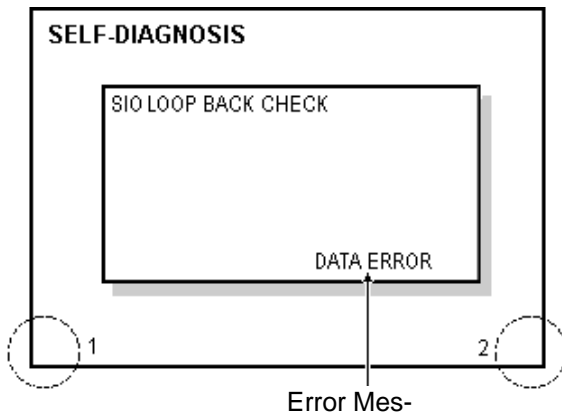

When an error message appears, touch the lower left (1) and right (2) corners at the same time to return to the normal self-diagnosis screen.

■ **Returning To The Main Menu**

Touch the MAIN tab in the SELF-DIAGNOSIS menu to return to the MAIN MENU screen.

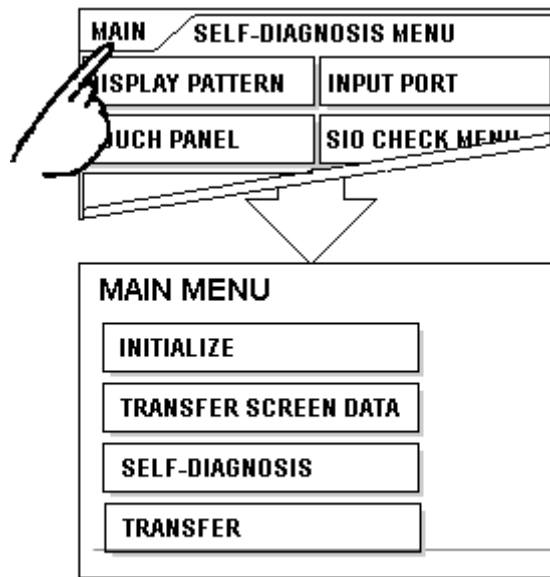

## 4-5 Transferring Screen Data

This section describes how to both transfer screen data to the GP, and receive data from the GP.

First, connect the GP's rear face tool connector to the data transfer cable's round connector  $\times$ . Then, connect the other end of the data transfer cable to your PC's RS-232C connector  $\square$ .

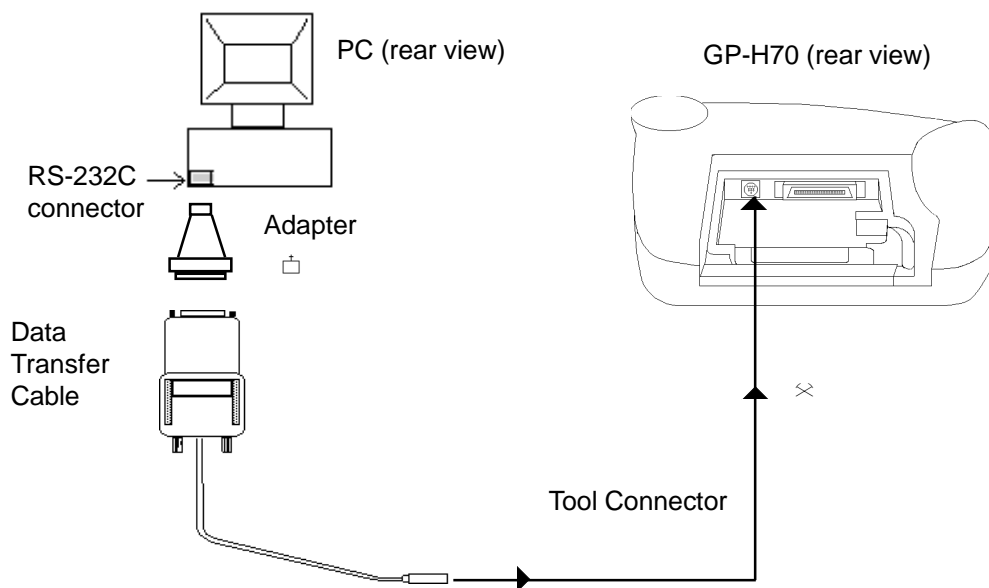

- Use the adapter included in the GP-PRO/PBIII for Windows 95 software package's "Cable Set" to connect the data transfer cable's connector with your PC's Serial Port connector.
- When using a serial mouse with your PC, be sure to use a different serial port for data transfer.

First, connect the GP's power cord and then select either the TRANSFER SCREEN DATA or RUN mode. If you are using your GP for the first time, you must first transfer system program data from the GP screen editing software to the GP in order for it to operate. After this system data is transferred, the OFFLINE mode screen (INITIALIZE) will appear.

When using the GP-PRO/PBIII for WINDOWS<sup>®</sup>95 program to transfer data to the GP-H70, be sure to designate whether the screen data will be sent to or received from the GP-H70.



Refer to *Operation Manual, Chapter 7 - "Transmitting and Receiving Data"*

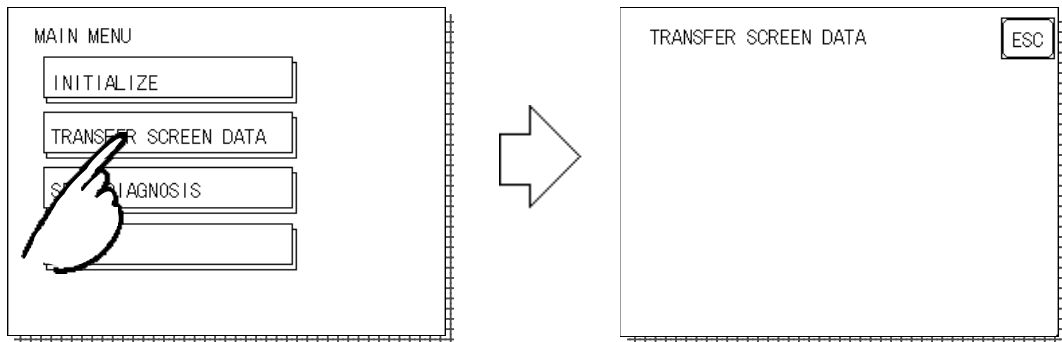

While data is being transferred, the messages “SETUP TRANSFER” and “Transferring Data, Please Wait” will appear. When this message disappears, data transfer is completed. To stop the transfer of data at any time, touch the [ESC] key. When data is being transferred, if “Setup” \*1 is being performed, the screen selected in the “Startup Settings/Startup Screen File Number” setting will appear. If “Setup” is not being performed, the GP’s main menu (shown above) will appear.

---

\*1 “Setting Up” the GP means transferring system data to the GP so that it can be used in a specific environment, i.e. with a specific PLC. This is performed during screen data transfer, when the required GP system program data and PLC protocol driver are automatically sent from the GP screen editing software to the GP unit.

# 5

## INITIALIZE

5-1 Prior To Entering Initial Data

5-2 INITIALIZE Menu Items

5-3 SYSTEM ENVIRONMENT  
SETUP

5-4 SET UP I/O

5-5 PLC SETUP

5-6 INITIALIZE INTERNAL  
MEMORY

5-7 SET UP TIME

5-8 SET UP SCREEN

5-9 FONT SETTING

### 5-1 Prior To Entering Initial Data

For the GP to run correctly, various GP Setup data (items) must first be verified. This data is called the INITIALIZE data.

This chapter explains each of the OFFLINE mode's INITIALIZE menu items. There are two types of INITIALIZE data used, one for the **1:1** (direct) connection and the other for the **n:1** (multi-link) connection \*1.

- 1:1** A single (1) GP is connected to a single (1) PLC. (Direct connection)
- n:1** Multiple GP's are connected to a single (1) PLC. The GPs successively pass a token (exclusive PLC interaction key) among themselves to designate which can communicate with the PLC.

The "**n:1**" mark appears on menu items concerned only with the **n:1** multi-link connection. If no mark is used, the menu item is common to both **1:1** and **n:1** connections.



If a GP-PRO/PB III Project's System File (S0)\*2 is transferred to a GP, the GP will operate according to that data's specifications. Thus, if the necessary system file data has been correctly designated and transferred to the GP, INITIALIZE area data entry becomes unnecessary.



For information concerning the data contained in the System File (S0), refer to *Operation Manual*.

\*1 PLCs that support the **n:1** (multi-link) connection are limited.



Refer to *PLC Connection Manual*

\*2 With the GP-PRO/PB III for Windows®95, this stands for the [GP System Settings] data.

## 5-2 INITIALIZE Menu Items

Here, the screens displayed in each of the Initialize Menu areas are shown.



For further information concerning OFFLINE mode screen operation and numeric input, refer to *Chapter 4, "OFFLINE Mode"*.

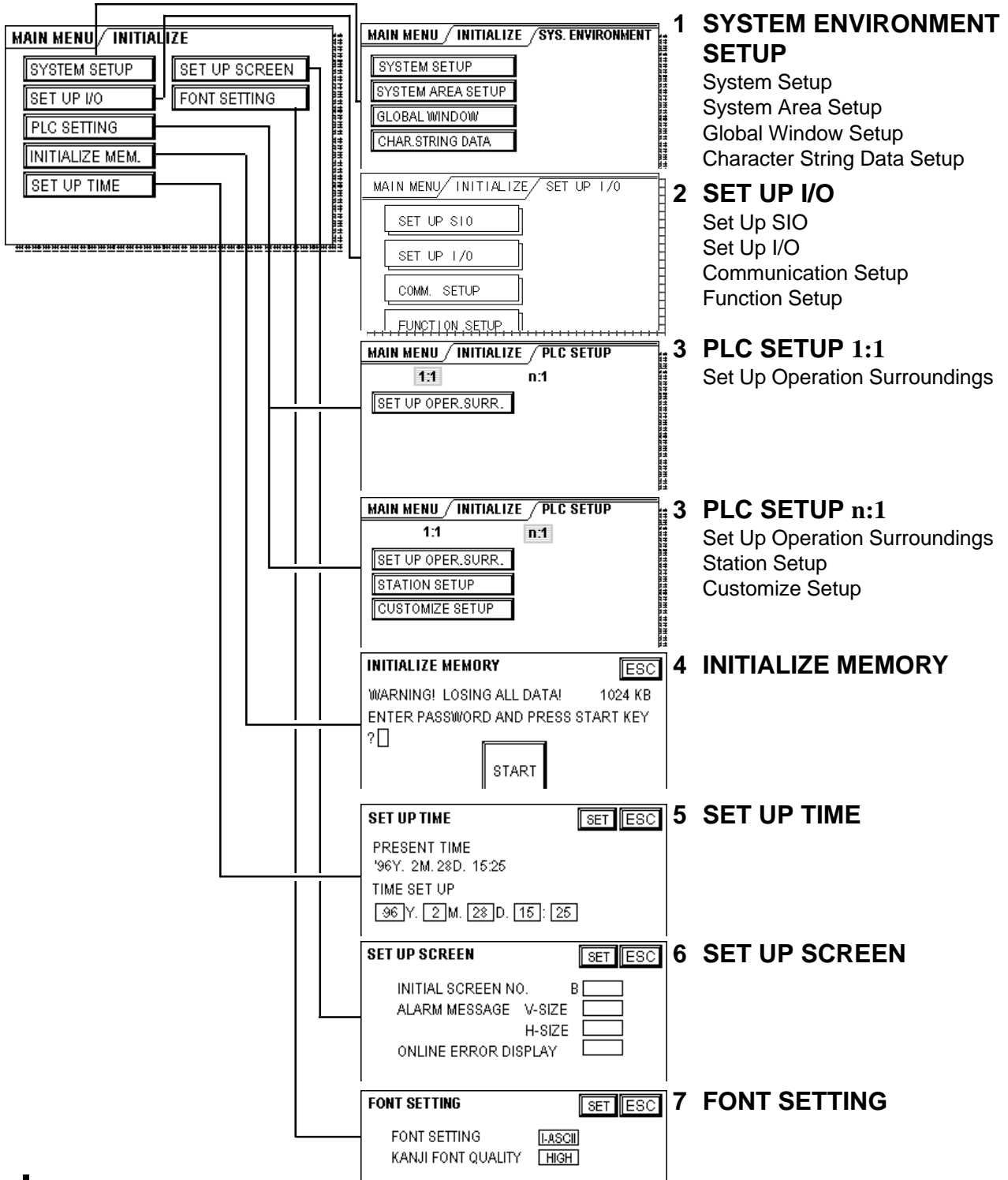

## 5-3 SYSTEM ENVIRONMENT SETUP

Here, the GP system settings can be changed. The SYSTEM ENVIRONMENT SETUP area includes the SYSTEM SET UP, SYSTEM AREA SET UP, GLOBAL WINDOW SETUP, and CHARACTER STRING DATA SETUP areas.

### 1 SYSTEM SET UP

The GP-H70's system setting areas contain the following information. Refer to this data when setting up your GP.

SYSTEM SET UP		SET	ESC
STANDBY MODE TIME [MIN]	<input type="text" value="0"/>		
START TIME [SEC]	<input type="text" value="20"/>		
TOUCH BUZZER SOUND	<input type="text" value="ON"/>		
PASSWORD SET UP	<input type="text" value="0"/>		
DATA TYPE OF SCREEN NO.	<input type="text" value="BIN"/>		

#### ■ STANDBY MODE TIME (0-255)

To protect the GP's display, the GP has a screen saver function that automatically erases the screen when no GP operations have occurred for a certain period of time. A 0 entered in this field causes the current display to remain as it is.

When the SYSTEM DATA AREA's  *PLC Connection Manual*) SCREEN DISPLAY ON/OFF \*1 data is 0000h, and the following operations are not performed for the number of minutes designated by this setting, the GP will clear the display.

- Change Screen
- Touch Screen
- Alarm Display

#### ■ START TIME (0-255)

This data determines the start-up time delay used by the GP. This parameter is usually used to control the power-up sequence, e.g., so that the GP starts up only after its power cable is connected and the Host (PLC) has started.

\*1 When using either the Direct Access or the Memory Link formats, the object address becomes +9 or +12, respectively.

### ■ TOUCH BUZZER SOUND

Designates whether or not the GP beeps when the screen is touched.

### ■ PASSWORD SET UP

The password entered here will be required when entering either the INITIALIZE or OFFLINE modes. Thus, this password (number) protects the GP's current settings, since OFFLINE mode cannot be inadvertently entered. Use any number desired from 0 to 9999. If you do not wish to use this feature, enter the default value "0".

### ■ DATA TYPE OF SCREEN NO.

This area controls whether BIN or BCD format numbers are used when making screen changes and selections by touching the screen.

## 2 SYSTEM AREA SETUP

SYSTEM AREA SETUP data is necessary for the PLC to control the GP, as well as to prepare the areas used by the PLC's internal Data Memory (DM)\*1 and Data Registers (D). Use this area's settings to prepare the desired SYSTEM DATA AREA items. If the memory link setting is used, the setup described below is not necessary.



Refer to *PLC Connection Manual*

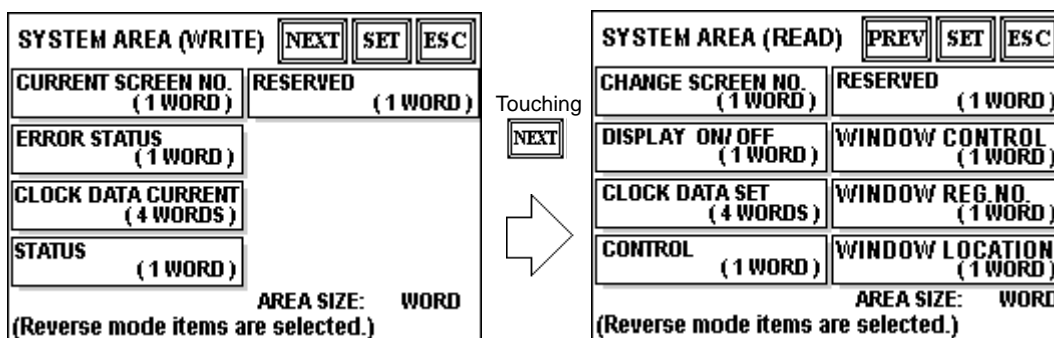

Touch the NEXT and PREV buttons to toggle between the SYSTEM AREA (WRITE) and SYSTEM AREA (READ) screens.

When an item is highlighted, it is selected. Touch it once to change to the other state or deselect it.

\*1 The data register (D) and data memory (DM) for the PLC are made by the Mitsubishi Electric Company Ltd. and the Omron Corporation, respectively.

## INITIALIZE

### ■ AREA SIZE display

This field displays the size, in “word” units, of the items selected in the SYSTEM AREA (both WRITE and READ items).

When you touch the SET key, the System Area Contents screen (see below) appears for you to verify the selected items.



- The settings shown are enabled only when using the Direct Access format.
- All selected System Area items displayed on the screen are System Data Area items.

Given that these five items, “Current Screen Number”, “Error Status”, “Clock Data (Current)”, “Change Screen Number”, and “Display ON/OFF”, have been selected, word addresses are then assigned to each item, in order, as shown below.

SYSTEM AREA CONTENTS		SET	ESC
WORD		WORD	
+0	CURRENT SCR.NO.	+10	
+1	ERROR STATUS	+11	
+2	CLOCK (CURRENT)	+12	
+3	CLOCK (CURRENT)	+13	
+4	CLOCK (CURRENT)	+14	
+5	CLOCK (CURRENT)	+15	
+6	CHANGE SCR.NO.	+16	
+7	DISPLAY ON/OFF	+17	
+8		+18	
+9		+19	



Addresses LS16 to LS19 are fixed (reserved) since they are used to control the Global Window. No other items/features can use these addresses.



For more information on LS areas 16 through 19, refer to the *PLC Connection Manual's section 1-1 “LS Area Structure”*.

The System Data Area allocation uses the formula [System Data Start Address + n]. For example, (referring to the System Area Contents screen displayed above) if the System Area Start Address was D00200, and the Change Screen Number option was selected, since the Change Screen Number's address has been set to +6, its word address would be  $D00200+6=D00206$ .



### 3 GLOBAL WINDOW SETUP

The GP-H70 can display one Global Window and up to two Local Windows at any one time. A Global Window will be common to all the display screens. The

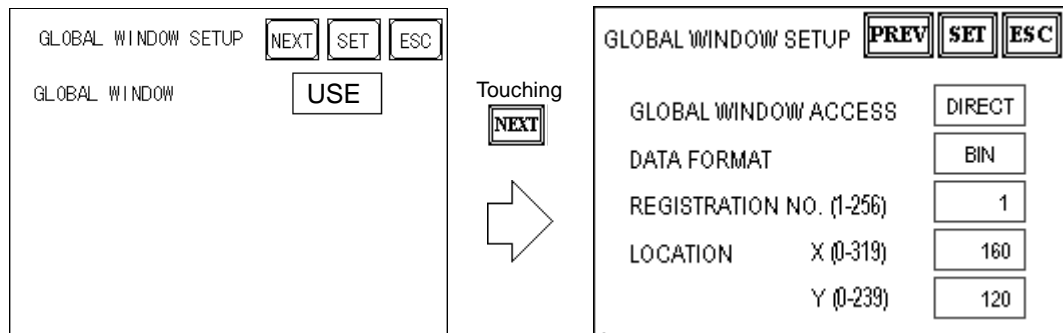

Local Window(s) will display only on the current base screen. Here, the setting up of the GLOBAL WINDOW is described.

#### GLOBAL WINDOW

When the first Global Window Setup screen appears, select whether to Use, or Not Use a Global Window. If you select Not Use, please ignore the items described below.

##### ■ GLOBAL WINDOW ACCESS

This setting designates whether the Global REGISTRATION NO. and the Window LOCATION are Direct or Indirect values. When designated as Direct, the REGISTRATION NO. and Window LOCATION values used are fixed to the values entered here.

When Indirect is designated, the WINDOW REG. NO. word address prepared in the System Area becomes variable - which means it can have a new REGISTRATION NO. written to it, and as a result, multiple WINDOW REG. NO.s can be used as the Global window. You can also change the Global window data's display position via this method.

##### ■ DATA FORMAT

Designates whether the REGISTRATION NO. and the Window LOCATION values are input as BIN or BCD numbers. Only Indirect values can be used in these fields.

##### ■ REGISTRATION NO. (1-256)

Designates the Window Screen Number used by the Global Window. This field is applicable only when the GLOBAL WINDOW ACCESS is set to Direct.

## ■ LOCATION

Designates the Global Window LOCATION. This field is applicable only when the GLOBAL WINDOW ACCESS is set to Direct.

## 4 CHARACTER STRING DATA SETUP

Character String Data order will vary from manufacturer to manufacturer. Designate the Character String Data order here that matches your PLC's data order.

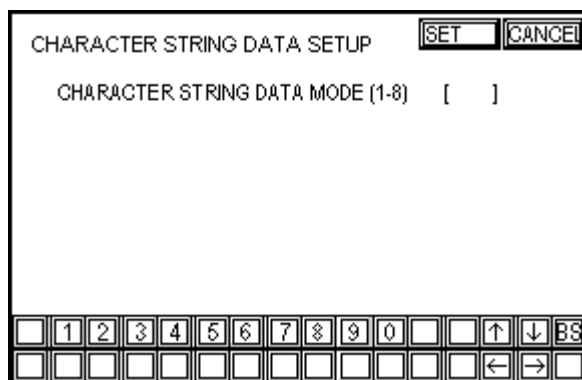

Be sure to designate the Character String Data order that matches your PLC type. Device Type and Tag settings cannot be entered.

Locate the data storage order for your PLC in the table below, and designate the CHARACTER STRING DATA MODE, based on the data in the following categories.

- I) Data's Device Storage Order
- II) Word's Internal Byte LH/HL Storage Order
- III) Double-word's Internal LH/HL Storage Order

### <CHARACTER STRING DATA MODE List>

I) Data's Device Storage Order	II) Word's Internal Byte LH/HL Storage Order	III) Double-word's Internal LH/HL Storage Order	Character String Data Mode
Store from Start Data	LH order	LH order	4
		HL order	2
	HL order	LH order	5
		HL order	1
Store from End Data	LH order	LH order	6
		HL order	7
	HL order	LH order	8
		HL order	3

I) Data Device Storage Order

E.g. Characters A B C D E F G H  
                   └─┘ └─┘ └─┘ └─┘  
                   ① ② ③ ④

• Store from Start Data

①	D0100
②	D0101
③	D0102
④	D0103

• Store from End Data

④	D0100
③	D0101
②	D0102
①	D0103

II) Word's Byte LH/HL Storage Order

E.g. Characters A B C D  
                   ① ② ③ ④

• 16-bit Device LH Order

②	①	D0100
④	③	D0101

• 16-bit Device HL Order

①	②	D0100
③	④	D0101

• 32-bit Device LH Order

②	①	④	③	D0100
---	---	---	---	-------

• 32-bit Device HL Order

①	②	③	④	D0100
---	---	---	---	-------

III) Double-word's Internal LH/HL Storage Order

E.g. Characters "A B C D E F G H I J"  
                   └─┘ └─┘ └─┘ └─┘ └─┘  
                   ① ② ③ ④ ⑤

• 16-bit Device LH Order

②	D0100
①	D0101
④	D0102
③	D0103
⑤	D0104

• 16-bit Device HL Order

①	D0100
②	D0101
③	D0102
④	D0103
⑤	D0104

## INITIALIZE

E.g. Characters A B C D E F G H I J K L M N O P Q R S T  
 ① ② ③ ④ ⑤ ⑥ ⑦ ⑧ ⑨ ⑩

• 32-bit Device LH Order

②	①	D0100
④	③	D0101
⑥	⑤	D0102
⑧	⑦	D0103
⑩	⑨	D0104

• 32-bit Device HL Order

①	②	D0100
③	④	D0101
⑤	⑥	D0102
⑦	⑧	D0103
⑨	⑩	D0104

### ■ Relationship between K-tag Write Character Values and PLC Device(s)

• With a 16-bit Device

The GP stores the character string from the start, in groups of 2, in the PLC's Device ① area.

When there are nine characters, they are arranged as follows.

1 2 3 4 5 6 7 8 9 NULL  
 └─┘ └─┘ └─┘ └─┘ └─┘



When the characters do not divide into 2 evenly, a NULL value is added.

• With a 32-bit Device

GP stores the character string from the start, in groups of 4, in the PLC's Device ① area.

When there are nine characters, they are arranged as follows.

1 2 3 4 5 6 7 8 9 NULL  
 └─┘ └─┘ └─┘



When the characters do not divide into 4 evenly, NULL value(s) is/are added.

## 5-4 SET UP I/O

This section describes the communication settings used with both the host PLC and any peripheral equipment. The SET UP I/O menu includes the SET UP SIO, SET UP I/O, and COMMUNICATION SETUP menu items.

### 1 SET UP SIO

This menu controls the PLC communication settings. Be sure to match the settings listed below with the SIO settings on the PLC host side.



Refer to *PLC Connection Manual Chapters 2 & 5, "Environment Setup" areas.*

SET UP SIO	SET	ESC
COMMUNICATION RATE	9600	
DATA LENGTH	8 / 1	
PARITY	OFF	
CONTROL	ER-CNTRL	
COMMUNICATION INTERFACE	4 LINE	

#### ■ COMMUNICATION RATE

The COMMUNICATION RATE (baud rate) is the data communication speed, measured in bits per second (bps), used between the GP and PLC.

#### ■ DATA LENGTH

For data communication, the DATA LENGTH (the first numeral) must be set to either 7 or 8-bits. The second value is the DESIGNATED BIT, which must be set to either 1-bit or 2-bits, depending on the DATA LENGTH setting.

#### ■ PARITY

Is used to set whether there is no parity check, or whether an odd or even number parity check is used during data communication.

#### ■ CONTROL

The CONTROL setting prevents the overflow of data. Select either X-CNTRL or ER-CNTRL.

# INITIALIZE

## ■ COMMUNICATION INTERFACE

Select one of the following options for the communication format: RS-232C, RS-422 (4 lines), or RS-422 (2 lines)



When using Memory Link format and an RS-422 cable, be sure to select the 4-line option.

## 2 SET UP I/O

Touch operation, system resetting, and GP display adjustments are made here.

COLOR GP-H70 SCREEN

SET UP I/O	<input type="button" value="SET"/>	<input type="button" value="ESC"/>
TOUCH OPERATION MODE	<input type="text"/>	
SYSTEM RESET MODE	<input type="text"/>	
CONTRAST SETTING	<input type="text"/>	

MONO GP-H70 SCREEN

SET UP I/O	<input type="button" value="SET"/>	<input type="button" value="ESC"/>
TOUCH OPERATION MODE	<input type="text"/>	
SYSTEM RESET MODE	<input type="text"/>	
CONTRAST SETTING	<input type="text"/>	
SET UP LCD	<input type="text"/>	

## ■ TOUCH OPERATION MODE

Designates either One Point or Two Point (i.e. two points must be touched simultaneously) touch input. Touching the right side's data field will toggle this setting.

## ■ SYSTEM RESET MODE

Designates whether or not a FORCED RESET can be performed.

To perform a FORCED RESET: While touching the bottom right corner (1) of the screen, also touch the upper right (2) and bottom left screen corners (3) to call up the SYSTEM RESET screen. Next, touch the RESET button.

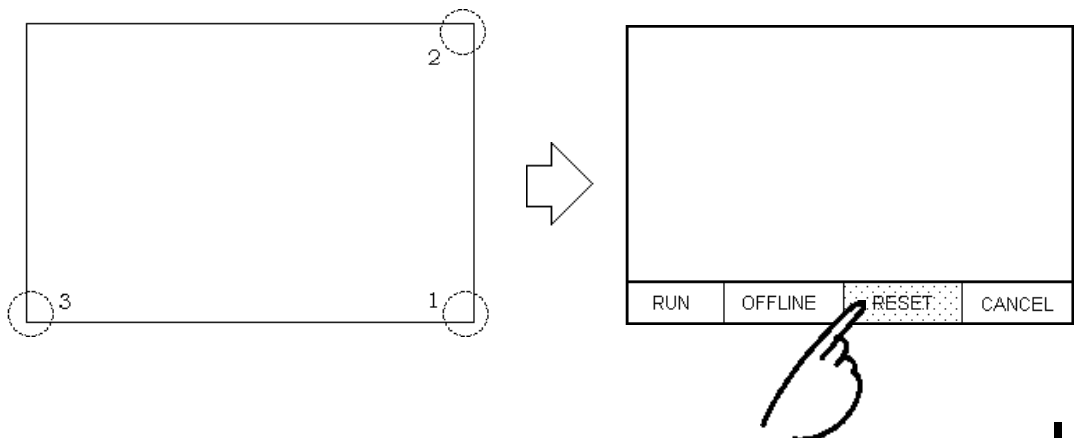



If [RESET] is touched, the GP-H70 is reset, whether it is in RUN or OFFLINE mode.



- The SYSTEM RESET mode cannot be entered while the GP is starting up.
- The SYSTEM RESET mode can be operated when normal GP RUN operations (PLC <--->GP communication) are not occurring.

## ■ CONTRAST SETTING

If this parameter is set to YES, you can adjust the contrast by simply touching the screen. To call up this screen, touch the panel's upper left (2) and right (1) corners. A contrast control bar will then appear at the bottom of the screen. The

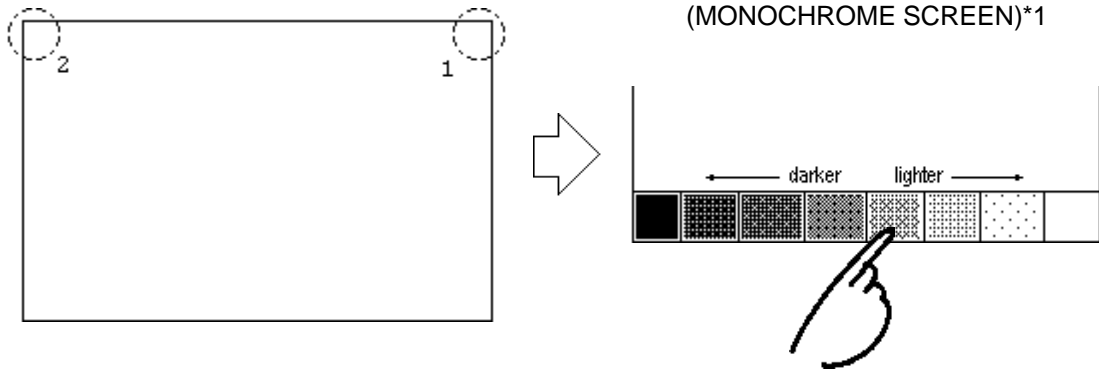

The above screen will be displayed with the GPH70-SC\*\*-24V models. If using GPH70-LG\*\*-24V models, the contrast control bar graduations will be in reverse order.



- To exit the CONTRAST ADJUSTMENT mode, touch anywhere outside the contrast option bar.
- The CONTRAST ADJUSTMENT mode cannot be entered while the GP is starting up.
- Contrast adjustments can be made even when RUN mode (PLC<--->GP communication) is in operation.

\*1 The darkness to lightness order is reversed for the color GP-H70.

## INITIALIZE

screen contrast will change depending on which contrast square you touch.

### ■ LCD SETTING (for GP-H70-LG\*\* only)

Touching this menu item's right side data field will toggle between two options: REVERSE display and NORMAL display. When REVERSE is selected, the screen's colors are inverted (right side screen).

Touch the LCD SETTING's right-hand square to change the GP's display from

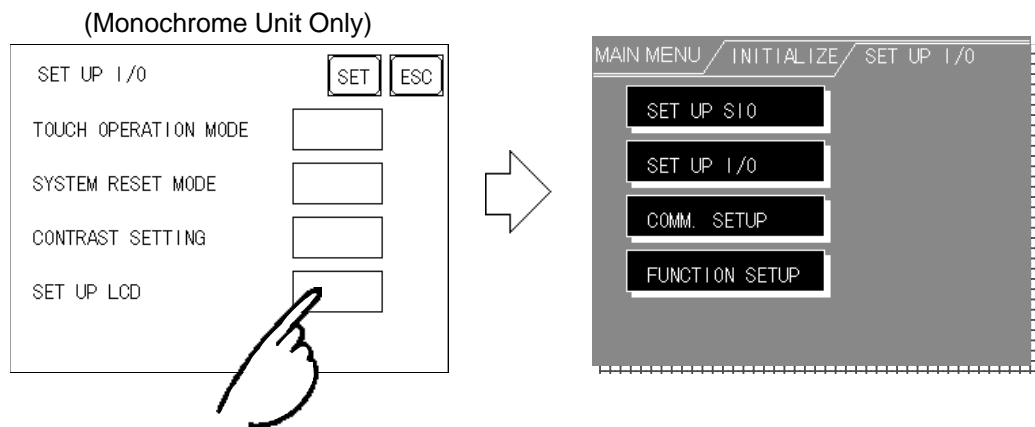

## 3 COMMUNICATION SETUP

NORMAL to REVERSE, then touch the SET button. The display colors will reverse and you will be returned to the previous screen.

The settings entered into these fields will be used after a GP<--->PLC communication error occurs and an error message is output. Using this feature ensures that an actual error has taken place, rather than a slight communications break or a slowdown in data processing by either the GP or the Host (PLC).

COMMUNICATION SETUP		SET	ESC
RECEIVE TIMEOUT (1~127)	10	sec	
RETRY COUNT (0~255)	2		

### ■ RECEIVE TIMEOUT

Designates how long the GP unit will wait after not receiving any data. (This is referred to as the "Timeout Time") However, if no data communication cable is connected, regardless of this setting, the Timeout value is automatically set to 1 second. The default value (used when a cable is connected) is 10 seconds.





When a value of over 30 seconds is set here, and screen data is transferred from the user's PC to the GP while a PLC Communication error has occurred, a communication error may also occur with the user's PC.

### ■ RETRY COUNT

When a PLC communication error occurs, this parameter determines how many times the GP-H70 will retry sending data before displaying an error message on the GP-H70's screen. The default (initial) value is 2. If communication is still not established after the GP-H70 has tried to send data the specified number of times, an error message will appear on the screen. Even if this message is displayed, the GP-H70 will continue to retry sending data until communication is reestablished.

## 4 FUNCTION SETUP

The user can set the operation switch to either enabled or disabled.

Touching the "Operation Switch" setting box toggles between "Enabled" and "Disabled." The default (initial) setting is "Enabled".

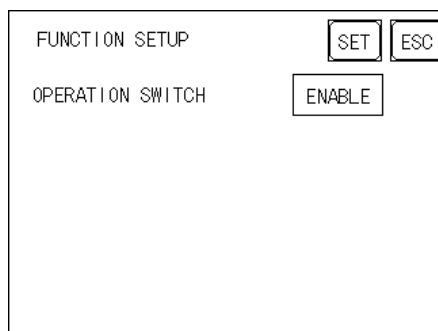

If the operation switch is set to "Enabled", you must touch the rear or front operation switch before you can use either the touch-panel or any of the function keys (see the table below).

If the operation switch is set to "Disabled", the front panel operation (OP.) switch will only work as a function key, and the rear panel operation switch is disabled.

Front operation switch	Rear operation switch	Result
OFF	OFF	Disabled
OFF	ON	Enabled
ON	OFF	Enabled
ON	ON	Disabled

## INITIALIZE

---

### DOUT

The DOUT feature is assigned to the F1 (DOUT0 output/DOUT0 ground) and F2 (DOUT1 output/DOUT1 ground) function keys.

The DOUT output varies depending on whether the operation switch is enabled or disabled.

OP. screen setting	OP. switch status	DOUT specification
<b>Enabled</b>	ON	Enabled (DOUT output is only possible when the OP switch is ON)
	OFF	Disabled (DOUT output is not possible even if the switch is pressed)
<b>Disabled</b>	ON	Enabled (DOUT output is possible regardless of the status of the OP switch)
	OFF	Enabled (DOUT output is possible regardless of the status of the OP switch)

## 5-5 PLC SETUP

This screen is used to designate the System Area and the Unit Number. Since **1:1** and **n:1** GP connections will use different settings, be sure to check that the current setting data matches the current connection type.



When using the GP-PRO/PBIII for Windows 95 (version 2.0 or later) “Simulation” feature, the GP’s “Setup Operation Surroundings” area cannot be used.

### 1 SET UP OPERATION SURROUNDINGS (1:1)

Enter the PLC System Data Area and Unit Number settings here.



These settings are necessary only when using the GP/PLC Direct Access format.

SET UP OPERATION SURROUNDINGS		SET	ESC
SYSTEM AREA START DEV		D	
START ADR		0	
UNIT NO.		0	
SYSTEM AREA READ SIZE		0	

#### ■ SYSTEM AREA START DEV/START ADDRESS

Designate the SYSTEM DATA AREA’s START ADDRESS. This area contains the PLC’s Data Register (D), Data Memory (DM), and other settings.



If your PLC allows multiple devices to be allocated, touch the **START DEV** entry field and a data entry keypad will appear.

#### ■ UNIT NO.

Enter the PLC Unit number here. Be sure it matches the number used in the PLC.

#### ■ SYSTEM AREA READ SIZE

When using a Block Display Trend Graph, be sure to designate a Read Area Size (in word units) that matches the Trend Graph’s data size. The read area is allocated immediately following the system data area setting(s). Use this setting

## INITIALIZE



- If you do not plan to use the Read Area, please do not change the default “0” values. This will allow high speed data communication to be performed.
- When using Hitachi’s HIDIC-S10 $\alpha$  Series, an extra item, titled the “Extended Memory Address (HIDIC) [000000]” will be added to the above screen display. Values accepted by the extended memory start address are **0** (memory not extended), and **100000 to 1FF000** (HEX).



- When using the Matsushita Electric Company’s NEWNET-FP, an extra item, titled “Monitor Register,” is added to this screen. When using two (2) or more CCU’s (communication units), as shown in the following diagram, with a GP connected to each CCU, select the **1:1** connection type and designate the Monitor Register as “None.”

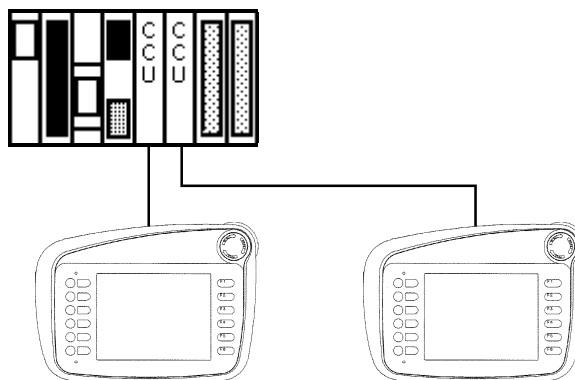

- When connecting a single GP, designate the Monitor Register as “Yes.”

## 2 SET UP OPERATION SURROUNDINGS (n:1)

when you wish to designate the PLC Data Register (D), or Data Memory (DM) read areas.



This screen designates the settings used for the SYSTEM DATA AREA and UNIT NO. with an **n:1** (multi-link) PLC connection.



These settings are only necessary when using the Direct Access format.

SET UP OPERATION SURROUNDINGS		SET	ESC
SYSTEM AREA START DEV	D		
START ADR	0		
UNIT NO.	0		
SYSTEM AREA READ SIZE	0		

For more information about the **n:1** (multi-link) connection's SYSTEM DATA AREA, refer to *PLC Connection Manual 4-6, "SYSTEM AREA SETUP"*.

### ■ SYSTEM AREA START DEV/START ADDRESS



If your PLC allows multiple devices to be allocated, touch the START DEV. entry field and a data entry keypad will appear.

Designates the SYSTEM DATA AREA's START ADDRESS. This area contains the PLC's Data Register (D), Data Memory (DM), and other data.

### ■ UNIT NO.

Enter the PLC Unit number here. Be sure it matches the number used in the PLC.

### ■ SYSTEM AREA READ SIZE

When using a Block Display Trend Graph, be sure to designate a Read Area Size (in word units) that matches the Trend Graph's data size. The read area is allocated immediately following the system data area setting(s). This setting is used to designate the PLC Data Register (D), or Data Memory (DM) read areas.



If you do not plan to use the Read Area, please do not change the default "0" values. This will allow high speed data communication to be performed.

## 3 STATION SETUP

STATION SETUP data, which is required for **n:1** (multi-link) systems, checks whether data communication is being performed correctly within the network configuration.

STATION SETUP	SET	ESC
NETWORK INFORMATION DEV	D	
INFORMATION ADR	1	
STATION No. (0-15)	0	

## INITIALIZE

### ■ Network Information Storage Devices and Addresses

With a **n:1** (multi-link) connection, network information is transmitted in two (2) word units. These units consist of a Connection List and a Verification List (shown below). This data is used to allocate transmission data into the PLC's Data Register (D) and Data Memory (DM), respectively.

Be sure to specify only addresses which do not overlap the system data area addresses.

PLC Data Register Design

+0	CONNECTION LIST	PLC-->GP
+1	VERIFICATION LIST	GP-->PLC



In the NETWORK INFORMATION ADDRESS area, use the same address to designate all the GP's connected to the same link unit (PLC). Also, when the connected link unit (PLC) has two (2) ports, be sure the PLC addresses used are different.

### ◆ Connection List

The Connection List's word address designates the number of GP's connected to the PLC, which must be registered beforehand in the PLC. When these GP's are then physically connected to the PLC, the corresponding PLC bit numbers for the particular GP Stations (see below) turn ON.



When the GP is connected to the PLC and the GP ONLY transmission option finishes, when OFFLINE mode is reentered, the GP Station Number turns the corresponding PLC bit OFF.

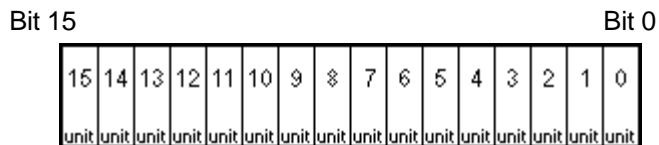

For example, when the following four (4) GP units - represented by bits 0, 2, 3, and 5 - are connected, the value 002D (h) is written to the Connection List.

Connection List 

0	0	0	0	0	0	0	0	0	0	0	0	1	0	1	1	0	1
---	---	---	---	---	---	---	---	---	---	---	---	---	---	---	---	---	---

 002D (h)



- Be sure to designate these settings before running the GP.
- Turn all bits not connected to the GP OFF.

### ◆ Verification List

This area responds to data transmission from each connected GP. When the bit numbers corresponding to those used by the Connection List turn ON, the data transmission is recognized by the Verification List. In turn, the PLC bit numbers corresponding to the Station Numbers of the communicating GPs turn ON.

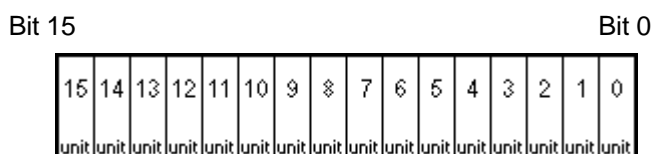

If data transmission between the GP(s) and PLC is being performed correctly, the same value in the Connection List will write to the Verification List.

For example, the value 002D (h) in the Connection List, designated as bit 0, bit 2, bit 3, and bit 5, will be written to the Verification List, as shown below.

Connection List 

0	0	0	0	0	0	0	0	0	0	0	1	0	1	1	0	1
---	---	---	---	---	---	---	---	---	---	---	---	---	---	---	---	---

 002D (h)

Verification List 

0	0	0	0	0	0	0	0	0	0	0	1	0	1	1	0	1
---	---	---	---	---	---	---	---	---	---	---	---	---	---	---	---	---

 002D (h)



- When the Connection List and Verification List data values do not match, a **COMMUNICATION ERROR** occurs. Recheck all related settings.
- When changing the current connection, first turn all the data bits OFF.
- Even if the GP-H70 is connected, no communication is performed (no error is displayed) when the Connected Station List's setting is set to OFF.

### ■ STATION NO.

This menu item designates the number of GP Stations in use. The designated range is from 0 to 15, with the only restriction being that each GP STATION NO. used must be unique within the system. If STATION NO.'s are repeated, a **COMMUNICATION ERROR** will occur.



Your unit's station number is simply a unique number assigned to a single GP-H70. It has no connection to the link unit number.

## 4 CUSTOMIZE SETUP

The Customize function can be used to adjust the **n:1** (multi-link) connection's communication method to make it more effective. To communicate more efficiently, decide whether to use the Operation or Display priority feature on your GP. As a result, the communication response speed can be improved, though the amount of improvement will depend on the type of information being displayed.

CUSTOMIZE SETUP		SET	ESC
PLC PRIORITY		OPE.	
GP TOUCH MONOPOLIZE		OFF	
MONOPOLIZE TIME		0	*10 sec

### ■ PLC PRIORITY

Depending on how the GP is used, select either the Operation priority (OPE.) or Display priority setting.

### ◆ Display (DISP.)

Designate this option when using the GP primarily as a monitor. The GP will operate at a higher display speed as a result; however, the response time for the touch panel's operations will slow.

### ◆ Operation (OPE.)

Designate this option when using the GP primarily as an operation panel. As a result, the touch panel's numeric input and switch response times will improve.

Leaving the GP in this mode does not significantly influence the touch panel response time of the rest of the GP's, however, their screen display refresh cycles will slow.



- In a standard configuration of GPs, use the same settings for all connected GP's.
- To increase a GP's display speed, be sure to use consecutive addresses wherever possible. With bit addresses, use consecutive word units.



### ◆ Display Priority and Operation Priority Speed Differences

When using the Mitsubishi Electric Corporation's A3A PLC, with a scan time of 20ms and consecutive addresses (80 words, not including the System Area), the difference in reading speed is as shown in the following graphs.

Display Priority and Operation Priority Speed Differences

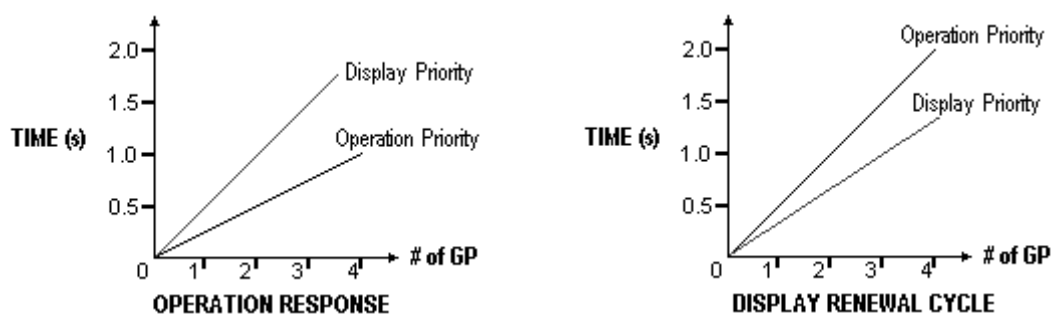

### ■ GP TOUCH PANEL MONOPOLIZE

The touch panel monopolization feature can be set to either ON or OFF. When the Touch Panel has been set to momentary operation and you want to use the PLC exclusively, turn the GP TOUCH MONOPOLIZE feature ON.



Refer to *PLC Connection Manual 4-5, "About PLC Monopolize"*

When this feature is ON, the touch panel uses the PLC exclusively whenever the Touch Panel's momentary operation feature is touched. In this way, you can use a momentary switch to perform machine inching operation. When the momentary feature is pressed again, exclusive use ends.

### ■ MONOPOLIZE TIME (0~2550 sec.)

Monopolize operation begins when the GP System Data Area's word address LS14's 7th bit turns on, and ends either when this bit turns OFF, or when the set time value elapses. The input range is 0 to 255. The actual value is 10 times this setting number, so the actual period of time can be 0 through 2550 seconds, in ten second intervals.



- Touching the touch panel during the monopolize period interrupts the MONOPOLIZE TIME function, and ends exclusive use.
- When MONOPOLIZE TIME is set to 0, the monopolize function does not automatically finish.



For further information about the contents of System Data Area's LS6 (status) and LS14 (control) bits, refer to the *PLC Connection Manual 1-1, "Contents and Range of System Area"*.

### 5-6 INITIALIZE INTERNAL MEMORY

This command erases all the GP screen data in memory.



- You cannot cancel the Initialization procedure once the Start key is touched.
- Initialization does not erase the SYSTEM SET UP, SIO protocol, or internal clock data.

**INITIALIZE INTERNAL MEMORY** ESC

**WARNING: PREVIOUS DATA WILL BE  
OVERWRITTEN!**

**ENTER PASSWORD AND PRESS  
START KEY ?**

**START**

To initialize the GP's internal memory, enter the common password **1101**, or the password entered in the **SYSTEM SET UP** screen.



Initialization takes 10 to 20 seconds.

## 5-7 SET UP TIME

This area contains the time values used for the GP's internal clock. Use this screen to enter the current date and time settings (year should be last 2 digits only).

SET UP TIME	SET	ESC
PRESENT TIME		
'95 Y 1 M 15 D 22:16		
TIME SET UP		
'95 Y 1 M 15 D 22:16		



NOTE

- The time value displayed on the GP screen will need occasional correction to remain accurate. At room temperature, the GP's internal clock has an accuracy of  $\pm 65$  seconds/month. The surrounding temperature and age of the unit can reduce the accuracy to +95 to -380 seconds/month. However, since the Screen Time's display is in minute units, this degree of error may not be crucial.

**5-8 SET UP SCREEN**

Here, the settings used for the initial screen display shown on powering up, the character size used for alarm messages, and other related items are designated.

<b>SET UP SCREEN</b>		<b>SET</b>	<b>ESC</b>
<b>INITIAL SCREEN NO.</b>	<b>B</b>	<input type="text" value="1"/>	
<b>ALARM MESSAGE</b>	<b>V SIZE</b>	<input type="text" value="1"/>	
	<b>H SIZE</b>	<input type="text" value="1"/>	
<b>ONLINE ERROR DISPLAY</b>		<input type="text" value="ON"/>	

■ **INITIAL SCREEN NO.**

Here, you can enter the number of the screen file that first appears when the unit is powered up. If the **SYSTEM SET UP** area's **DATA TYPE OF SCREEN NO.** field's **BIN** option has been selected, you can enter a number from B1 to B8999. If **BCD** has been selected, input a number from B1 to B1999.

■ **ALARM MESSAGE**

Designates the size of the letters displayed in the **ALARM MESSAGE**.

The character size can be set to 1, 2, or 4 times size, for both the height and width.

1	2	4
Height=1; Width=1 16 x 8 pixels	Height=2; Width=2 32 x 16 pixels	Height=4; Width=4 64 x 32 pixels

■ **ONLINE ERROR DISPLAY**

Designates whether or not error messages will display during **RUN** mode.

■ **FONT SETTING**

## 5-9 FONT SETTING

Use this dialog box to set the font you wish to display during RUN mode.

FONT SETTING

FONT SETTING I-ASCII

KANJI FONT QUALITY HIGH

Select the type of font to be used by the GP during RUN mode. The options available include ASCII, Korean, Taiwanese, Chinese, and Japanese.

### ■ KANJI (Chinese character) FONT QUALITY

When the kanji character quality is set to HIGH, any character larger than a full sized 2 x 2 character will display as a 32-dot character. When STANDARD is selected, the display becomes a simplified 16-dot font.



- The Kanji Font Quality setting can only be used when the FONT SETTING has been set to JAPANESE.
- When the HIGH quality setting is used, Level 1 JIS Kanji Code standard is represented. Level 2 standard characters, no matter what the current font setting is, will always display using 16 dots.

## 6

## RUN and Errors

6-1 GP RUN Mode

6-3 SELF-DIAGNOSIS

6-2 Troubleshooting

6-4 Error Messages

This chapter describes GP RUN mode, and a variety of troubleshooting processes.

## 6-1 GP RUN Mode

There are two ways of entering RUN mode, one being after the unit (GP) powers up, and the other being from OFFLINE mode.

### 1 After Powering Up

Connect the GP unit's power cord terminals. After the unit has powered up, the START TIME value designated in the INITIALIZE/SYSTEM SET UP area determines how long the display, shown below, appears before it is replaced by the next screen. This next (designated) screen's number was entered in the INITIALIZE/SET UP SCREEN menu. If, however, the screen designated does not exist, the following initial screen will remain displayed.

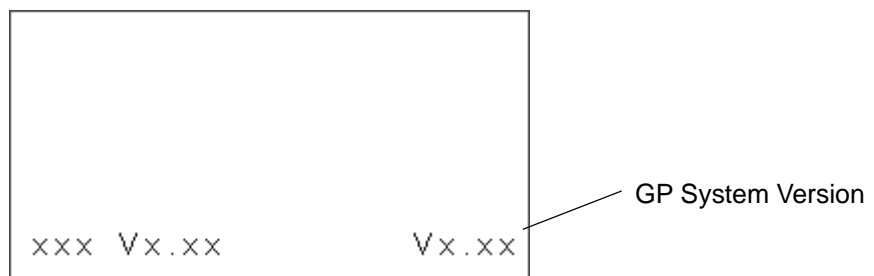

## 2 OFFLINE Mode

Here, simply touch the MAIN MENU's RUN selection to begin GP operation. The INITIALIZE/SET UP SCREEN option setting will designate the first screen that appears in RUN mode, when communication with the PLC begins. However, if the designated screen does not exist, the initial screen will remain displayed.

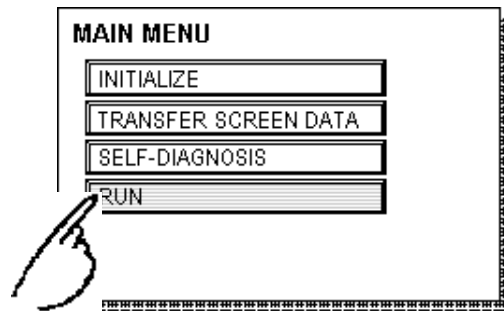

After the GP's power is turned ON, pressing the top left corner of the GP's screen within ten seconds will automatically switch the unit to OFFLINE mode.

E.g.) After the GP powers up, if the User's initial screen displayed has an object (in this example a screen-change switch) in the top left corner, and this object (switch) is touched within 10 seconds of the screen being displayed, the GP will change from RUN mode to OFFLINE mode, not to the User's desired screen.

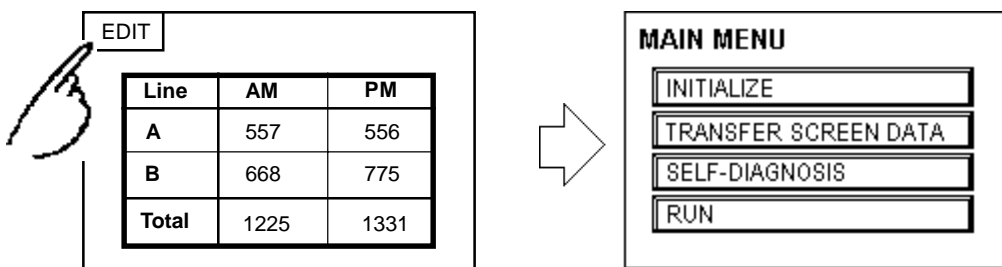

# 6-2 Troubleshooting

This section describes how to identify and resolve problems that may occur with the GP. If there is a problem with the PLC, please refer to that PLC maker's manual.

## 1 GP Problems

The following are possible problems that may occur while using the GP.

**(1) No Display**

No display appears when the GP's power cable is connected. Also, during RUN mode, the screen disappears.

**(2) No Communication**

The GP unit cannot receive data from the Host (PLC). An error message may appear on the screen as a result.



For further information about error messages, refer to **6-4, "Error Messages"**.

**(3) Touch Panel Does Not Respond**

The touch panel does not respond when touched, or the response time is very slow.

**(4) OFFLINE message displays during RUN Mode**

For problems (1) to (3), refer to the flowcharts on the following pages.

For problem (4), a **SYSTEM ERROR** may have developed that caused the OFFLINE mode screen to appear.



Refer to **6-4-2, "Error Messages - Details"**

However, if this screen appears after entering OFFLINE mode (by touching the top left corner within ten seconds of powering up), the unit is operating normally.



### WARNING

**Prior to performing any adjustments to the GP's wiring:**

**Because of the possibility of an electric shock, be sure the GP's power cable is not plugged into the main power supply.**



This section assumes that the GP is the cause of the problem, not the Host (PLC). When, however, the Host (PLC) is the problem, please refer to the PLC maker's manual.



## 2 No Display

Use the flowchart below to diagnose why no display appears after the GP's power cable is connected, or, when the screen turns OFF by itself during RUN mode.

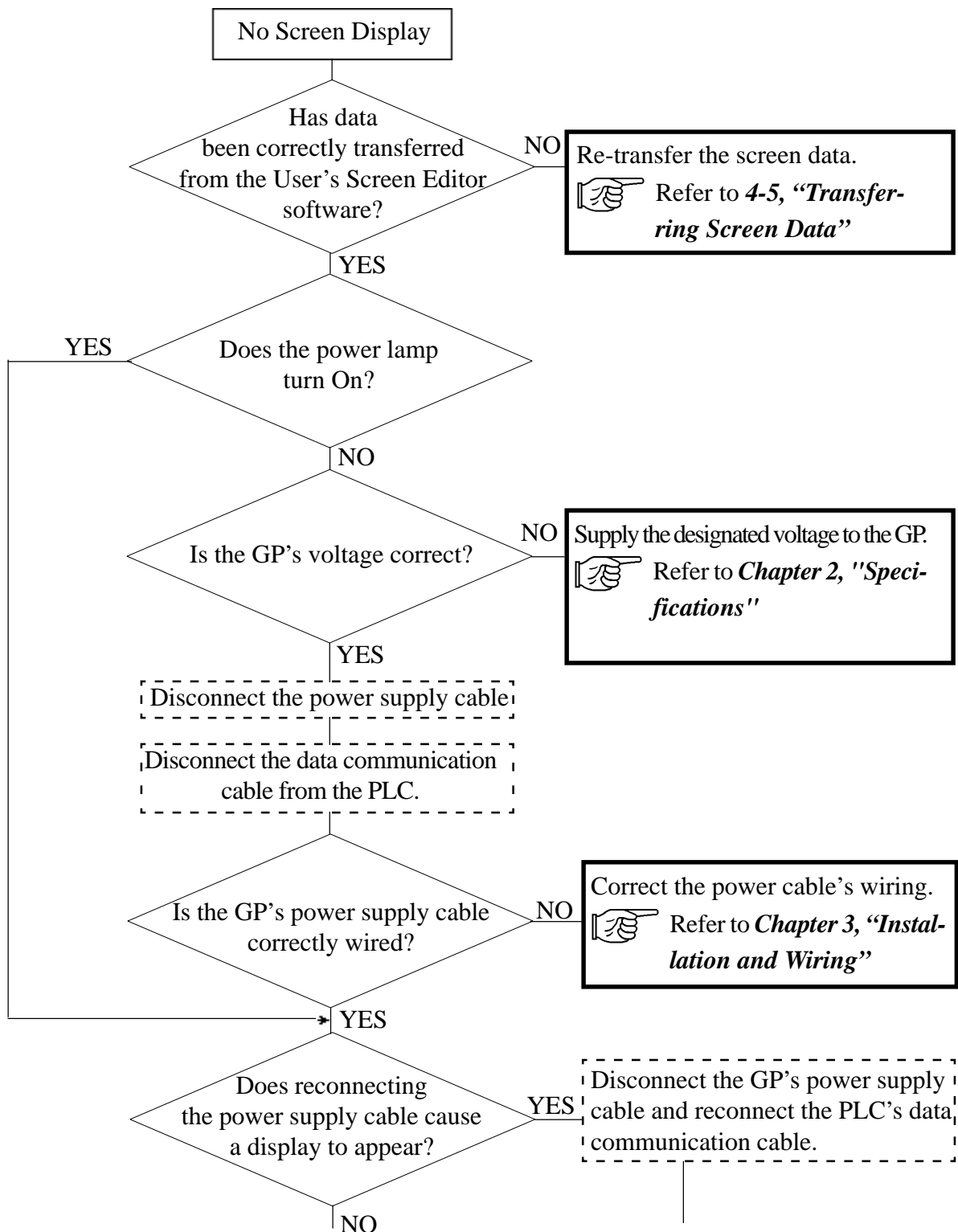

# RUN and Errors

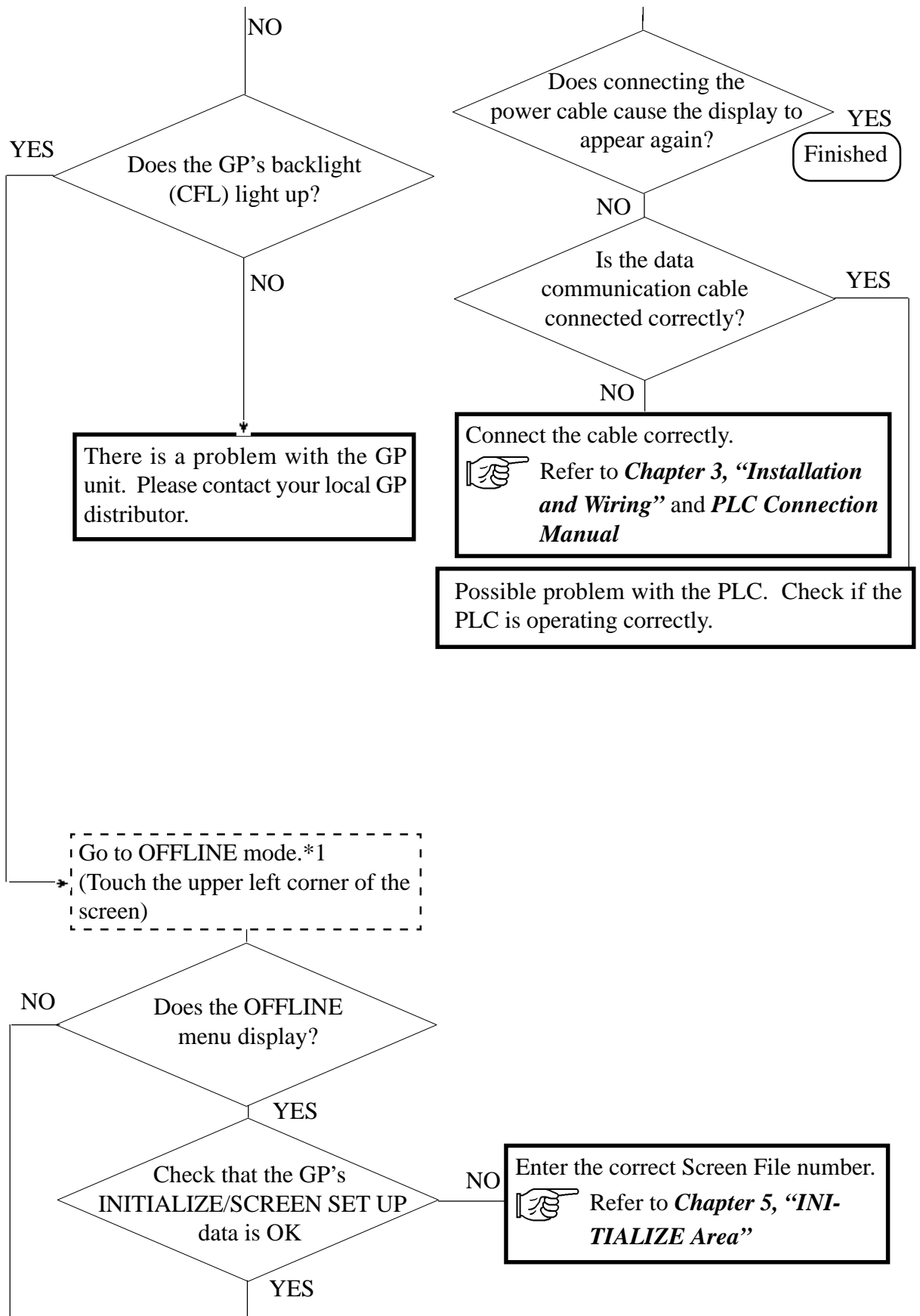

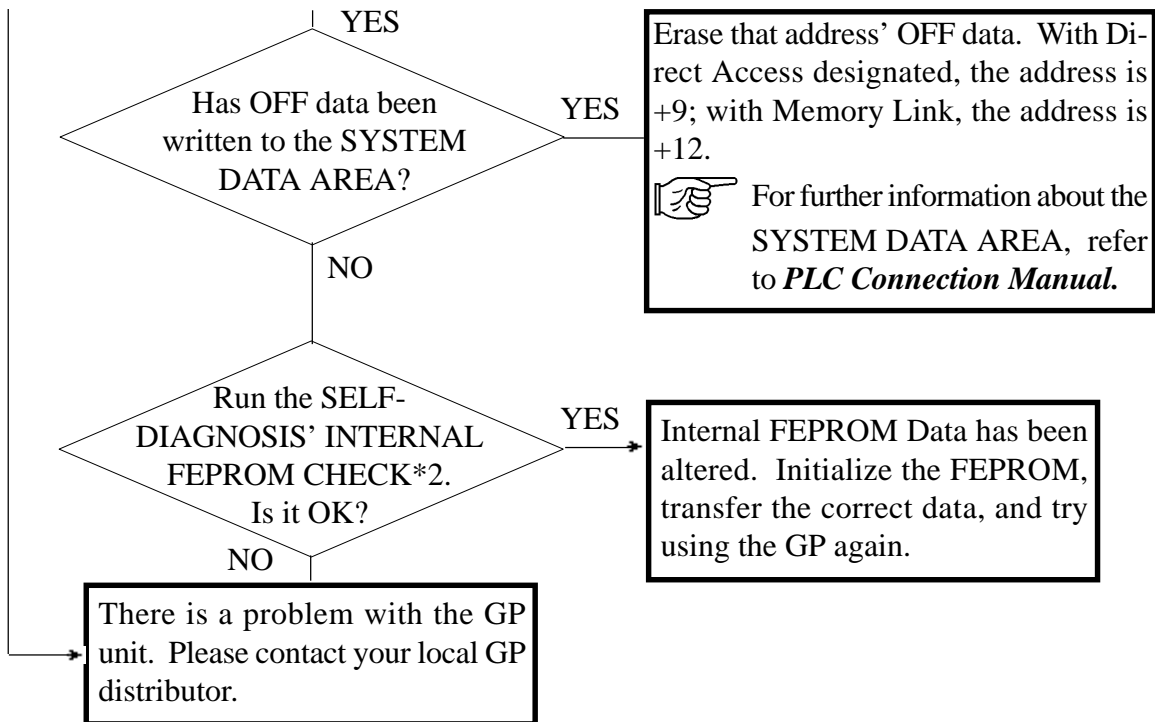

\*1 To make the GP's OFFLINE screen appear, disconnect the power cable, reconnect it, then touch the upper left corner of the screen within 10 seconds of reconnecting the power cable.

\*2 Running the FEPRM check will erase all the current screen data. Be sure to make a backup of all screen data prior to running this check.

### 3 Cannot Communicate With Host (PLC)

When the GP cannot communicate with the Host (PLC), use the flowchart below to diagnose the problem.

Also, if an error message appears on the screen, refer to the error code list.



Refer to 6-4, “*Error Messages*”

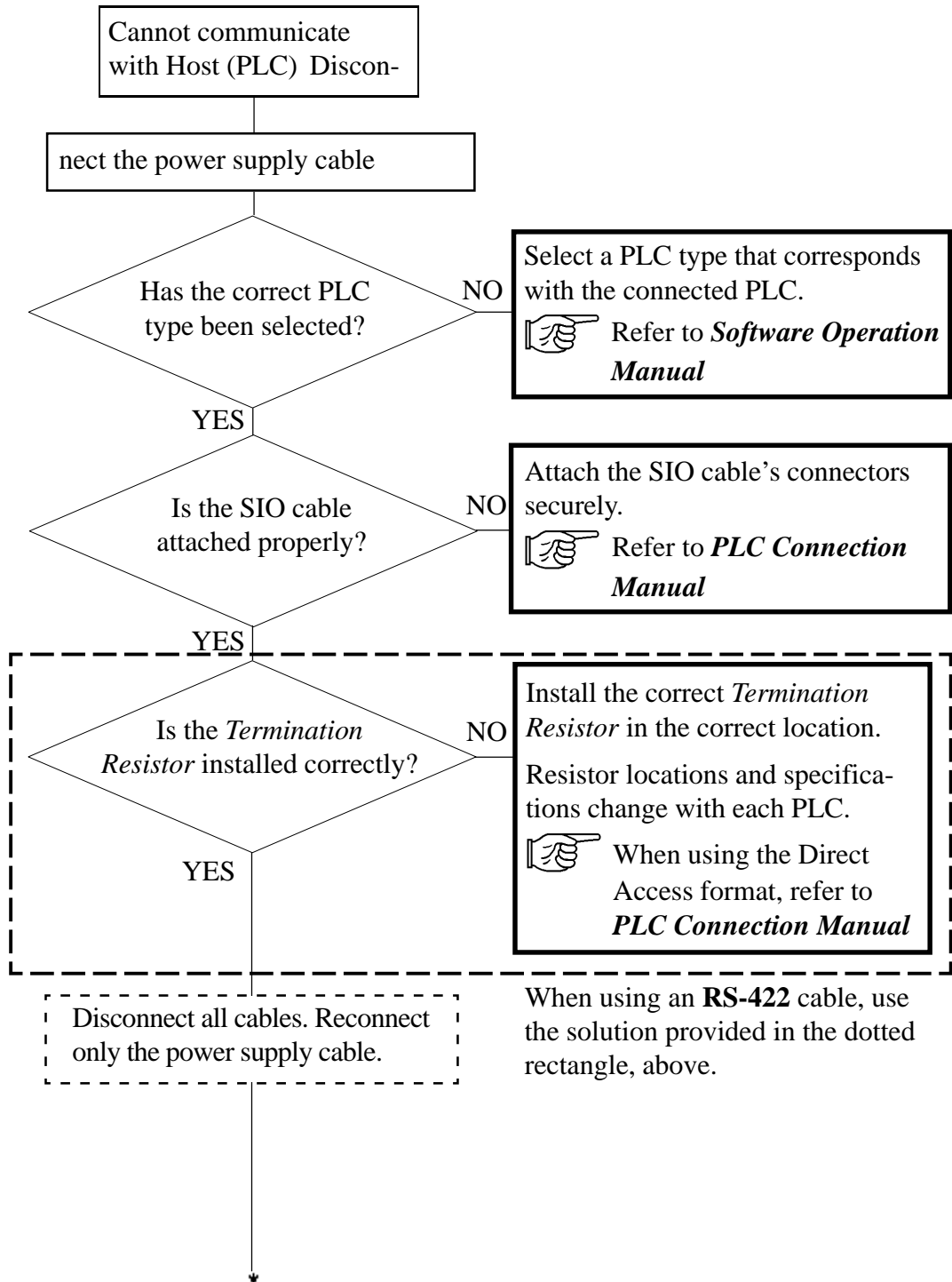

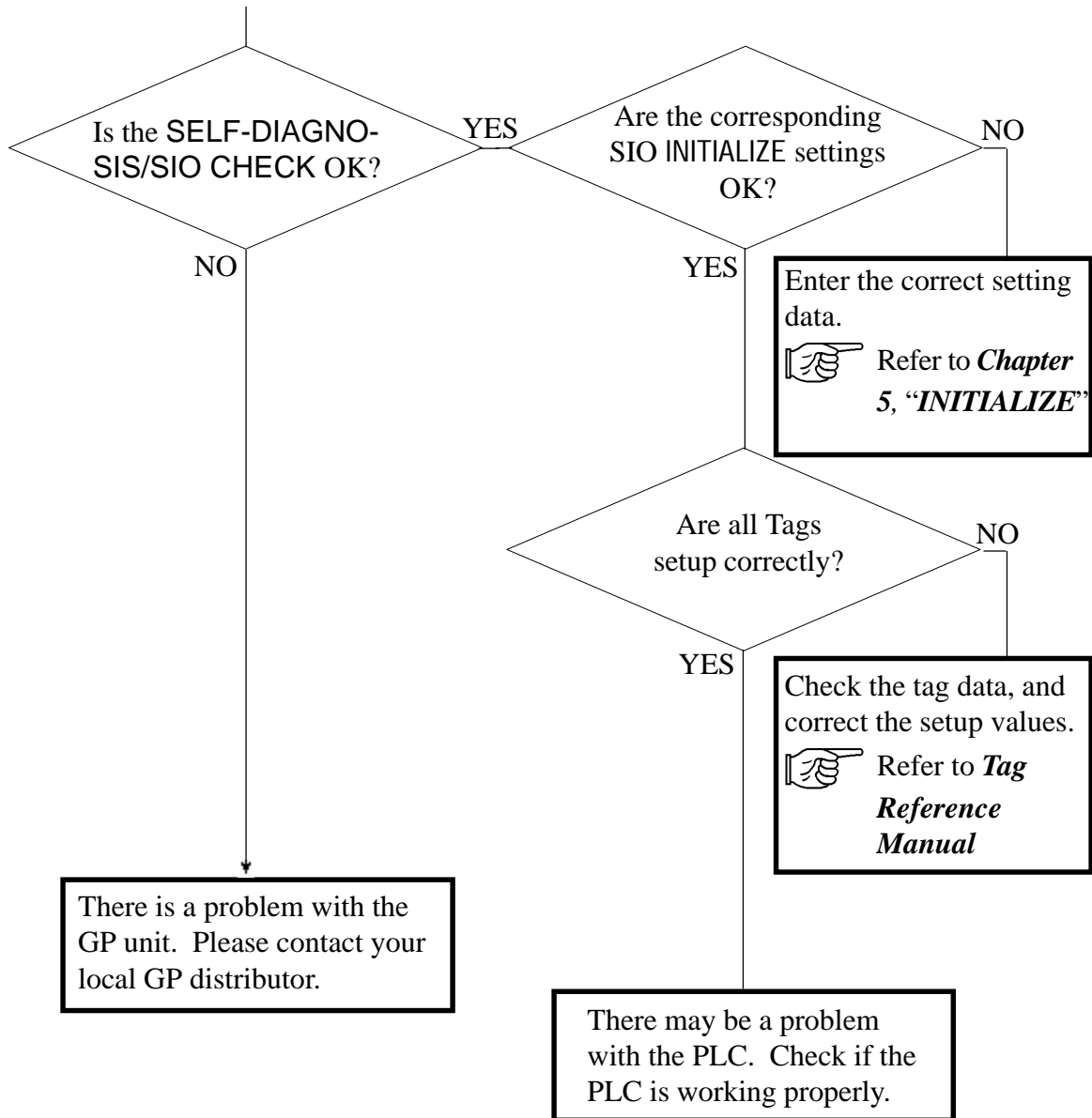

**NOTE** To run the SELF-DIAGNOSIS SIO CHECK options, special equipment is required.

For details about performing the SELF-DIAGNOSIS, refer to this chapter's **SELF-DIAGNOSIS** section.

## 4 When Touch Panel/Function Keys Do Not Work

When the touch panel/function keys do not respond, or its response time is very slow, please use the flowchart below to diagnose the problem.

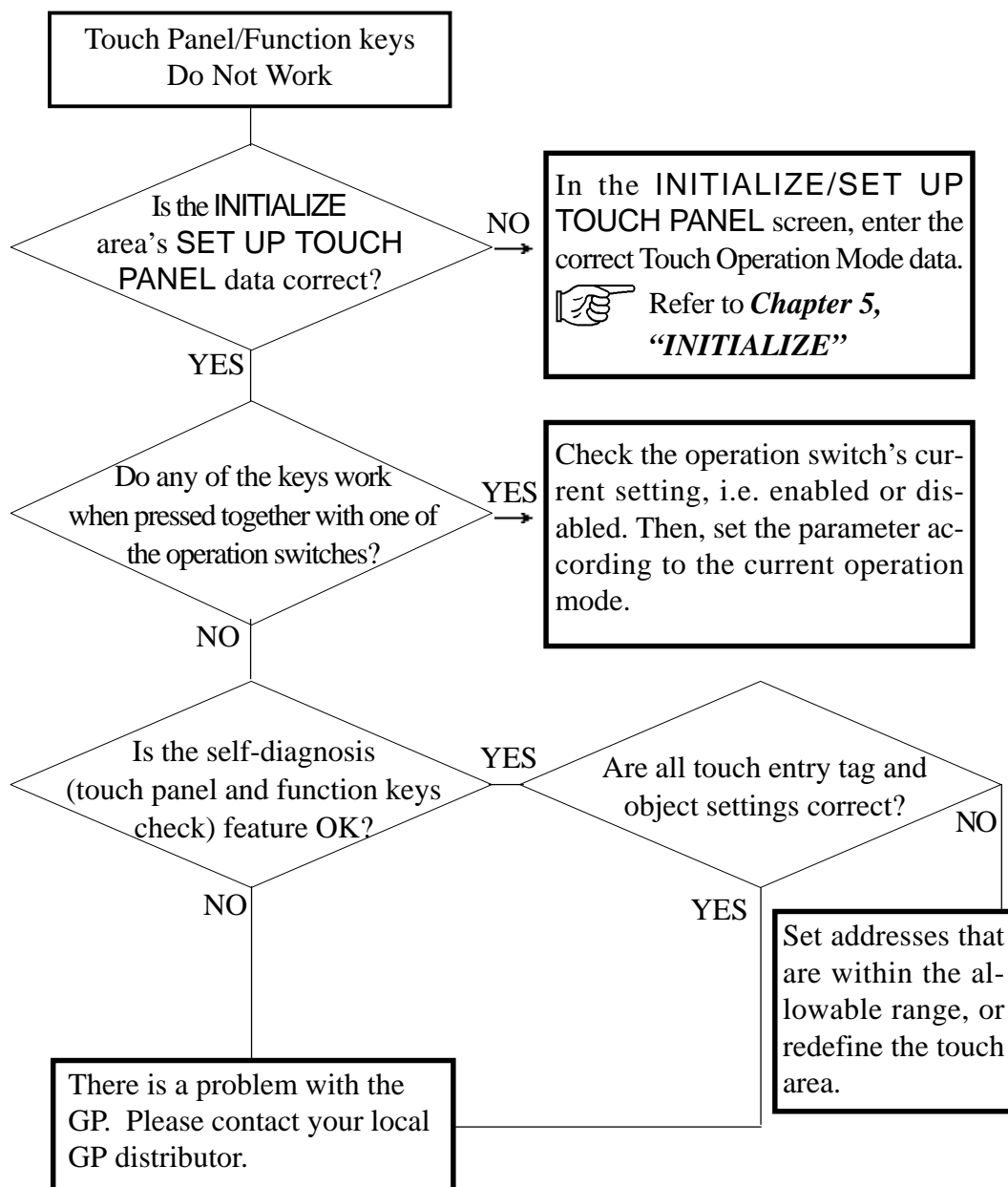

## 6-3 SELF-DIAGNOSIS

The GP is equipped with System and Interface diagnostic programs. Use this area as a first step in solving most GP problems.

### 1 SELF-DIAGNOSIS Features

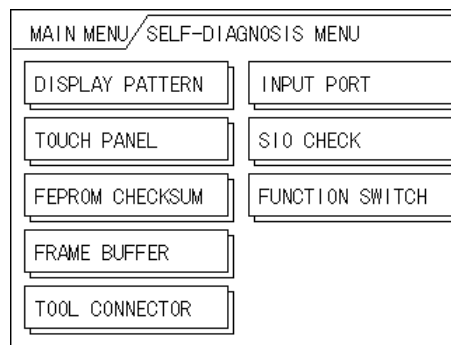

#### DISPLAY PATTERN

Displays all the screen's shapes and tiling patterns to check if they are correct.

#### TOUCH PANEL

Checks the touch panel squares.

#### FEPR0M CHECKSUM

Runs the GP internal memory's (FEPR0M) system and protocol checksum.

#### FRAME BUFFER

Checks the GP internal display memory (FRAME BUFFER).

#### \*TOOL CONNECTOR

Checks the tool connector's control lines and input/output lines.

#### INPUT PORT (for Digital's maintenance use only)

Checks the status of the Input Port.

#### \*SIO CHECK

Checks the input/output lines for the RS-232C and RS-422 terminals.

#### FUNCTION SWITCH

To perform this check, press a function key on the GP-H70 and then verify whether the corresponding part is displayed on the screen in reverse video.



All SELF-DIAGNOSIS items marked with an asterisk (\*) require special, user-supplied equipment.

## 2 SELF-DIAGNOSIS - Detailed Explanation

This section explains the details of the GP's SELF-DIAGNOSIS feature.



For information about how to operate this screen, refer to *Chapter 4, "OFFLINE Mode"*.



For information about how to set up any special equipment required, refer to *Chapter 3, "Installation and Wiring"*.

### DISPLAY PATTERN

This feature checks the screen drawing functions. If device's information is incorrectly displayed or if the GP's buzzer does not sound, this check should be performed. During the check, various screen patterns will be displayed and a "Display ON/OFF check" is performed. During this check, the buzzer turns OFF and ON together with the screen. If this function is normal, the characters "OK" will appear. If anything abnormal is found, "NG" will appear.

### TOUCH PANEL

Checks if each touch cell highlights when touched.

### INTERNAL FEPROM CHECKSUM (System & Protocol)

The Internal FEPROM System and Protocol check searches for any problems that may have arisen during GP operation. If the FEPROM is normal, **OK** displays; if there is a problem, an error message appears. Performing this check does not erase any System or Protocol data.

### FRAME BUFFER

This feature looks for any display (memory) problems that may have developed. If everything is normal, **OK** will appear; if there is a problem, an error message will appear.

### TOOL CONNECTOR LOOP BACK

The Tool Connector Control line and Send/Receive line check is used when the GP cannot send or receive data normally from the PC. To perform this check, a Tool Connector Check Loop Back Cable (Dsub25 pin female connection) must be connected to the Data Communication Cable. Refer to the diagram on the next page.

If everything is normal, **OK** will appear; if there is a problem, an error message will appear.

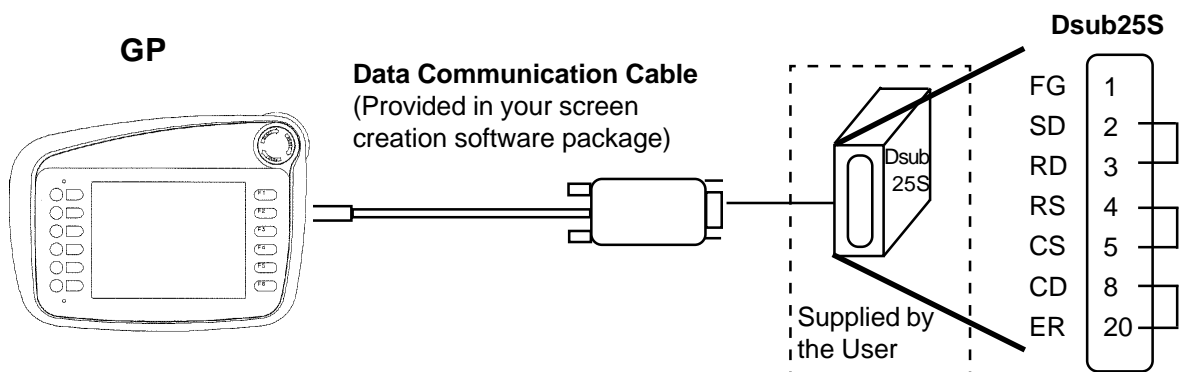



### INPUT PORT

Used by Digital for maintenance purposes.

### SIO CHECK

Checks the RS-232C and RS-422 I/O cables to identify areas where data transfer problems may have developed. Select which type of check to run from the menu. In order to run this check, a serial interface cable is used (connected). If the cable is normal, **OK** displays; if there is a problem, an error message appears.

The serial interface (SIO) cable's wiring for each type of check is as shown below.

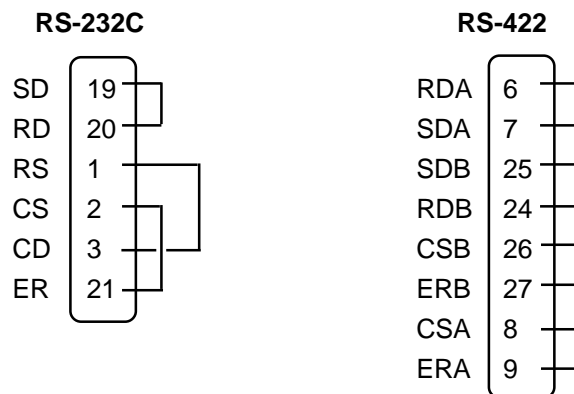

### FUNCTION SWITCH

To perform this check, press a function key on the GP-H70 and then verify whether the corresponding area is displayed on the screen in reverse video.

### 6-4 Error Messages

This section describes each error message that can appear during the operation of the GP-H70. The origin of each error message's problem is explained, along with suggested ways of correcting the error.

After a GP problem has been diagnosed, unplug the GP's power cable, then re-connect it to restart the unit.

#### 1 Error Message List

The following list shows the different error messages that can appear on the GP unit. Instructions on how to find and solve the problems indicated by these error messages are explained in the following pages.

- SYSTEM ERROR
- ILLEGAL ADDRESS IN SCREEN DATA
- UNSUPPORTED TAG IN SCREEN DATA
- PLC NOT CONNECTED (02:FF) and (02:F7)
- PLC NOT RESPONDING (02:FE)
- RECEIVE DATA ERROR (02:FD)
- PLC COM. ERROR
- SCREEN MEMORY DATA IS CORRUPT
- CLOCK SETUP ERROR
- SCREEN TRANSFER ERROR
- THE MAXIMUM NUMBER OF TAGS HAS BEEN EXCEEDED
- OBJ. PLC HAS NOT BEEN SETUP

For **n:1** connections:

- GP STATION NO. DUPLICATION ERROR (02:F9)
- NETWORK ADDRESS ERROR (02:F8)



If more than one error occurs, the GP displays the error message for the last error detected.

## 2 Error Messages - Details

### ■ SYSTEM ERROR

Indicates a basic GP operation error has occurred.

Just after the error message, an error code, as shown below, will appear. Please report the error number, together with any details on how the error might have developed to your local GP distributor.

### ◆ SYSTEM ERROR ( 03 : x x )

This message is displayed if a unrecoverable error occurs when data is transferred from the personal computer.

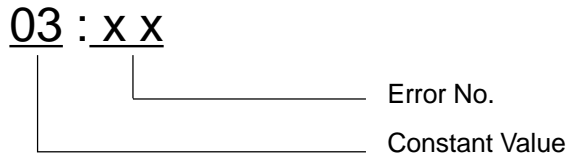

### ◆ SYSTEM ERROR ( x x x : x x x : x x x )

Displays in RUN mode when an unrecoverable error occurs.

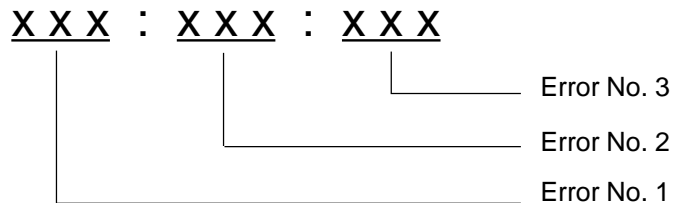

### ◆ OFFLINE mode displays during RUN mode

When the GP suddenly changes to OFFLINE mode without the user having touched the screen, it is possible that the GP's screen data settings have become corrupted. When this happens, after a SYSTEM ERROR is displayed, the screen automatically reverts to OFFLINE mode after approximately 10 seconds. In this case, run the GP's INITIALIZE MEMORY command and then resend the screen data from your PC to the GP.

## RUN and Errors

### ■ ILLEGAL ADDRESS IN SCREEN DATA

This error message is caused when address values overlap.

Just after this error message, certain error codes, as shown below, will appear. If the error cannot be fixed, please report this error code and any information as to how the error developed to your local GP distributor.

### ◆ ILLEGAL ADDRESS IN SCREEN DATA ( 0 0 B : x x x : x x x )

0 0 B : x x x : x x x

Error No. 2 (See table below)

Error No. 1

### <Overlapping Addresses>

Error No. 1	Error No. 2	Meaning
0C1	191	All or part of the T-File*1 or S-tag address ranges are overlapping System Data Area addresses.
	192	
	193	
0C2	194	All or part of the System Data Area, A-File, or, S-tag address ranges are overlapping a T-file's addresses.
	195	
	196	
0C3	197	All or part of the T-File*1, S-tag or K-tag address ranges are overlapping the address ranges set in an A-file.
	198	
	199	
0C9	19B	All or part of the T-File*1, S-tag or K-tag address ranges are overlapping the address ranges set in a Log Alarm.



Overlapping addresses, other than the ones mentioned above, can also cause the Illegal Address message to appear.

E.g. When the starting address of the System Data Area is set to 100, and a tag is designated as follows:

Tag Name/ Part ID No.	Word Address	Tag Format
N1	99	BCD32

Here, the N-tag's format has been set to 32 bits, meaning it uses two consecutive word addresses. Therefore, since the first address is 99, the second address must be 100. Address 100, however, cannot be used since it has already been reserved for the System Data Area.



\*1 For details about setting up T-files (trend graph) and A-files (alarm message), refer to **Tag Reference Manual**.

### ■ UNSUPPORTED TAG IN SCREEN DATA

This error message shows a list of the tag(s) being used that are not supported by the current GP version. The user must re-do their display screens so that they correspond with those supported by this GP.



For details about tags, refer to *Tag Reference Manual*.

### ■ PLC NOT CONNECTED (02:FF) (02:F7)

Appears when either communication with the PLC has stopped for more than 60 seconds, when there is a data transmission timeout error, or when there is excessive noise.

Check the data communication cable's wiring and confirm that all connectors are securely attached.

### ■ PLC NOT RESPONDING (02:FE)

Displays when there is a Reply Timeout Error, or when there is excessive noise.

A list of possible causes and solutions is shown below.

CAUSES	SOLUTION
The Host (PLC) is not turned ON.	Turn the Host (PLC)'s power switch ON.
The GP INITIALIZE area's settings (Setup I/O, PLC Settings, etc.) are not correct.	Correct the GP's INITIALIZE settings so that they agree with the current Host (PLC) and data communication cable settings/specifications.
The Host (PLC) and/or GP's start-up process was incorrect.	After unplugging both the Host (PLC) and the GP, turn the Host (PLC)'s power ON first, wait 2 to 3 seconds, then connect the GP's power cable.
The data communication cable was not connected properly.	Confirm that the data communication Cable's wiring and connections are all correct.

### ■ RECEIVE DATA ERROR (02:FD)

This error occurs due to one of the following reasons:

- There is a data reception problem
- The designated and actual PLC types are different
- Noise

The first two errors will appear when:

- The data communication cable is disconnected while the GP is operating.
- During normal data communication is taking place, and the GP's power cable is disconnected, then reconnected.

In either of these cases, simply retransmit the previous data.

When the error is a result of noise, correct any improper connections and/or install a noise filter.

## RUN and Errors

### ■ GP STATION NO. DUPLICATION ERROR (02:F9) n:1

This error will appear for one of two reasons:

- The current GP's station number is the same as another GP's station number. Check that all the GP station numbers are unique.
- During normal data communication, the PLC's power was turned OFF and then ON. In this case, restart both the PLC and the GP.

### ■ NETWORK ADDRESS ERROR (02:F8) n:1

The SIO address used for the current GP is different from that used for other GPs. Check that all the addresses used for the GPs are unique.

### ■ PLC COM. ERROR

Appears when the address used for a tag(s) exceeds the address range(s) used on the Host (PLC) side. Check the Error Number that follows this message and use the following table to find a solution.

### ◆ PLC COM. ERROR ( 02 : x x)

0 2 : x x

Error Code (See table below)

Constant Value

Error #	Cause	Solution
FC	(M to M type) There is a data format problem with the message received.	Check the data being transferred from the Host (PLC).
FB	A tag address, a trend graph data storage address, or an alarm message address is outside of (greater or less than) the allowable range. (address range error)	* When using a Memory to Memory (M to M) connection, enter an address that is within the System Area (0 to 2047)'s designated range, then resend the data. * When using a Siemens series PLC, set up the PLC's data block in the System Data area.
FA	Address range error	Set the addresses so they are within the allowable device address range.
53	With a Matsushita Electronics PLC, when too many tags are used on the screen the PLC cannot receive screen data.	Reduce the number of screen tags.
51	Tag addresses, Trend graph data storage addresses, Alarm message registration addresses, etc. do not exist in the PLC's internal memory. (With a Fuji Electric Co. PLC)	Be sure all addresses have been created within the Fuji PLC's device ranges.
Others	The Error Number displayed will vary depending on the type of PLC used. Look up the error number's meaning in the PLC maker's manual or, contact the PLC maker for information and support.	



- Disregard the above table's data if Error Number **51** appears and you are using a PLC other than that made by the Fuji Electric Co. Look up the error's explanation in your PLC manual and follow the instructions given there.
- Disregard the above table's data if Error Number **53** appears and you are using a PLC other than that made by Matsushita Electronics. Look up the error's explanation in your PLC manual and follow the instructions given there.
- In Hitachi's HIDIC H (HIZAC H) Series, the error code is divided into 2 bytes, whereas the GP's Error Number is composed of 1 byte codes.

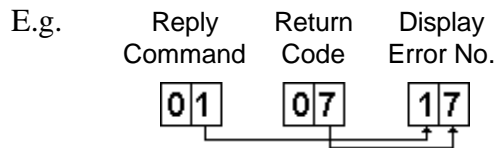

When the displayed error number is 8\*, or 5\*, use only the left column number as the error number.

- In Toshiba's PROTECT Series, the Error Code is 4 digits long; on the GP, Error Numbers are converted to and displayed as Hexadecimal.

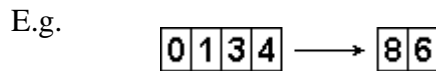

- With the Allen-Bradley PLC-5 and SLC-500 Series PLCs, the EXT/STS error codes have been re-mapped to start at D0 HEX, so that they will not conflict with other error codes. When looking up the error number in the PLC manual, subtract D0 h from the GP error code to get the manual's error code/value.

E.g.

GP Error Code	PLC Error Code
D1	→ 01
EA	→ 1A

**■ SCREEN MEMORY DATA IS CORRUPT**

Displays when corrupted screen files cause the screen memory data checksum to not match.

Error codes, as shown below, appear just after the error message. Use these codes and their accompanying information to diagnose the screens that have errors. When a screen file has become corrupted, delete that file and make a new one (or use a backup copy, if available).

**◆ SCREEN MEMORY DATA IS CORRUPT ( x x x x : x x x x )**

**X X X X : X X X X**

The Screen Number that has an error.  
(Displays only one error per Screen Number.)

The number of screens  
that have errors (Decimal)

### ■ CLOCK SET UP ERROR

This message displays when the backup battery for the GP's internal clock is dead. If the battery is incorrectly replaced, however, the battery may explode. To avoid this danger, please consult with your local GP distributor when the battery needs replacement.

After changing the backup battery, be sure to reset the internal clock.



Refer to *Chapter 5, "INITIALIZE"*



The life span of the backup battery depends on the ambient temperature and the amount of current being charged and used. The table below gives a general indication of how long this battery will last.

Battery Temperature	40°C or less	50°C or less	60°C or less
Expected Life Span	more than 10 yrs.	more than 4.1 yrs.	more than 1.5 yrs.

### ■ SCREEN TRANSFER ERROR

Displays when an error occurs during data transmission from the screen editor (User's PC) to the GP panel. Try re-transmitting the screen data.

### ■ THE MAXIMUM NUMBER OF TAGS (128) HAS BEEN EXCEEDED.

When a tag is added to a screen and it exceeds the maximum number of tags allowed for that screen, it becomes invalid. In other words, the last tag (i.e. the last tag added) in the list of tags displayed on the screen becomes invalid. However, if "Registered (Library) screens" and "Called screens" are brought into (called up to) a base screen, the tag that exceeds this limit then becomes invalid. If multiple tags are displayed on a single screen, the last tag to become invalid will be as follows:

1. The last screen in the list of registered (Library) screens called that exceeds the tag limit becomes invalid.
2. The last screen in the list of called screens that exceeds the tag limit becomes invalid.

Check which tag has become invalid and reduce the number used.



### ■ OBJ. PLC HAS NOT BEEN SETUP (02:F9)

The host PLC setup in the GP's INITIALIZE Screen does not match the PLC in use. Use the Error Code that follows the error message to select the proper PLC type in the GP and correct the INITIALIZE area's setup data.

### ◆ OBJ. PLC HAS NOT BEEN SETUP ( x x )

X X

The PLC number (Hexadecimal)  
currently written to the System File  
(See table below)

#### <List of PLCs corresponding to error codes>

PLC #	PLC TYPE	PLC #	PLC TYPE
0	SYSMAC - C	20	SIEMENS S5 135-115
1	MELSEC - AnN (Link)	21	SIEMENS S5 3964(R) protocol
2	NEW SATELLITE JW	22	Allen Bradley PLC-5
3	FA500 With GP-PRO/PB III: Use FACTORY ACE	28	Allen Bradley SLC500
4	MICREX-F	63	FA500M n:1 SIO With GP-PRO/PB III: Use FACTORY ACE n:1 transmission
6	TOYOPUC-PC2	66	GP FANUC 90SNP
7	MEWNET-FP	67	HIZAC EC
8	HIDIC-S10	68	IDIC 1
9	Memocon-SC	69	IDIC 2
B	MELSEC-AnA (Link)	6A	IDIC 3
D	SYSMAC-CV	6B	FANUC Power Mate
E	PROSEC EX2000	6C	MICRO3
10	HIZAC H	81	MELSEC-AnN (CPU)
11	MELSEC-FX	8B	MELSEC-AnA (CPU)
12	MELSEC-F2	0C	KOSTAC SR21/22
14	KOSTAC SG8	6D	KEYENCE
15	PROSEC T	1C	MELSEC-QnA (LINK)
16	MEMORY LINK (SIO Type)	1D	MELSEC-QnA (CPU)
18	FLEX-PC	6F	FLEX-PC (CPU)
1B	TC200	6E	SELMART
1F	SIEMENS S5 90-115		

# Maintenance

This chapter describes how to clean your GP, and provides a list of inspection items.

## 7-1 Regular Cleaning

### ■ Cleaning the Display

When the GP screen's surface or border becomes dirty, soak a soft cloth in water with a neutral detergent, wring the cloth tightly and wipe off the display.

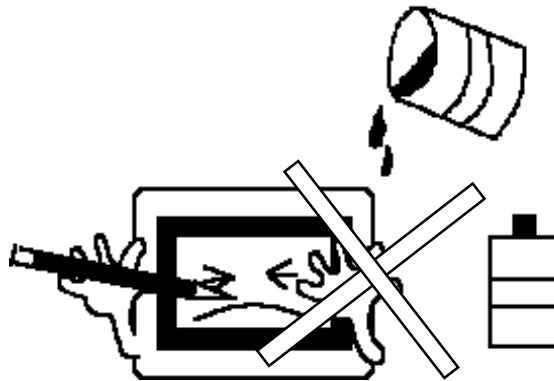

- Do not use paint thinner, organic solvents, or strong acid compounds to clean the GP.
- Do not press the touch-screen panel with hard or pointed objects, such as a mechanical pencil, since it may damage or scratch the surface.

### ■ Replacing the Data Transfer Cable's Moisture Resistant Gasket

This small gasket provides a seal around the Data Transfer Cable and prevents water and dirt from entering the GP's case.



When this gasket has been used for a long period of time, it may have scratches or dirt on it and may have lost much of its water resistance. As a result, be sure to change this seal periodically (or when scratches or dirt become visible).

## 7-2 Periodic Check-up

To maintain your GP in its best condition, please check the following points periodically.

### ■ Inspection Items:

#### Surrounding Environment

Is the temperature within the allowable range? (0 to 40 ° Celsius)

Is the humidity within the specified range? (20 to 85%RH)

Is the atmosphere free of corrosive gas?

- When the GP unit is mounted into a panel, the surrounding temperature refers to the temperature inside the cabinet.

#### Electrical Specifications

Is the input voltage appropriate? (20.4 to 27.6VDC)

#### Attachments

Are all cables connected securely?

# Index

## Symbols

1:1 ..... 5-1, 5-13

## A

Alarm Display ..... 5-3

## B

Bar Code Reader ..... 1-3

## C

### Cable

Connection ..... 1-2

Downloading Cable ..... 1-3, 4-7

Mitsubishi PLC Procon I/F ..... 1-3

Mitsubishi Programming Port I/F ..... 1-5

Multi-link ..... 1-5

RS-232C ..... 1-3, 1-5

RS-422 ..... 1-3, 1-5

Siemen's Programming Port I/F Connection Cable  
1-5

CCU ..... 5-14

Change Screen ..... 5-3

### COMMUNICATION SETUP

RECEIVE TIMEOUT ..... 5-12

RETRY COUNT ..... 5-12

Connection Part ..... 5-15

Cover Sheet ..... 1-4

### CUSTOMIZE SETUP

GP TOUCH MONOPOLIZE ..... 5-18

MONOPOLIZE TIME ..... 5-18

PLC PRIORITY ..... 5-17

## D

Data Device Storage Order ..... 5-7

DISPLAY PATTERN ..... 6-10

Downloading Cable ..... 4-7

## E

Environmental Shield ..... 7-1

Equipment. *See* Optional Equipment; System Structure

### Error Messages

CLOCK SET UP ERROR ..... 6-19

GP STATION NO. REPEATED ..... 6-17

ILLEGAL ADDRESS IN SCREEN DATA .... 6-15

INCORRECT STORAGE INFORMATION AD-  
DRESS ..... 6-17

OBJ. PLC HAS NOT BEEN SETUP ..... 6-20

PLC COM. ERROR ..... 6-18

PLC NOT CONNECTED ..... 6-16

PLC NOT RESPONDING ..... 6-17

RECEIVE DATA ERROR ..... 6-17

SCREEN MEMORY DATA IS CORRUPT ... 6-19

SCREEN TRANSFER ERROR ..... 6-20

SYSTEM ERROR ..... 6-15

UNSUPPORTED TAG IN SCREEN DATA .. 6-16

ESC Key ..... 4-6

## F

FORCE RESET ..... 5-10-5-11

Force Reset ..... 4-2

FRAME BUFFER ..... 6-10

## G

Global Window ..... 5-6

### GLOBAL WINDOW SETUP

DATA FORMAT ..... 5-7

GLOBAL WINDOW ..... 5-6

GLOBAL WINDOW ACCESS ..... 5-6

REGISTRATION NO. (1-256) ..... 5-7

### Graphic Panel

Auxiliary Input/Output ..... 2-5

Caution ..... iv

Cleaning ..... 7-1-7-2

Clock ..... 2-3

Display ..... 2-5

Display Functions ..... 2-2

Electrical Specifications ..... 7-2

Environment ..... 7-2

GP-H70 External Dimensions ..... 2-11

Installation Brackets ..... 2-11

Installation Dimensions ..... 2-11

Interface ..... 2-3

Maintenance ..... 7-1

Names and Functions of parts ..... 2-9

Package Contents ..... ix

Periodic Check-Up ..... 7-2

Screen Memory ..... 2-3

Serial Interface ..... 2-5

Temperature .....	7-2	STATION SETUP .....	5-18
Tool Connector .....	3-2		
Touch Panel .....	2-5		
<b>H</b>		<b>R</b>	
Hitachi		RS-232C .....	2-4, 4-7
HIDIC-S10 alpha Series .....	5-17	RS-232C Port .....	1-2
<b>I</b>		RS-422 .....	2-4
INITIALIZE .....	4-3, 5-1	RS-422 Connector .....	1-3
Standard Operations .....	4-4-4-5	RS-422 Port .....	1-2
INITIALIZE MEMORY .....	5-19	Rubber Gasket .....	7-1
INPUT PORT .....	6-10	RUN .....	4-3
<b>K</b>		<b>S</b>	
K-tag .....	5-8	SCREEN DATA TRANSFER .....	4-3
<b>L</b>		Screen Saver Function .....	5-3
Local Window .....	5-5	SELF-DIAGNOSIS .....	4-3, 6-10
<b>M</b>		DISPLAY PATTERN .....	6-11
Main Menu .....	4-4	FRAME BUFFER .....	6-11
Memory Loader .....	1-3	INPUT PORT .....	6-12
Mitsubishi PLC A-Series		INTERNAL FEPROM CHECKSUM .....	6-11
2 Port Adapter .....	1-2	KEYBOARD LOOP BACK .....	6-11
<b>N</b>		SIO CHECK .....	6-12
n:1 .....	5-1, 5-14, 5-15-5-16	DTR CHECK .....	6-12
NETWORK INFORMATION ADDRESS .....	5-15	RS-422 CHECK .....	6-13
<b>O</b>		RTS CHECK .....	6-12
Off-line Mode .....	4-1, 6-1	Standard Operations .....	4-5-4-7
Optional Equipment .....	1-3	TOUCH PANEL .....	6-11
<b>P</b>		Serial Interface .....	1-2, 1-5, 2-4
PLC PRIORITY		SET Key .....	4-6
Display Priority and Operation Priority Speed Diff		SET UP I/O .....	5-11
5-17		COMMUNICATION SETUP .....	5-13
PLC SETUP .....	5-13	SET UP SIO .....	5-10
CUSTOMIZE SETUP .....	5-17	SET UP TOUCH PANEL .....	5-13
SET UP OPERATION SURROUNDINGS (n:1) ..	5-14	SET UP OPERATION SURROUNDINGS	
SET UP OPERATION SURROUNDINGS (1:1) ...	5-13	STARTING ADDRESS OF SYSTEM DATA AREA	
		5-16	
		SYSTEM AREA--READING AREA SIZE .....	
		5-16	
		UNIT NO. ....	5-13, 5-14
		SET UP SCREEN .....	5-25
		FONT SETTING .....	5-26
		INITIAL SCREEN NO. ....	5-20
		KANJI FONT QUALITY .....	5-21
		ON-LINE ERROR DISPLAY .....	5-20
		SET UP SIO .....	5-10
		COMMUNICATION FORMAT .....	5-11
		CONTROL .....	5-12
		DATA LENGTH .....	5-12

# Index

PARITY .....	5-12
SET UP TIME .....	5-24
SET UP TOUCH PANEL	
BRIGHTNESS ADJUSTMENT .....	5-12
CONTRAST ADJUSTMENT .....	5-12
FORCE RESET .....	5-10
TOUCH OPERATION MODE .....	5-10
SIO CHECK MENU .....	6-10
Specifications	
Electrical .....	2-1
Environmental .....	2-1
Other Items .....	2-2
STATION SETUP	
NETWORK INFORMATION ADDRESS .....	5-18
STATION NO. ....	5-19
Storage Order. <i>See</i> Data Device Storage Order	
Symbols .....	x
SYSTEM AREA SETUP	
System Area Size .....	5-4
SYSTEM ENVIRONMENT SETUP .....	5-3
CHARACTER STRING DATA SETUP .....	5-7
GLOBAL WINDOW SETUP .....	5-6
SYSTEM AREA SETUP .....	5-4
SYSTEM SETUP .....	5-3
SYSTEM SETUP	
BUZZER TERMINAL OUTPUT .....	5-3
DATA TYPE OF SCREEN NO. ....	5-4
PASSWORD (0-9999) .....	5-3
STAND-BY MODE TIME (0-255) .....	5-3
START TIME (0-255) .....	5-3
TOUCH BUZZER SOUND .....	5-3
System Design .....	1-2

## T

Termination Resistor .....	6-7
TOOL CONNECTOR .....	3-2
Touch Screen .....	2-4
Touch Screen Cover .....	1-3
Transfer Screen Data .....	4-9
Troubleshooting .....	6-3
<i>See also</i> Error Messages	
No Display .....	6-4
The Touch Panel Does Not Work .....	6-9
Would Not Communicate .....	6-7

## V

Verification Part .....	5-16
-------------------------	------

## W

Wiring .....	3-1
Grounding .....	3-1
Word Byte LH/HL Order .....	5-7

